



DWC-MB45Wi650T



Default Login Information: admin | admin

When logging into the camera for the first time, you will be prompted to set up a new password. You can set the new password using the DW® IP Finder™ software or directly from the camera's browser menu.

WHAT'S IN THE BOX

Quick setup and download guide		1	Screws and plastic anchors - 4pcs		1 set
Mounting template		1	Hex Allen wrench		1
Test video cable		1	Waterproof cap		1 set

NOTE: Download all your support materials and tools in one place

- Go to: <http://www.digital-watchdog.com/resources>
- Search your product by entering the part number in the 'Search by Product' search bar. Results for applicable part numbers will populate automatically based on the part number you enter.
- Click 'Search'. All supported materials, including manuals and quick start guide (QSGs) will appear in the results.



Attention: This document is intended to serve as a quick reference for initial set-up. It is recommended that the user read the entire instruction manual for complete and proper installation and usage.

STEP 1 - PREPARING TO MOUNT THE CAMERA

- The mounting surface must bear five times the weight of your camera.
- Do not let the cables get caught in improper places or the electric line cover to be damaged. This may cause a breakdown or fire.
- Using the mounting template sheet or the camera itself, mark and drill the necessary holes in the wall or ceiling.

STEP 2 - CABLING THE CAMERA TO EXTERNAL DEVICES

Pass the wires through and make all necessary connections. See STEP 4.

- NETWORK CONNECTIONS - Using a PoE Switch or PoE Injector,** connect the camera using an Ethernet cable for both data and power.
- NETWORK CONNECTIONS - Not using PoE Switch or PoE Injector,** connect the camera to the switch using an Ethernet cable for data transmission and use a power adapter to power the camera.

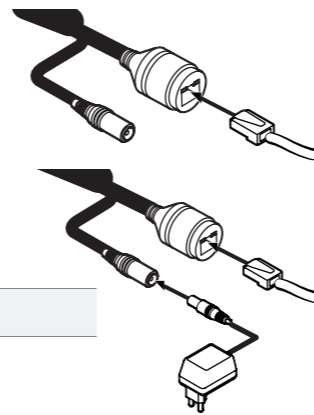

Power requirements	Power consumption
DC12V, PoE (IEEE 802.3af class 3). Adapter not Included.	DC12V Max 9W PoE Max 10.5W

STEP 3 - INSTALLING THE CAMERA

- Once all cables are connected, secure the camera to the mounting surface using the included screws.
- To use the camera's waterproof wiring:
 - Install the LAN cable into **a**.
 - b** will be assembled to **a** with a 1/4 turn.
 - Thread **c** tightly to **b**.

NOTE: To ensure moisture seal, make sure the o-ring is in place between **a** and **b**. In extreme environments use of an outdoor rated sealer is recommended.

NOTE: When using the waterproof cap, crimp the RJ45 connector after passing the cable through the waterproof cap.

- Loosen the pan and tilt screws at the base of the camera's bracket to adjust the camera's view and position.

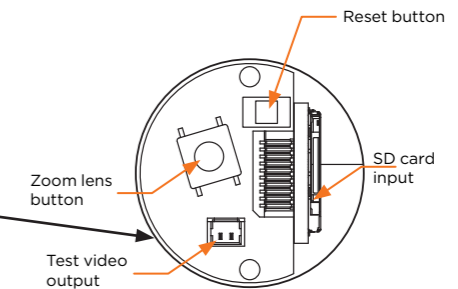
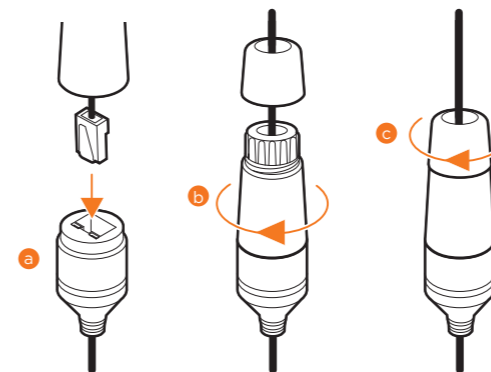
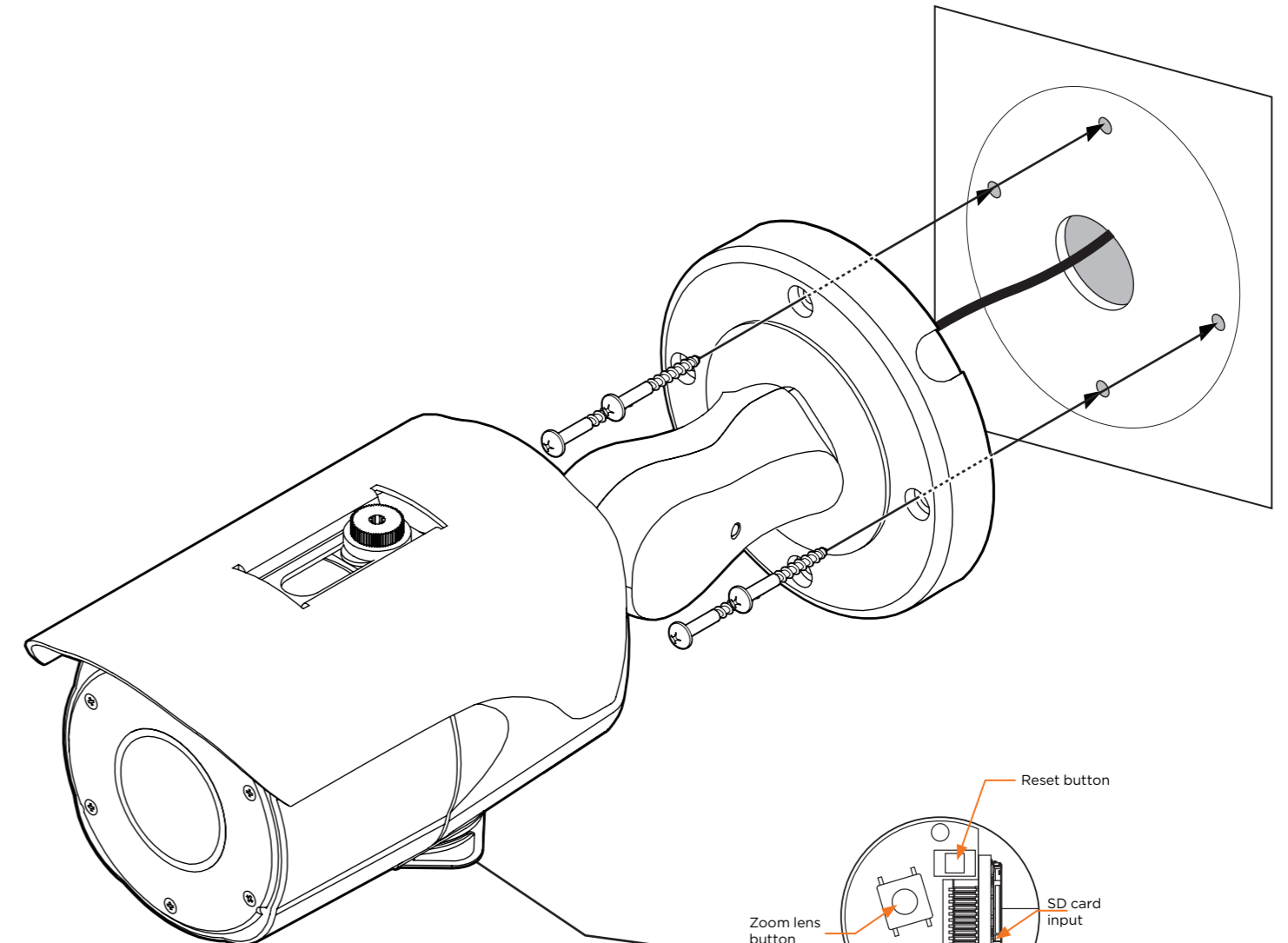

Resetting the camera: To reset the camera, use the tip of a paper clip or a pencil and press the reset button. Pressing the button for five (5) seconds will initiate a camera-wide reset of all the settings, including network settings.

STEP 4 – CABLING

Use the diagram below to properly connect power, network, audio, alarm and sensors to the camera.

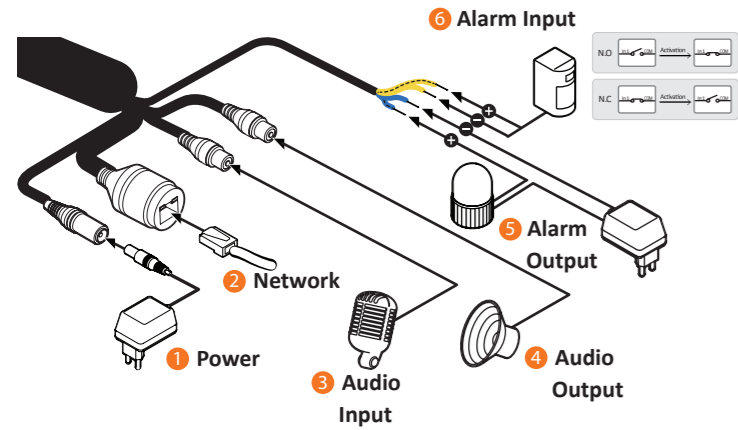

STEP 5 – MANAGING THE SD CARD

- To install the camera's SD Card, locate the SD card slot at the bottom of the camera by unscrewing the con cap.
- Insert class 10 SD/SDHC/SDXC card into the SD card slot by pressing the SD card until clicks.
- To remove the SD card, press the card inward until it clicks to release from the card slot then pull out from the slot.

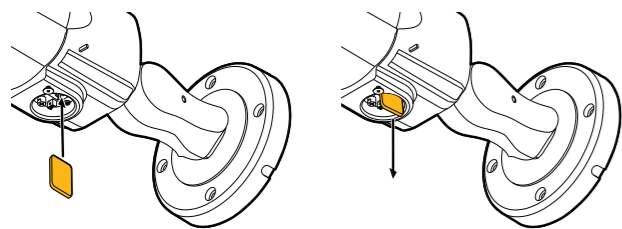

NOTE: Maximum SD Card size supported: 64GB. When inserting the SD card into the card slot, the SD card's contacts should be facing upward, as shown in the diagram.

STEP 6 – DW IP FINDER™

Use the DW IP Finder™ software to scan the network and detect all MEGApix® cameras, set the camera's network settings or access the camera's web client.

The screenshot shows the DW IP Finder software interface. On the left, there are controls for network selection, device filtering, and thumbnail management. The main area displays a table of detected cameras. On the right, there are callouts pointing to specific features in the table and interface.

Thumbnail	Name	IP Address	Model	MAC Address	Netmask	Gateway	Port	DHCP	Version	Ping Test	IP Conf.	Uptime
	DWC-MPTZ30X	192.168.150.34	DWC-MPTZ30X	00:07:0B:19:10:1A	255.255.255.0	192.168.150.1	80	Disabled	1.9.94-X2_release	Ping	Click	--
	DWC-MV44WA	192.168.150.40	DWC-MV44WA	00:0D:F1:21:53:8F	255.255.255.0	192.168.150.1	80	Disabled	A2.01.02_20180619	Ping	Click	28day 14hrs 1mins
	DWC-PZ21M69T	192.168.150.41	DWC-PZ21M69T	00:0D:F1:21:29:21	255.255.255.0	192.168.150.1	80	Disabled	A5.01.03_20180403	Ping	Click	39day 15hrs 54mins
	DWC-PVX16W4	192.168.150.42	DWC-PVX16W4	00:0D:F1:21:5C:AD	255.255.255.0	192.168.150.1	80	Disabled	S2.01.03_20180309	Ping	Click	56day 16hrs 46mins
	DWC-PF5M1TR	192.168.150.61	DWC-PF5M1TR	00:0A:61:1A:00:14	255.255.255.0	192.168.150.1	80	Disabled	-	Ping	Click	--
	DWC-PVF9M2TR	192.168.150.62	DWC-PVF9M2TR	00:0A:61:1A:26:E7	255.255.255.0	192.168.150.1	80	Disabled	-	Ping	Click	--
	DWC-MF4W4	192.168.150.63	DWC-MF4W4	00:0D:F1:20:F8:60	255.255.255.0	192.168.150.1	80	Disabled	A2.01.02_20180619	Ping	Click	28day 14hrs 0mins

Callouts from the right side of the image:

- Firmware version (points to the Version column)
- Camera's uptime (points to the Uptime column)
- Open Device configuration settings (points to the 'Click' button in the IP Conf. column)
- Device's information (points to the 'Click' button in the Ping Test column)

Network Setup

- To install the DW IP Finder™, go to: <http://www.digital-watchdog.com>
- Enter "DW IP Finder" on the search box at the top of the page and press Enter.
- Click on the DW IP Finder from the search result and go to the Software tab. Click on the download icon to download the DW IP Finder installation file.
- Run the installation file and follow the wizard to install the DW IP Finder™. Open the DW IP Finder™ and click 'Scan Devices'. It will scan the selected network for all supported devices and list the results in the table. During the scan, the DW logo will turn gray.
- Select a camera from the list by double-clicking on the camera's image or click on the 'Click' button under the IP Conf. column. The pop-up window will show the camera's current network settings, allowing admin users to adjust the settings as needed.
- To access the camera's web page, click on 'View Camera Website'.
- To save the changes made to the camera's setting, input the username and password of the camera and click Apply. Click "Scan Devices" from the main screen again to display the updated information.

- Select DHCP if the internet service is dynamic IP. This will allow the camera to receive its IP address from the DHCP server.
- Select "Static" to manually enter the camera's IP address, (Sub) Netmask, Gateway and DNS information. * The camera's IP must be set to Static if connecting to DW Spectrum
- Contact your network administrator for more information.

Default TCP/IP information: DHCP

'Port forwarding' has to be set in your network's router for external access to the camera.

Default ID / PW : admin / admin

NOTE: For security purposes, it is highly recommended to change your password after initial setup.

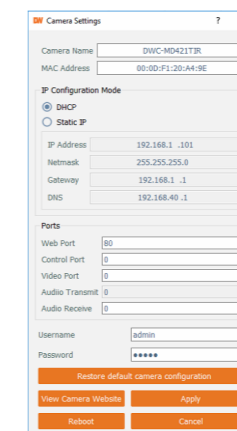

STEP 7 – WEB VIEWER

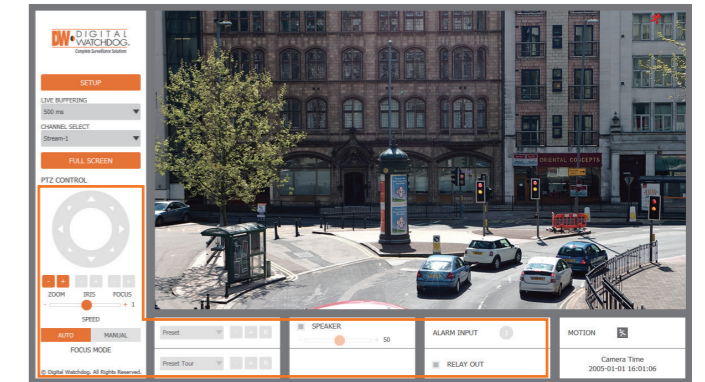

The GUI display may differ by camera models.

*** NOTE:** Some menu options may not be available based on the camera model. See the full manual for more information.

Once the camera's network settings have been setup properly, you can access the camera's web viewer using the DW® IP Finder™.

To open the camera's web viewer:

- Find the camera using the DW® IP Finder™.
- Double-click on the camera's view in the results table.
- Press the 'View Camera Website'. The camera's web viewer will open up in your default web browser.
- Enter the camera's username and password you setup in the DW® IP Finder™. If you did not setup a new username and password via the DW® IP Finder™, you will not be able to view video from the camera. A message will direct you to setup a new password for the camera in order to view video.

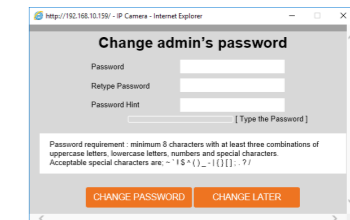

- When accessing the camera for the first time, install the VLC player for web files in order to view video from the camera.

NOTE: 32bit version of VLC player must be installed. If you are using 64bit system, uninstall the previous 64bit version and reinstall using the 32bit version.

NOTE: Please see the full product manual for web viewer setup, functions and camera settings options.