

# MEGApix<sup>®</sup> 2.1MP/1080p bullet IP camera

DWC-MB62DiVT



## *User's Manual* Ver. 11/19

Before installing and using the camera, please read this manual carefully.  
Be sure to keep it handy for future reference.

# Safety Information



## CAUTION

RISK OF ELECTRIC SHOCK.  
DO NOT OPEN.



## CAUTION:

TO REDUCE THE RISK OF ELECTRIC SHOCK, DO NOT REMOVE COVER (OR BACK) NO USER SERVICEABLE PARTS INSIDE. REFER SERVICING TO QUALIFIED SERVICE PERSONNEL.



### Warning

This symbol indicates that dangerous voltage consisting a risk of electric shock is present within this unit.



### Precaution

This exclamation point symbol is intended to alert the user to the presence of important operating and maintenance (servicing) instructions in the literature accompanying the appliance.

## WARNING

To prevent damage which may result in fire or electric shock hazard, do not expose this appliance to rain or moisture.

## WARNING

1. Be sure to use only the standard adapter that is specified in the specification sheet. Using any other adapter could cause fire, electrical shock, or damage to the product.
2. Incorrectly connecting the power supply or replacing battery may cause explosion, fire, electric shock, or damage to the product.
3. Do not connect multiple cameras to a single adapter. Exceeding the capacity may cause excessive heat generation or fire
4. Securely plug the power cord into the power receptacle. Insecure connection may cause fire
5. When installing the camera, fasten it securely and firmly. A falling camera may cause personal injury.
6. Do not place conductive objects (e.g. screw drivers, coins, metal items, etc.) or containers filled with water on top of the camera. Doing so may cause personal injury due to fire, electric shock or falling objects.
7. Do not install the unit in humid, dusty, or sooty locations. Doing so may cause fire or electric shock
8. If any unusual smells or smoke come from the unit, stop using the product. Immediately disconnect the power source and contact the service center. Continued use in such a condition may cause fire or electric shock
9. If this product fails to operate normally, contact the nearest service center. Never disassemble or modify this product in any way.
10. When cleaning, do not spray water directly onto parts of the product. Doing so may cause fire or electric shock

## Precaution

### Operating

- Before using, make sure power supply and all other parts are properly connected.
- While operating, if any abnormal condition or malfunction is observed, stop using the camera immediately and contact your dealer.

### Handling

- Do not disassemble or tamper with parts inside the camera.
- Do not drop the camera or subject it to shock or vibration as this can damage the camera.
- Clean the clear dome cover with extra care. Scratches and dust can ruin the quality of the camera image.

### Installation and Storage

- Do not install the camera in areas of extreme temperature, exceeding the allowed range.
- Avoid installing in humid or dusty environments.
- Avoid installing in places where radiation is present.
- Avoid installing in places where there are strong magnetic fields and electric signals.
- Avoid installing in places where the camera would be subject to strong vibrations.
- Never expose the camera to rain or water.

# Important Safety Instructions

1. **Read these instructions.** - All safety and operating instructions should be read before installation or operation.
2. **Keep these instructions.** - The safety, operating and use instructions should be retained for future reference.
3. **Heed all warnings.** - All warnings on the product and in the operating instructions should be adhered to.
4. **Follow all instructions.** - All operating and use instructions should be followed.
5. **Do not use this device near water.** - For example: near a bath tub, wash bowl, kitchen sink, laundry tub, in a wet basement; near a swimming pool; etc.
6. **Clean only with dry cloth.** - Unplug this product from the wall outlet before cleaning. Do not use liquid cleaners.
7. **Do not block any ventilation openings. Install in accordance with the manufacturer's instructions.** - Slots and openings in the cabinet are provided for ventilation, to ensure reliable operation of the product, and to protect it from over-heating. The openings should never be blocked by placing the product on bed, sofa, rug or other similar surfaces. This product should not be placed in a built-in installation such as a bookcase or rack unless proper ventilation is provided and the manufacturer's instructions have been adhered to.
8. **Do not install near any heat sources such as radiators, heat registers, or other apparatus (including amplifiers) that produce heat.**
9. **Do not defeat the safety purpose of the polarized or grounding-type plug.** A polarized plug has two blades with one wider than the other. A grounding type plug has two blades and a third grounding prong. The wide blade or the third prong are provided for your safety. If the provided plug does not fit into your outlet, consult an electrician for replacement.
10. **Protect the power cord from being walked on or pinched particularly at plugs, convenience receptacles, and the point where they exit from the apparatus.**
11. **Only use attachments/accessories specified by the manufacturer.**
12. **Use only with cart, stand, tripod, bracket, or table specified by the manufacturer, or sold with the apparatus. When a cart is used, use caution when moving the cart/apparatus combination to avoid injury from tip-over.**
13. **Unplug the apparatus during lightning storms or when unused for long periods of time.**
14. **Refer all servicing to qualified service personnel. Servicing is required when the apparatus has been damaged in any way, such as power supply cord or plug is damaged, liquid has been spilled or objects have fallen into the apparatus, the apparatus has been exposed to rain or moisture, does not operate normally, or has been dropped.**



## Disposal of Old Appliances

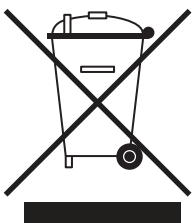

1. When this crossed-out wheel bin symbol is attached to a product it means the product is covered by the European Directive 2002/96/EC.
2. All electrical and electronic products should be disposed of separately from the municipal waste stream in accordance to laws designated by the government or the local authorities.
3. The correct disposal of your old appliance will help prevent potential negative consequences for the environment and human health.
4. For more detailed information about disposal of your old appliance, please contact your city office, waste disposal service or the shop where you purchased the product.



This equipment has been tested and found to comply with the limits for a Class A digital device, pursuant to part 15 of the FCC Rules.

These limits are designed to provide reasonable protection against harmful interference when the equipment is operated in a commercial environment.

This equipment generates, uses, and can radiate radio frequency energy and, if not installed and used in accordance with the instruction manual, may cause harmful interference to radio communications. Operation of this equipment in a residential area is likely to cause harmful interference in which case the user will be required to correct the interference at his own expense.

# Table of Contents

---

## **Introduction**

Product and accessories.....	5
Parts name.....	6

## **Installation**

Disassemble the camera.....	7
Factory reset.....	7
Installation.....	8
Cabling.....	10

## **Network Setup**

DW IP finder.....	11
-------------------	----

## **Web Viewer**

Login to the camera.....	12
GUI overview.....	13

## **Camera Settings**

Settings>Video and audio setup.....	14
Settings>Camera setup> Image adjustment.....	21
Settings>Camera setup> Exposure settings.....	22
Settings>Camera setup> Day and night settings.....	23
Settings>Camera setup> Backlight settings.....	24
Settings>Camera setup> White Balance settings.....	25
Settings>Camera setup> Image enhancement settings.....	26
Settings>Camera setup>Video enhancement.....	27
Settings>Network setup.....	28
Settings>Trigger action setup.....	38
Settings>Event setup.....	41
Settings>Security setup.....	44
Settings>System setup>System information.....	51
Settings>System setup>Firmware.....	53
Settings>System setup>Date and time.....	55
Settings>System setup>DST.....	56
Settings>System setup>Users.....	57
Settings>System setup>System log.....	58
Settings>System setup>Factory reset.....	59
Settings>System setup>Restart.....	60
Settings>System setup>System open source license.....	61

<b>Appendix.....</b>	<b>62</b>
----------------------	-----------

<b>FAQs.....</b>	<b>69</b>
------------------	-----------

<b>Dimensions.....</b>	<b>70</b>
------------------------	-----------

<b>Specifications.....</b>	<b>71</b>
----------------------------	-----------

<b>Warranty.....</b>	<b>72</b>
----------------------	-----------

<b>Limits and exclusions.....</b>	<b>73</b>
-----------------------------------	-----------

# Introduction - Product and accessories

---

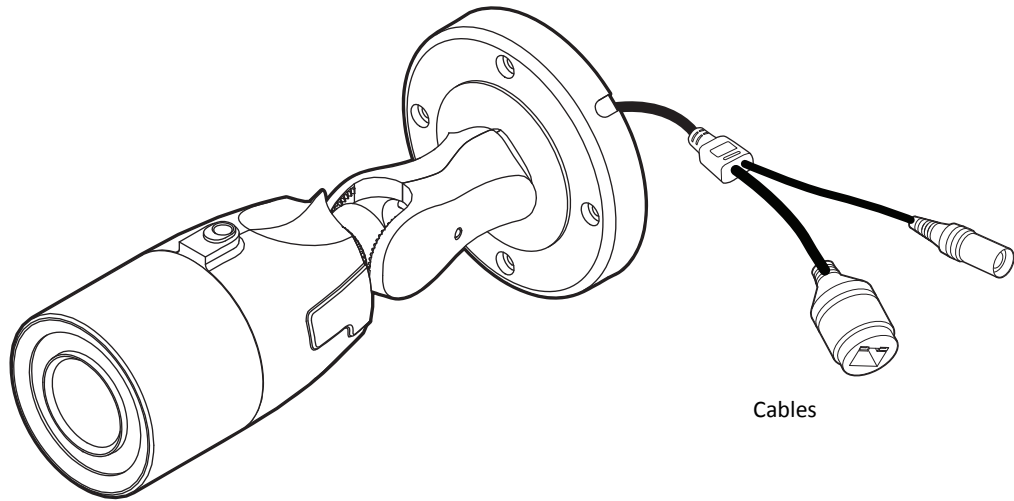

Cables

Camera

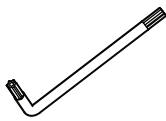

Hex Allen wrench

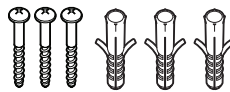

Screws and  
plastic anchors-3pcs

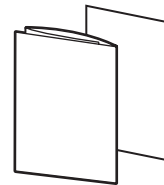

Quick setup guide

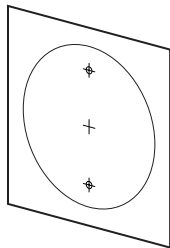

Mounting template

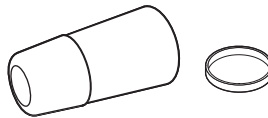

Waterproof cap and gasket

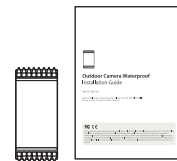

Moisture absorber  
and absorber guide

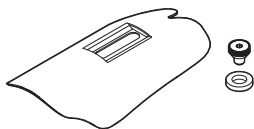

Sunshield cover  
and adjusting  
screws

# Introduction - Part name

---

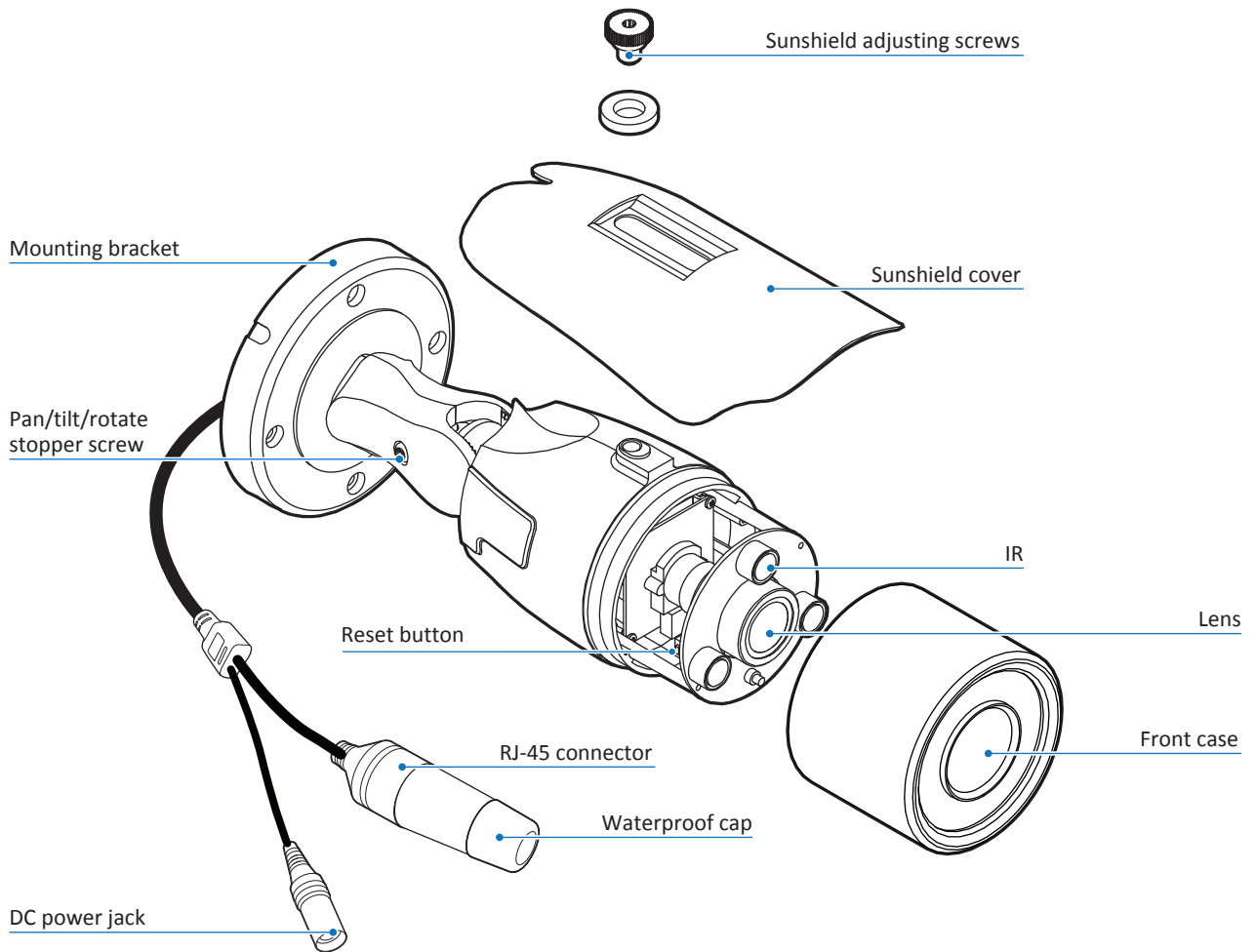

# Installation - Disassemble the camera

---

Before installing your camera, read the following cautions.

1. Make sure the mounting surface can hold up to five times the weight of your camera.
2. Do not let cables get caught in improper places or the electric line cover get damaged. It may cause a breakdown or fire.
3. When installing your camera, do not allow any unauthorized personnel approach the installation site. If you have any valuable things under the place, move them away.

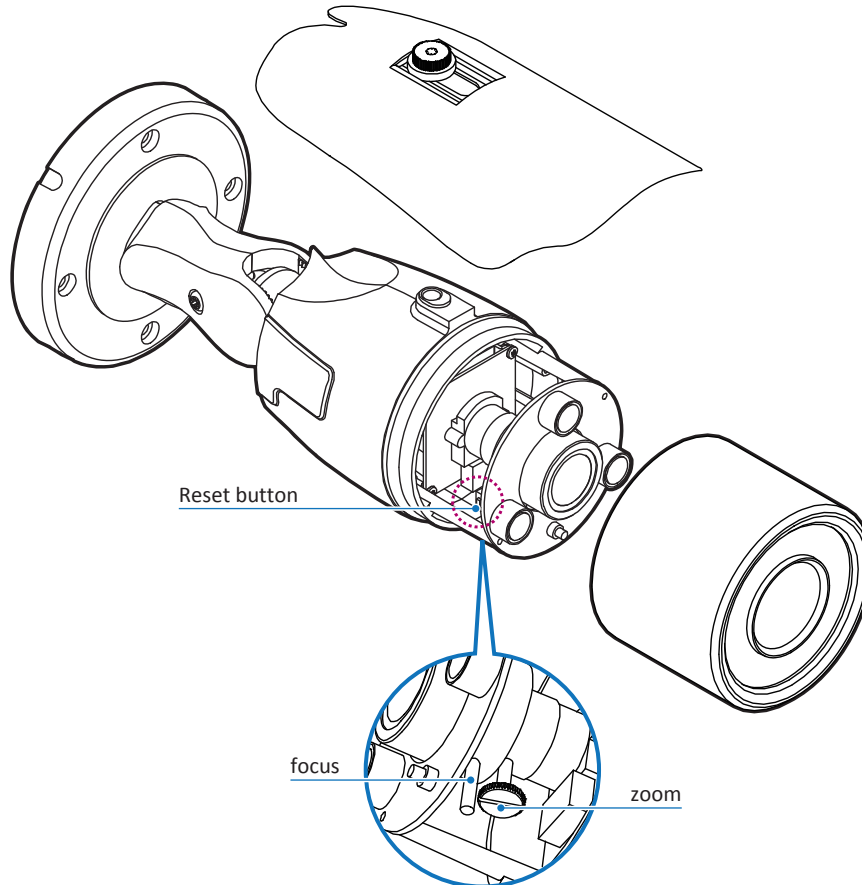

- 1 Remove the sunshield from the camera when adjusting the zoom and focus.
  - 2 Remove the front case by turning it counter-clockwise.
  - 3 Unlock the zoom or focus levers before adjusting the lens.
  - 4 Adjust the zoom and focus by moving the levers to achieve an optimal camera view.
  - 5 Once the adjustments are completed, tighten the zoom or focus lever, taking care not to adjust the zoom/focus position.
  - 6 Close and tighten the front cover and place back the sunshield.
    - ⊗ If the front cover is cross threaded or not tightened correctly, the camera housing will not be weatherproof.
- ⊗ **Reset to the factory default**  
Press the reset button for five (5) seconds to return the camera's settings to their factory default values.
- ⊗ **Warning:**  
Pressing the 'Reset' button will cause all settings data to be lost. If needed, please, make a note for further installation.

# Installation - Installation

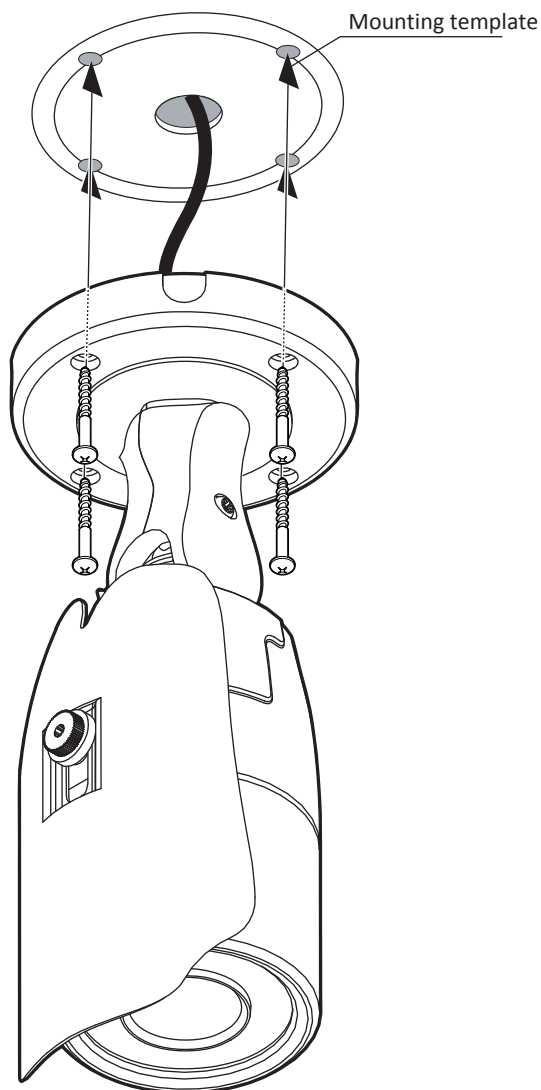

- 1 Using the mounting template or the camera itself, mark and drill the necessary holes on the mounting surface.
- 2 Pass the wires through and make all necessary connections. See section 'Installation - Cabling' for more information.

☒ To use the camera's waterproof wiring:

- a. Install the LAN cable into (a).
- b. (b) will be assembled to (a) with a 1/4 turn.
- c. Thread (c) tightly to (b).

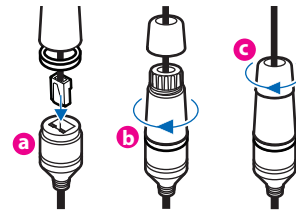

NOTE: To ensure moisture seal, make sure the o-ring is in place between (a) and (b). In extreme environments use of an outdoor rated sealer is recommended.

NOTE: When using the waterproof cap, crimp the RJ45 connector after passing the cable through the waterproof cap.

- 4 Adjust the camera's view and orientation by adjusting the camera's 3-axis bracket. Once the desired view and position has been achieved, tighten the tilt stopper screw back.
- 5 If needed, adjust the camera's zoom and focus using the levers at the camera's base. See 'Installation - Disassemble the camera' for more information.
- 6 Make sure to remove the protective film when the installation is complete and attach the dome cover to the bottom case.



# Installation - Adjusting the camera's angle

---

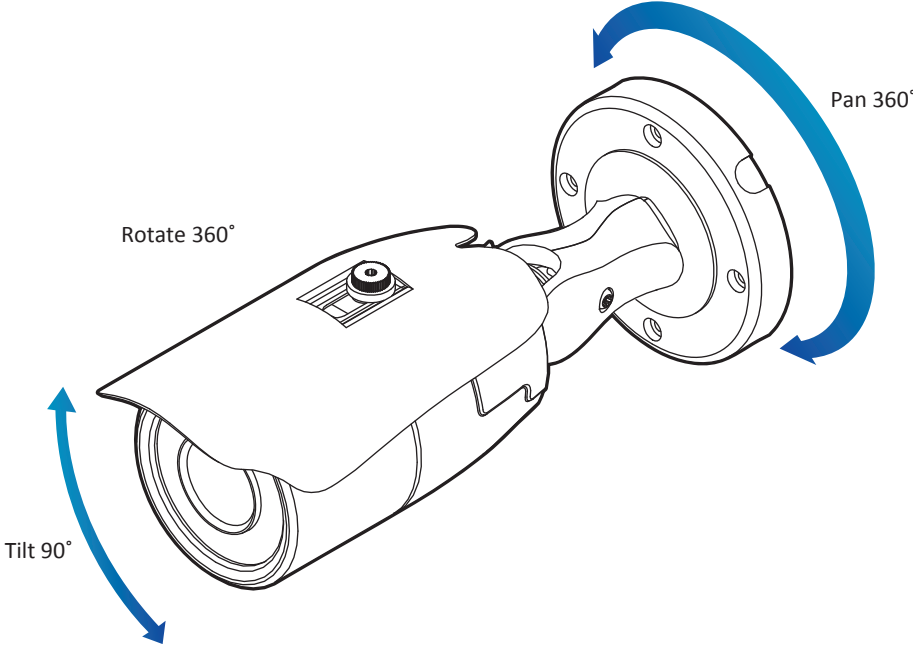

# Installation - Cabling

---

## Two Options

Use a PoE-enabled switch to connect data and power through a single cable and begin viewing and recording images instantly. A non-PoE switch will require an adaptor for power transmission.

### 1. Using a PoE-Enabled Switch

The Camera is PoE-compliant, allowing transmission of power and data via a single Ethernet cable. PoE eliminates the need for the different cables used to power, record, or control the camera. Follow the illustration below to connect the camera to a PoE-enabled switch using an Ethernet cable.

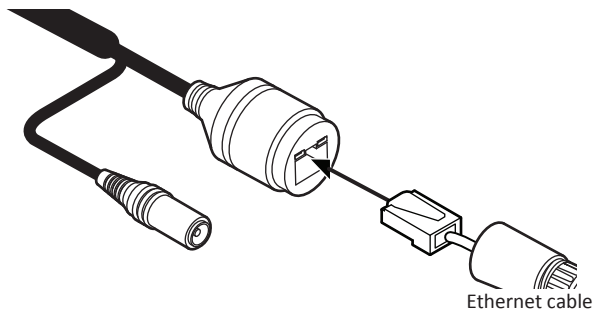

### 2. Using a Non-PoE Switch

If a PoE-enabled switch is not used, use a power adaptor for power transmission and non-PoE switch for data transmission. Follow the illustrations below to connect the camera without a PoE-enabled Switch.

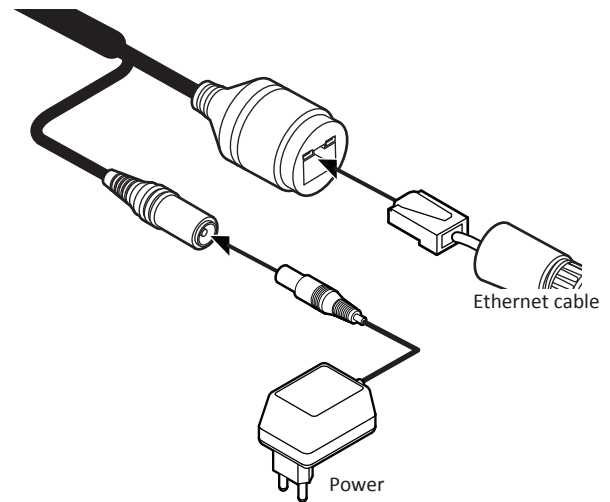

# Network setup - DW IP Finder™

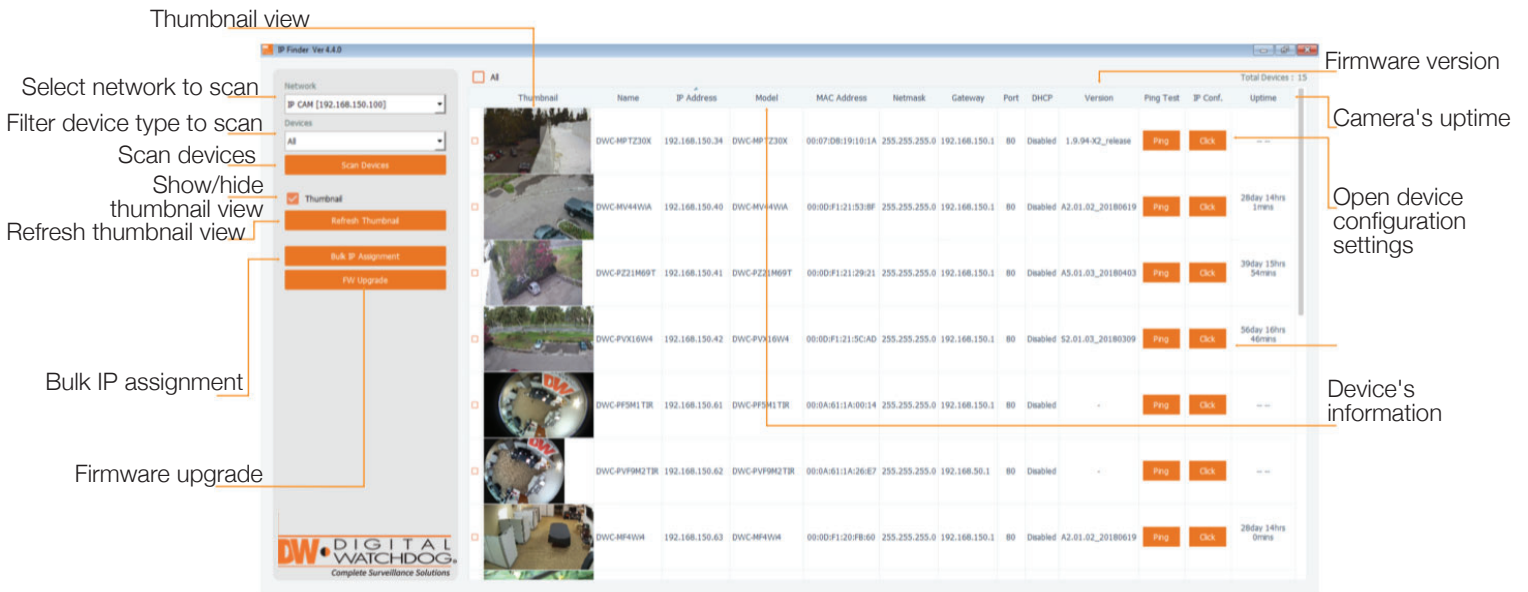

- 1 Go to : <http://www.digital-watchdog.com> and search for 'IP Finder' on the quick search bar at the top of the page.
- 2 The latest IP Finder software will appear in the search results. Click on the link to download the file to your computer.
- 3 The software will scan your network for all supported cameras and display the results in the table. Allow up to 5 seconds for the IP Installer to find the camera on the network.
- 4 You can press the 'Refresh List' to search the network again, or filter the search results by entering a value in the filter box.
- 5 Check the box next to 'Display Camera Thumbnail' to view a JPEG image of the camera's view next to the camera name on supported models.

- i** The default network type of camera is DHCP mode.
- i** If you have a DHCP server, it will automatically set the Camera IP.
- i** Contact your network administrator for more information.

- 6 To save the changes made to the camera's settings, input ID and PW of the camera for authentication.
- 7 If the camera needs to be rebooted after the settings were changed, press the 'Reboot' button. The camera will power cycle and will appear back in the search results once the reboot is complete.

- i** Default ID / PW : admin / admin
- i** For security purposes, it is highly recommended to change your password after initial setup.

- 8 Click 'Save' to save changed values.
- 9 To update the camera's firmware from the DW IP Finder™, click on the firmware tab, upload the firmware file and select the camera to update. You can update multiple cameras at the same time.

# Web viewer screen - Basic screen (default)

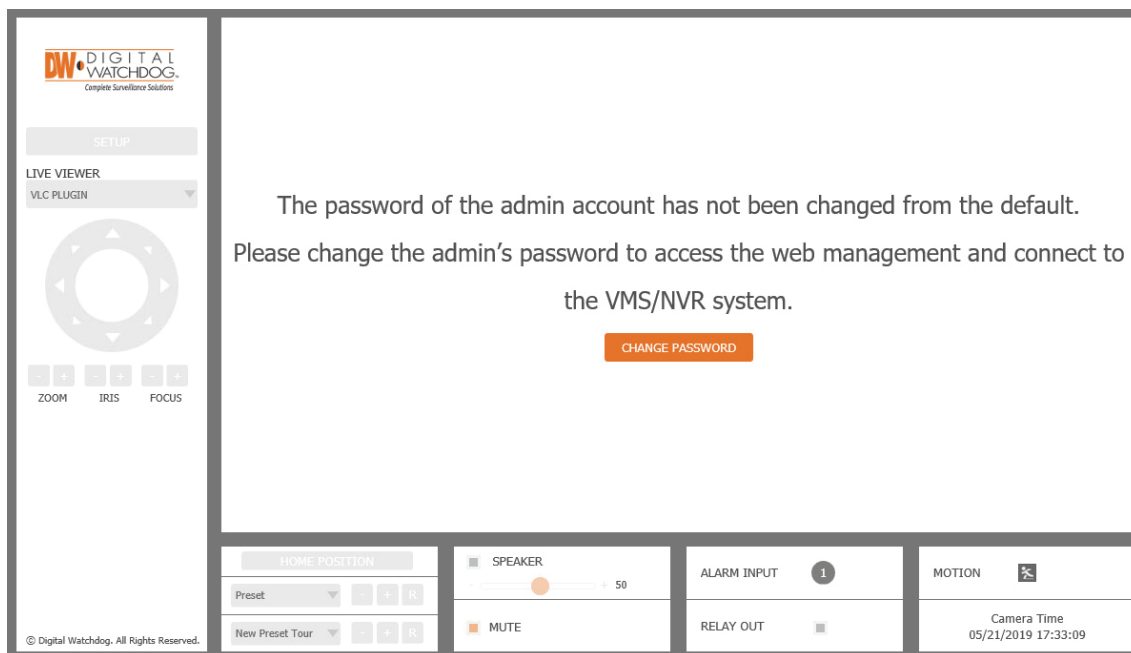

Password change is required at initial connection in factory reset state.

- 1 You cannot see the image, and the setup button is disabled.
- 2 Change the password with the CHANGE PASSWORD button.

**Change admin's password**

Password

Retype Password

Password Hint  [ Type the Password ]

Password requirement : minimum 8 characters with at least three combinations of uppercase letters, lowercase letters, numbers and special characters.  
Acceptable special characters are: - ! \$ ^ ( ) \_ - { } | ; . ? /

- 3 After changing the default password, you must log in again by pressing the RE-LOGIN button.

**The admin's password has been changed.**

**Please re-login.**

**Your time has expired and you have been signed out.**

**Please re-login.**

## ✳ Password Hint Page

- Internet Explorer: Login fail after three failed attempts or click Cancel button.
- Other browsers: Click the 'cancel' button.
- After inputting the user name, press the hint button to see the hint you entered when changing the password.

**PASSWORD HINT**

If you don't remember your password, click on the Password Hint button to see the hint.

User Name

# Web viewer screen - Basic screen

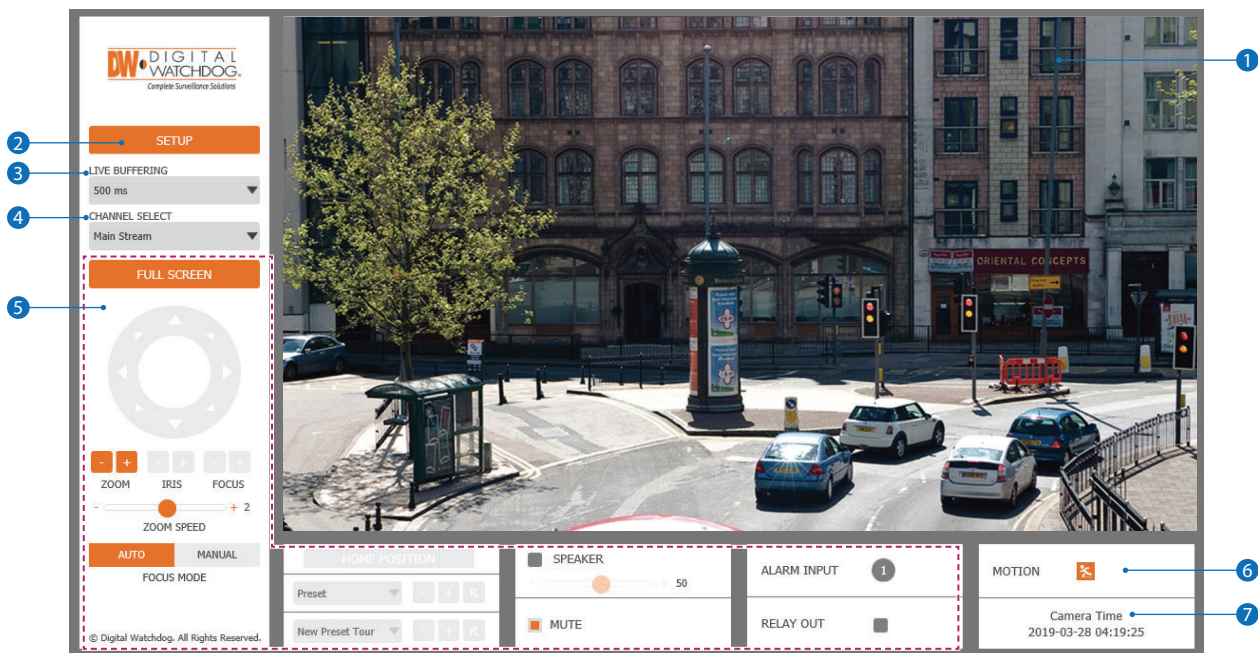

⚠ Web viewer is optimized with IE10 or higher and Firefox.

⚠ If VLC is not installed or the VLC plugin is not supported (Chrome), live buffering and channel select menu will change to the live viewer menu. If VLC is not installed or updated, you can select HTML5(MJPEG) is under live viewer menu to view live video.

1 Live video display. This is the region for live video stream from the camera.

2 setup button. Open the setup page to setup the camera's video, network, events and system settings. See section 'setup' for more information.

3 When the image is choppy due to a bad network connection, you can adjust the buffering settings.

⚠ User will see the delayed images as much as setup time.

4 Channel Select button. Select a stream produced from the camera between Stream 1 ~ 3 to display it in the live view screen.

⚠ Refer 'setup > Video & Audio > Video' to setup the Video Stream.

5 Below menu options may vary based on the camera's model.

---

**PTZ control** - Control the camera's zoom and focus remotely.

---

**Preset** - Not supported.

---

**Speaker control** - Not supported.

---

**Alarm input** - Not supported.

---

**Relay output** - Not supported.

---

6 **Motion** - When the camera detects motion, an indicator will appear on the camera's main view.

⚠ Event alert icon (  ) appears if 'motion detection' is activated in the camera's settings.

7 **Camera Time** - Displays the camera's local time.

# Setup - Video and audio setup

## Video configuration



1 **Detail Page** – Select an item from the menu tree on the left to open additional sub-categories and settings options.

### 2 **Setup breakdown**

#### **Video and audio**

[ VIDEO, OSD, ROI, PRIVACY MASK ]

#### **Camera**

[ IMAGE ADJUSTMENT, EXPOSURE, DAY&NIGHT, BACKLIGHT, WHITE BALANCE, IMAGE, VIDEO ]

#### **Network**

[ STATUS, NETWORK SETTING, AUTO IP, ONVIF, UPNP, DDNS, FTP, SMTP, SNMP, RTSP INFORMATION ]

#### **Trigger Action**

[ ACTION RULES, IMAGE TRANSFER ]

#### **Events**

[ EVENT RULES, MOTION ]

#### **Security**

[ IP ADDRESS FILTER, RTSP AUTHENTICATION, IEEE 802.1x, HTTPS, CERTIFICATES, SERVICE ]

#### **System**

[ INFORMATION, DIAGNOSTICS, FIRMWARE UPDATE, DATE&TIME, DST, USER MANAGEMENT, LOG, FACTORY RESET, RESTART, OPEN SOURCE ]

# Setup - Video and audio setup

## Video configuration

**VIDEO CONFIGURATION**

Stream	Codec	Description
1	H.264	channel1
2	H.264	channel2
3	M-JPEG	channel3

**Codec**

Codec: H.264  
 Description: channel1  
 Resolution: 1920x1080  
 Frame Rate(FPS): 30  
 GOP: 30 [ 1 ~ 120 ]  
 Profile: High  
 Smart Bitrate Control: Off  
 Bitrate Mode: CBR  
 Target Bitrate: 5120 [ 100Kbps ~ 10Mbps ]  
 Extension Option: Off  
 Quality: 5 [ 1 ~ 10 ]

APPLY

- Live video channel setup** - The camera's video can be configured with a combination of codec and resolution. The camera's performance has to be considered when setting multiple channels.
  - ⚠ H.265 (HEVC) codec with higher bitrate may cause the unstable live streaming or reload the webpage.
- Codec** - Choose the video codec. According to the selected codec, the subcategories can be changed automatically.
- Description** - Input additional description about the selected channel. Max. 30 alphabets are allowed(Including space). For the description, English alphabets, numbers and special characters ( - \_ @ . ) can be used.
- Resolution** - Select the video resolution.
  - ⚠ Available resolution differs according to the codec selected.

<Resolution of Video Format>

	1080p/i	720p/i	CIF
NTSC	1920 x 1080	1280 x 720	352 x 288 352 x 240
PAL	1920 x 1080	1280 x 720	352 x 288 352 x 240
- Frame Rate** - Select the maximum Frame Rate.
  - ⚠ Available Frame Rate can be different although same codecs were setup.

# Setup - Video and audio setup

## Video configuration

**VIDEO CONFIGURATION**

Stream	Codec	Description
1	H.264	channel1
2	H.264	channel2
3	M-JPEG	channel3

**Codec**

Codec: H.264  
Description: channel1  
Resolution: 1920x1080  
Frame Rate(FPS): 30  
6 GOP: 30 [ 1 ~ 120 ]  
7 Profile: High  
8 Smart Bitrate Control: Off  
Bitrate Mode: CBR  
Target Bitrate: 5120 [ 100Kbps ~ 10Mbps ]  
Extension Option: Off  
Quality: 5 [ 1 ~ 10 ]

APPLY

- 6 **GOP(Group of Pictures) size** - Setup the number of frames (P-frame) which contain only changed information based on basic frame (I-frame). For areas with lots of movement, the bigger the GOP value is, only the number of P-frames is bigger. As a result, video resolution will be low but 'file size' and bit-rate will be decreased.

⚙️ **GOP(Group of Pictures) size is:**

I-frame and P-frame can be created for H.265 (HEVC), H.264 and MPEG4 video compression. I-frame(=key-frame) means the whole image data for one specific scene of video. P-frame is image data which has been changed information compared to I-frame GOP is made up of one I-frame and corresponding several P-frames. To improve video quality, set the number of P-frames smaller and to decrease image size, set the number of P-frames bigger.

- 7 **Profile** -The profile defines the subset of bit stream features in H.265 (HEVC) or H.264 stream, including color reproduction and additional video compression.

⚙️ H.264: Main, High / H.265 (HEVC): Main

---

**Main** - An intermediate profile with a medium compression ratio. The main profile supports I-frames, P-frames, and B-frames.

---

**High** - A complex profile with a high compression ratio. The high profile supports I-frames, P-frames, and B-frames.

---

- 8 **Smart bitrate control**

---

**Off** - Smart bitrate control function is disabled.

---

**CVBR (framerate priority)** - This Mode is for cameras which do not want any frame drop, but still want to get a lower bitrate. When the target bitrate is set to be very low, events with high motion may appear very noisy.

---

**CVBR (quality priority)** - When the target bitrate is set to be very low, and an event with high motion occurs, LBR will try to drop frames, making the final fps lower, making the output frames to have better quality.

---

**CBR** - This mode is close to traditional security IPCAM, and it is not designed for LBR. It is provided as an option in LBR library to help comparison.

---



# Setup - Video and audio setup

## Video configuration

---

**VIDEO CONFIGURATION**

Stream	Codec	Description
1	H.264	channel1
2	H.264	channel2
3	M-JPEG	channel3

**Codec**

Codec: H.264  
Description: channel1  
Resolution: 1920x1080  
Frame Rate(FPS): 30  
GOP: 30 [ 1 ~ 120 ]  
Profile: High  
Smart Bitrate Control: Off  
Bitrate Mode: CBR  
Target Bitrate: 5120 [ 100Kbps ~ 10Mbps ]  
Extension Option: Off  
Quality: 5 [ 1 ~ 10 ]

APPLY

Callouts: 9 points to Bitrate Mode, 10 points to Target Bitrate, 11 points to Extension Option, 12 points to Quality, 13 points to the APPLY button.

- 9 **Bitrate mode** - Select the bit rate control scheme of video compression from CBR (Constant Bit Rate) or VBR (Variable Bit Rate).

---

**CBR** - To guarantee the designated constant bit rate, the quality of video is controlled in this mode. Therefore, the quality of video is likely to be varying when network traffic is changing.

---

**VBR** - To guarantee the designated quality, the bit rate of video stream is changed in this mode. Therefore, the frame rate of video is likely to vary when network traffic is changing.

---

⚠ This category will not appear if you manually select the camera's codec.

- 10 **Target bitrate** - If bitrate control is set to be CBR, you can set the target bitrate.

- 11 **Extension option**

---

**Off** - Extension option is disabled.

---

**SVC-T On** - The H.264, H.265 (HEVC), SVC (Scalable Video Coding) is a video compression algorithm that enables effective and efficient transmission of video files over low bandwidth networks.

- 12 **Quality** - For VBR control mode, the target quality of video can be setup.

- 13 Click 'Apply' to make above setting effective.

# Setup - Video and audio setup

## OSD configuration

---

**ON SCREEN DISPLAY(OSD) CONFIGURATION**

**1** **Date & Time**  
 Off  On  
Position X  [ 0 ~ 100 ]  
Position Y  [ 0 ~ 100 ]

**2** **User Text**  
 Off  On  
Position X  [ 0 ~ 100 ]  
Position Y  [ 0 ~ 100 ]  
Text

**3** **APPLY**

- 1 Date / Time** - Display the current time.
- 2 User Text** - Output the TEXT entered by the user. Support a maximum of 30 characters.
- 3** Click 'Apply' to make above setting effective.

# Setup - Video and audio setup

## Region of Interest (ROI) configuration

---

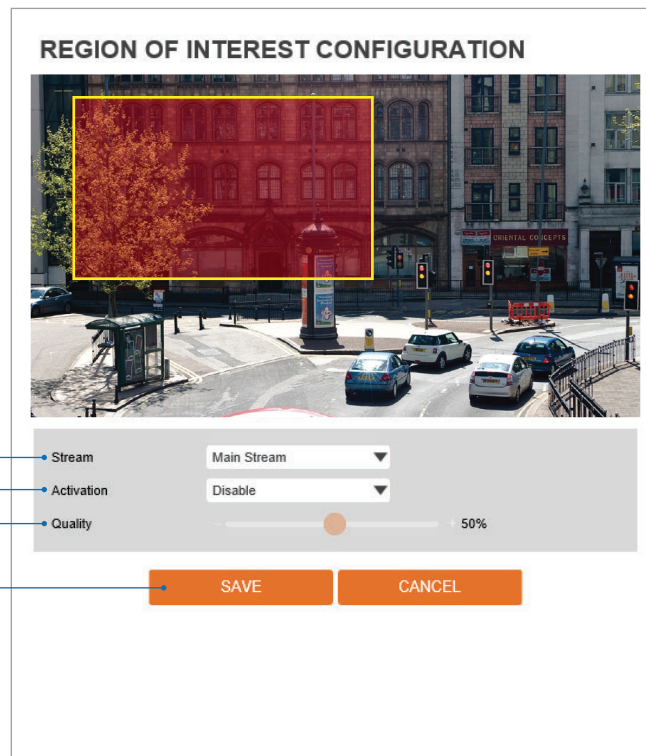

Region of interest function gives much more efficiency picture quality for indicated area to improve picture qualities of movement scene at the same bandwidth.

1 **Stream** - Select the stream.

⊠ Currently it supports only H.264, H.265 (HEVC).

⊠ The function is not supported in MJPEG codec.

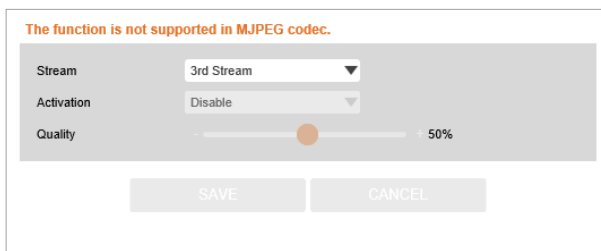

2 **Activation** - The region of interest can be enabled or disabled.

3 **Quality** - Set the quality of the set area.

4 Click 'Save' to save the current settings.

⊠ Click 'Cancel' to return to the previous setting.

# Setup - Video and audio setup

## Privacy mask configuration

---

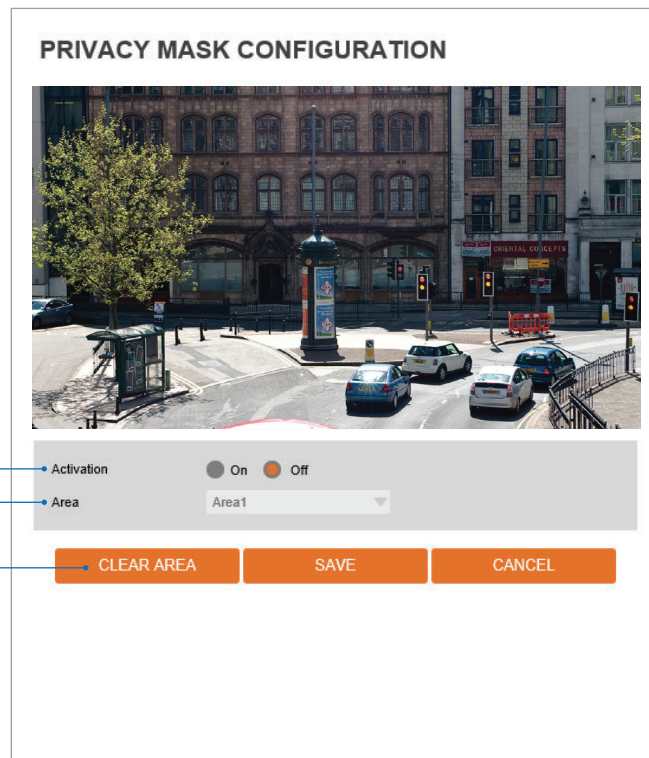

Use this function to mask areas that you want to hide on screen to protect privacy.

- 1 **Activation** - The privacy mask function can be enabled or disabled.
- 2 **Area** - Select the Area1 ~ Area16 and Set the privacy area. Using your mouse, draw on the camera's preview the size and position of the privacy mask.
- 3 Click 'Save' to save the current settings.
  - ⊠ Click 'Cancel' to return to the previous setting.
  - ⊠ Click 'Clear Area' to delete the selected Area1~Area16.

# Setup - Camera setup

## Image adjustment

---

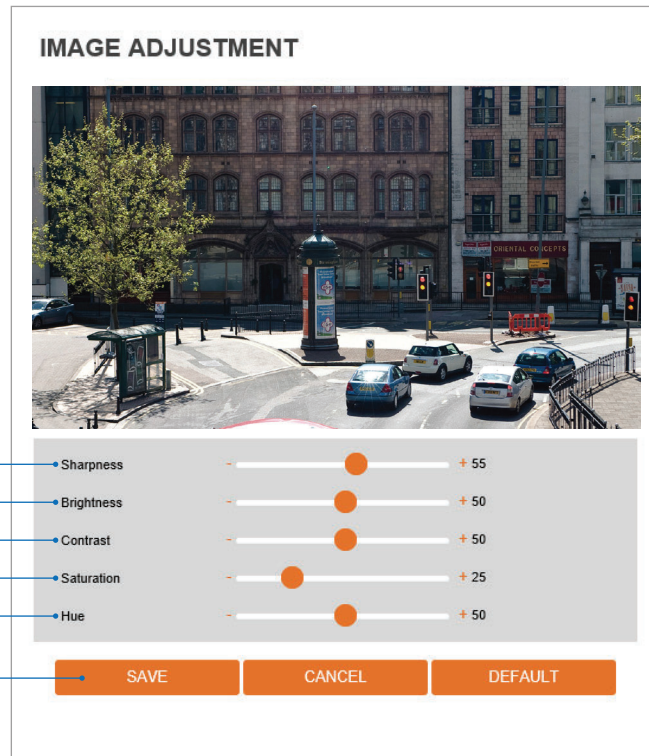

- 1 **Sharpness** - Adjust the image's sharpness to meet your preference. See the results on the camera's preview.
- 2 **Brightness** - Adjust the image's brightness to meet your preference. See the results on the camera's preview.
- 3 **Contrast** - Adjust the image's contrast to meet your preference. See the results on the camera's preview.
- 4 **Saturation** - Adjust the image's saturation to meet your preference. See the results on the camera's preview.
- 5 **Hue** - Adjust the image's hue to meet your preference. See the results on the camera's preview.
- 6 Click 'Save' to save the current settings.
  - ⌘ Click 'Cancel' to return to the previous setting.
  - ⌘ Click 'Default' to settings to the factory defaults.

# Setup - Camera setup

## Exposure settings

---

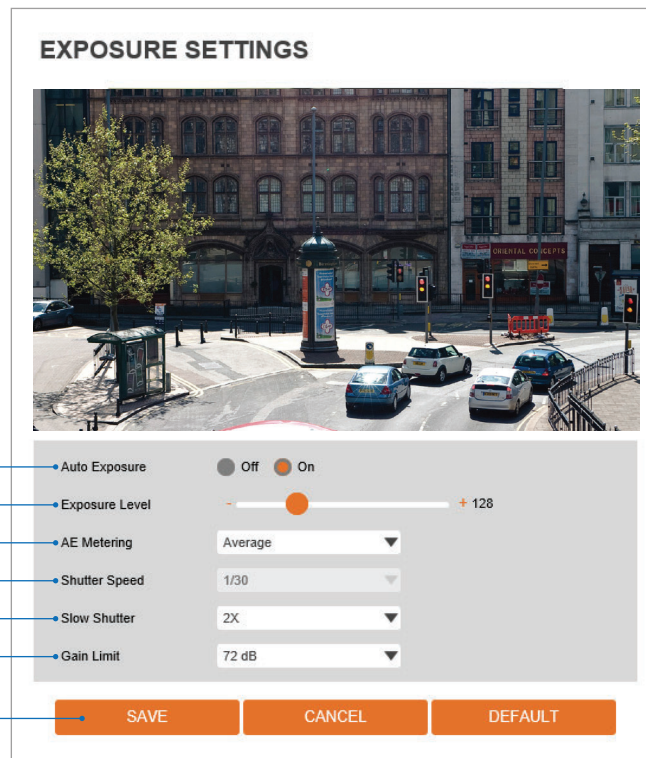

- 1 **Auto Exposure** - Automatic exposure (AE) automatically sets the aperture or shutter speed, based on the external lighting conditions for the photo.
- 2 **Exposure Level** - The higher the value, the image becomes brighter.
- 3 **AE metering** - AE metering mode refers to the way in which a camera determines the exposure.
- 4 **Shutter speed** - If this speed is faster, the moving object can be photographed without the ghost effect. However, picture can be dark if there is insufficient lighting.
- 5 **Slow shutter level** - Slow shutter level lets you adjust the amount of light striking the sensor, and essentially determines when the video sensor sends out its batch of data for processing.
- 6 **Gain limit** - The smaller number makes the darker image.
- 7 Click 'Save' to save the current settings.
  - ⌘ Click 'Cancel' to return to the previous setting.
  - ⌘ Click 'Default' to settings to the factory defaults.

# Setup - Camera setup

## Day and night settings

---

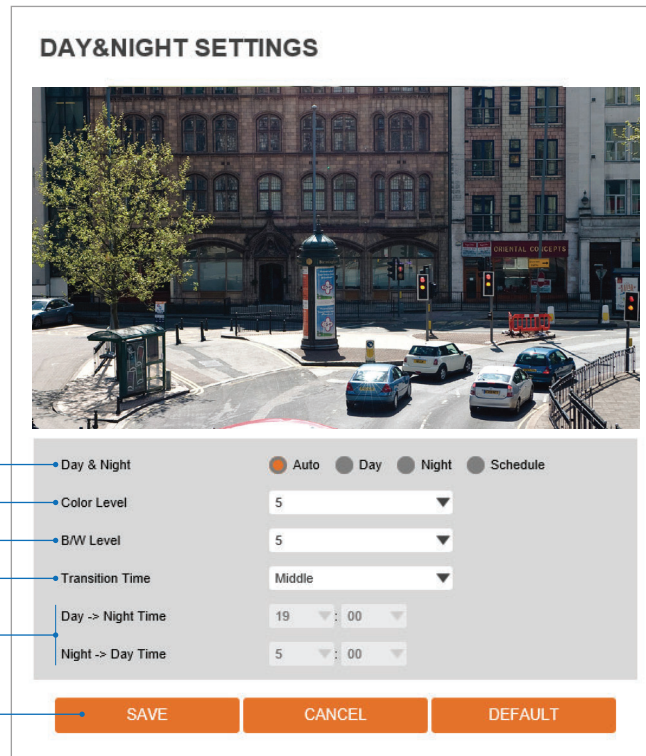

### 1 Day and night

- **Auto:** In this mode, the IR cut filter is removed automatically depending on the light condition around.
- **Day:** In this mode, the IR cut filter is applied to the image sensor all the time. The camera's sensitivity is reduced in low light conditions, but the camera can still produce a clear color reproduction.
- **Night:** In this mode, the IR cut filter on the image sensor is removed all the time. The sensitivity will be enhanced in the dark, but the image is black and white.
- **Schedule:** In this mode, Day / Night mode is converted accordance with the scheduled time.

2 **Color level** - The level of light when the camera switches from night mode to day mode when the day/night mode is set to auto.

3 **B / W level** - The level of light when the camera switches from day mode to night mode when the day/night mode is set to auto.

4 **Transition time** - If the day/night mode is set to auto, set the rate at which the camera switches between the modes.

5 If the day/night is set to schedule, set the time of day when the camera switches between the modes.

6 Click 'Save' to save the current settings.

⌘ Click 'Cancel' to return to the previous setting.

⌘ Click 'Default' to settings to the factory defaults.

# Setup - Camera setup

## Backlight settings

---

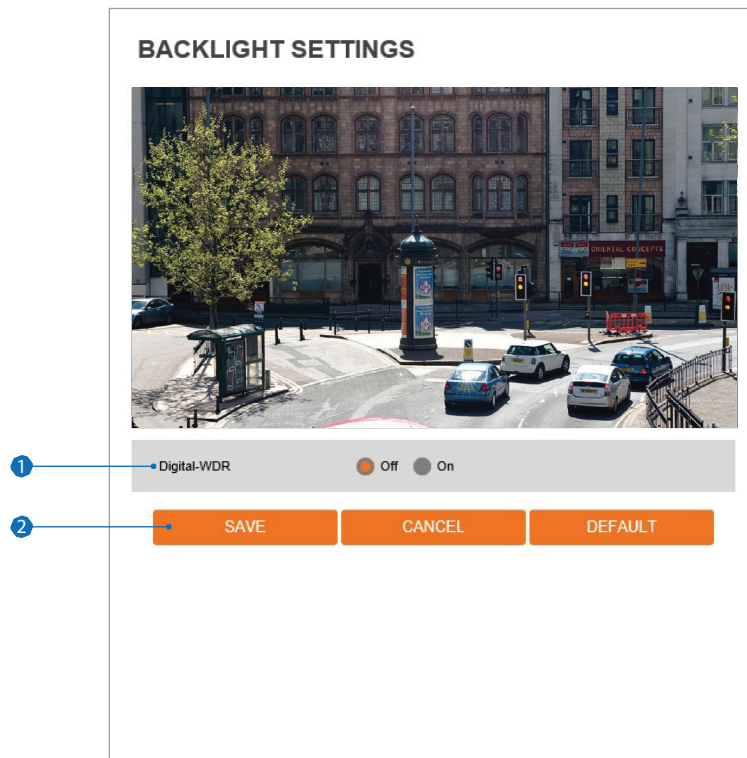

This is a feature used for problematic light conditions where the contrast from light to dark areas is very high.

- 1 **Digital WDR (Digital Wide Dynamic Range)** - The digital WDR function can be enabled or disabled. When enabled, the camera will adjust both over- and under-exposed areas in the camera's view, resulting in a clearer more visible image.
- 2 Click 'Save' to save the current settings.
  - ⚠ Click 'Cancel' to return to the previous setting.
  - ⚠ Click 'Default' to settings to the factory defaults.



# Setup - Camera setup

## White Balance

---

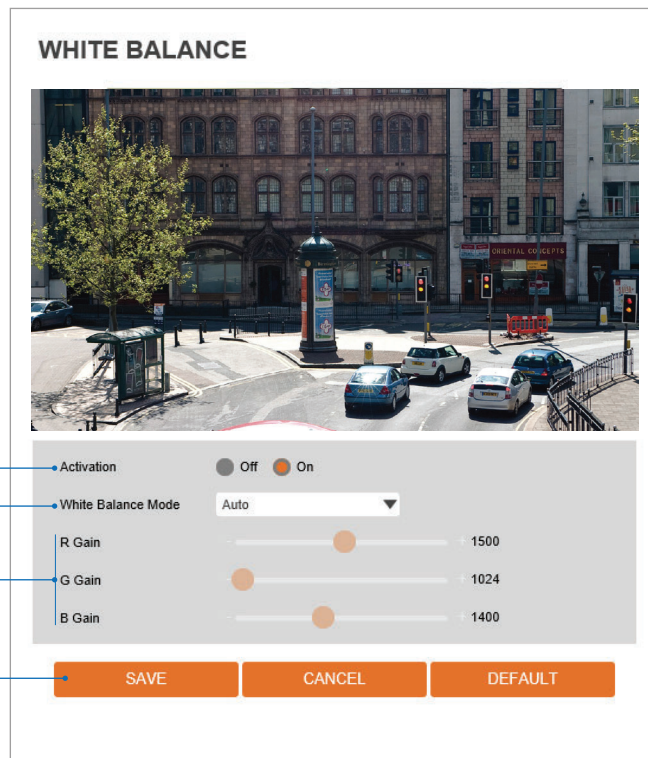

- 1 **Activation** - Enable or disable White Balance.
- 2 **White Balance mode** - Select the appropriate White Balance mode depending on the lighting conditions.
- 3 **RGB gain** - The R/G/B gain can be set only when the White Balance mode is set to manual.
- 4 Click 'Save' to save the current settings.
  - ⊠ Click 'Cancel' to return to the previous setting.
  - ⊠ Click 'Default' to settings to the factory defaults.

# Setup - Camera setup

## Image enhancement

---

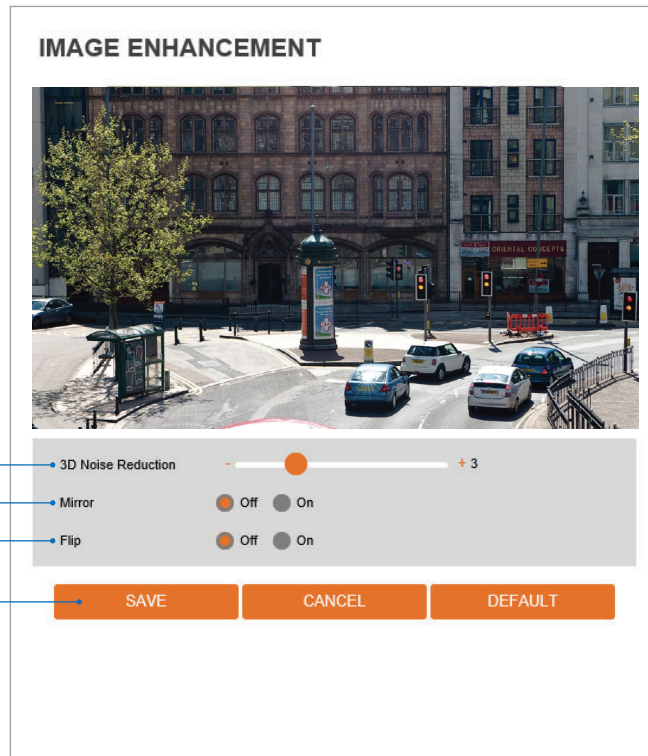

- 1 **3D Digital Noise Reduction** - 3DNR reduces digital noise while retaining good video quality in low light conditions.
- 2 **Mirror** - Reverse the video from side to side.
- 3 **Flip** - Reverse the video from up to down.
- 4 Click 'Save' to save the current settings.
  - ⊠ Click 'Cancel' to return to the previous setting.
  - ⊠ Click 'Default' to settings to the factory defaults.

# Setup - Camera setup

## Video enhancement

---

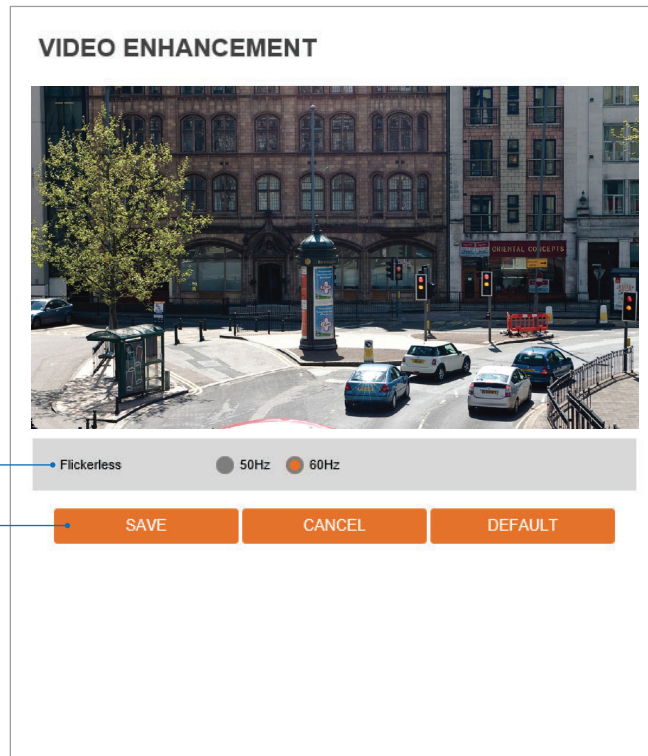

- 1 **Flicker** - Enable the flicker function to enhance the camera's image in case where flickering is seen.
- 2 Click 'Save' to save the current settings.
  - ⊠ Click 'Cancel' to return to the previous setting.
  - ⊠ Click 'Default' to settings to the factory defaults.

# Setup - Network setup

## Network status

---

NETWORK STATUS	
MAC Address	00:0D:F1:21:A1:45
IP Address	192.168.2.32
Subnet Mask	255.255.0.0
Default Gateway	192.168.1.1
Preferred DNS Server	210.220.163.82
Alternate DNS Server	219.250.36.130
HTTP Port	80
HTTPS Port	443
RTSP Port	554

This menu will show a summary of the camera's network settings and information. Settings cannot be changed from this screen.

# Setup - Network setup

## Network settings

---

The screenshot shows a 'NETWORK SETTINGS' configuration page. It is divided into three main sections: 'Network Type', 'IP setup', and 'Port Setup'.  
1. **Network Type**: Contains radio buttons for 'Static' and 'Dynamic'.  
2. **IP setup**: Contains input fields for 'IP Address' (192.168.1.30), 'Subnet Mask' (255.255.0.0), 'Default Gateway' (192.168.1.1), 'Preferred DNS Server' (210.220.163.82), and 'Alternate DNS Server' (219.250.36.130).  
3. **Port Setup**: Contains input fields for 'HTTP Port' (80), 'HTTPS Port' (443), and 'RTSP Port' (554). Each port field has a default value and a range in brackets: [ Default: 80, 1025 ~ 60000 ], [ Default: 443, 1025 ~ 60000 ], and [ Default: 554, 1025 ~ 60000 ].  
At the bottom right, there is an orange 'APPLY' button.

- 1 **Network type** - Set the camera's network type. Select Dynamic or Static IP.  
Static mode allows you to manually enter the camera's network information, including IP address, subnet mask, gateway, DNS Server and all ports.  
Dynamic mode allows the camera to get its network settings automatically from the network it is connected to.  
If you click the Apply button to update changes, the system will be re-booted.  
In this case, you have to reconnect the camera using new IP address.
- 2 **IP address** - Enter the camera's IP address. The address is consisted of four numbers separated by dots and the range of each number is from 0 to 255.
- 3 **Subnet mask** - Enter the subnet mask. Format is the same as the IP address.
- 4 **Default gateway** - Enter the gateway's IP address. Format is the same as the IP address.
- 5 **Preferred DNS server** - Enter the DNS server's IP address. Format is the same as the IP address.
- 6 **Alternate DNS server** - Enter the secondary DNS server's IP address, if needed. Format is same as the IP address.
- 7 **HTTP port** - The HTTP port can be set to 80 (default) or any value between 1025 to 60000.
- 8 **HTTPS port** - The HTTPS port can be set to 443 (default) or any value between 1025 to 60000.
- 9 **RTSP port** - The RTSP port can be set to 554 (default) or any value between 1025 to 60000.
- 10 Click 'Apply' to make above setting effective.

If the network type is dynamic, all the network settings will be changed automatically to match the settings of the current network. The IP address will change every time the camera power cycles, new firmware is installed, or the camera is reset to factory settings. In this case, you may need to search of your camera in the network again and re-add it to your server. Consult your network administrator for more information.

# Setup - Network setup

## Auto IP settings

---

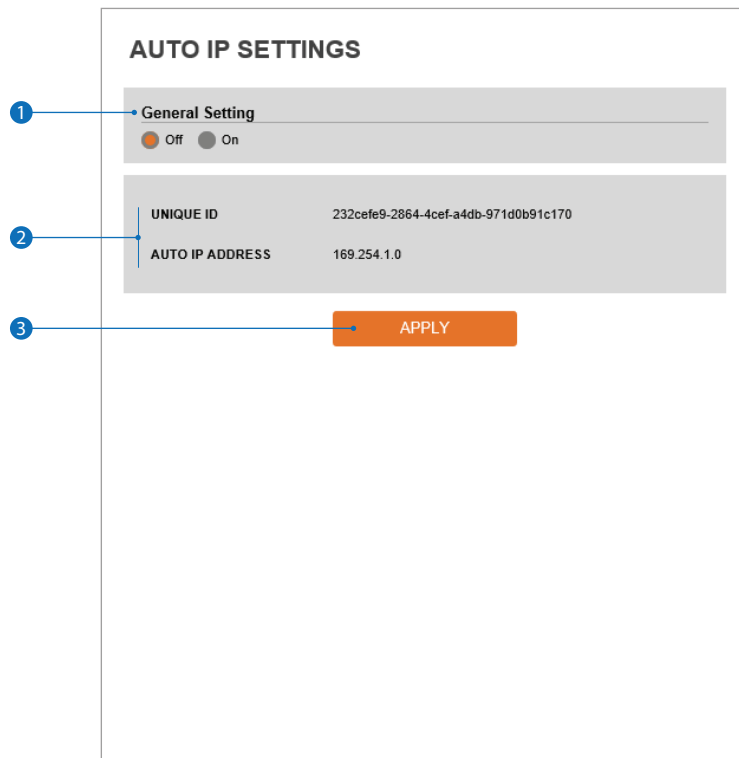

- 1 **General Setting** - Auto IP Settings function can be enable or disable.
- 2 **Auto IP Settings Information** - It displays the unique id or Auto IP address.
- 3 Click 'Apply' to make above setting effective.

# Setup - Network setup

## ONVIF settings

---

The screenshot shows the 'ONVIF SETTINGS' interface. It has two main sections: 'Authentication' and 'Discovery mode'. The 'Authentication' section has three radio buttons: 'None', 'WS-User token', and 'WS-User token + Digest'. The 'Discovery mode' section has two radio buttons: 'Discoverable' and 'Nondiscoverable'. Below these sections is an orange 'APPLY' button. Three numbered callouts (1, 2, and 3) point to the 'Authentication' section, the 'Discovery mode' section, and the 'APPLY' button respectively.

### 1 Authentication

**None:** Allows access to the camera without ONVIF authentication.

**WS - Usertoken:** Allows access to the camera with WS-User token of ONVIF authentication.

**WS - Usertoken + Digest:** Allows access to the camera with WS-User token and Digest of ONVIF authentication.

### 2 Discovery Mode - Enable or disable the camera to be discovered by any ONVIF devices on the network.

### 3 Click 'Apply' to make above setting effective.

# Setup - Network setup

## UPNP settings

---

**UPNP SETTINGS**

1 • General Setting  
 Off  On

2 • Device Information  
FriendlyName

3 • APPLY

- 1 **General setting** - UPNP function can be enable or disable.
- 2 **Friendly name** - Define the friendly name. Support a maximum of 30 characters and special character (/ ~ ! \$ ^ ( ) { } [ ] ; , ) can not be used. ('@', '.', '\_', '-', ' ') can be used.
- 3 Click 'Apply' to make above setting effective.



# Setup - Network setup

## DDNS settings

---

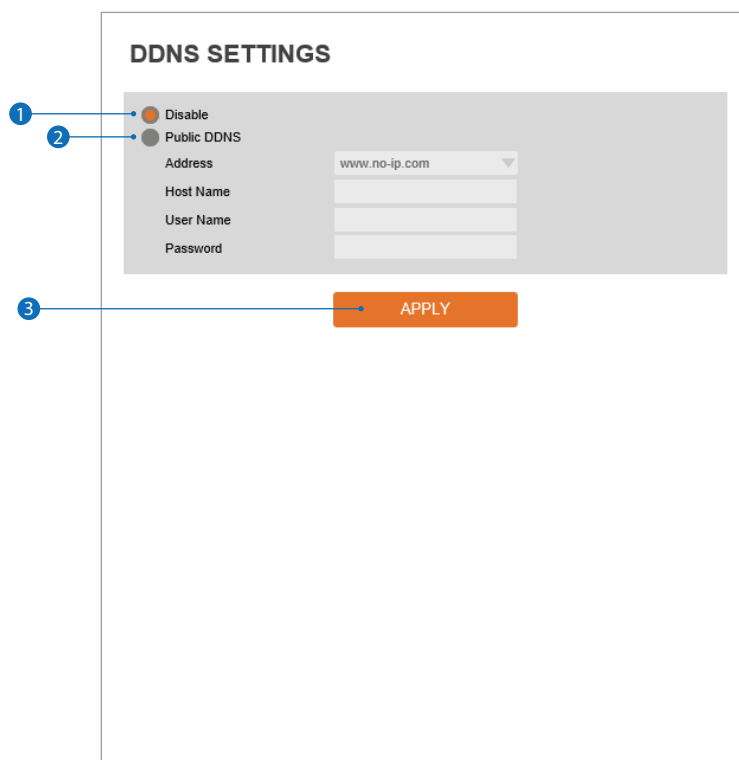

1 **DDNS disable** - If selected, DDNS service does not work.

2 **Public DDNS** - To use public DDNS service, select a site address listed in the list. After filling out the host name of the site, the setup is completed by entering user name and password registered on that DDNS site.

DDNS Provider	Site Address
DynDNS	www.dyndns.com
No-IP	www.no-ip.com

⚠ If you setup DDNS properly, the IP address of your camera will be updated automatically whenever IP address is changed or system is rebooted.

⚠ If IP updating to DDNS site is failed, the camera will keep retrying every 1 minute.

3 Click 'Apply' to make above setting effective.

# Setup - Network setup

## FTP settings

---

**FTP SETTINGS**

**General Setting**  
 Off  On

**Server information**

FTP Server Address

FTP Upload Path

FTP Port

User ID

Password

**APPLY**

To send and save images from the camera to an FTPserver, an FTP needs to be setup.

- 1 **General setting** - Enable or disable the FTP function.
- 2 **FTP server address** - Enter the FTP server's IP Address. If the IP address is incorrect, a message box will appear.
- 3 **FTP upload path** - Enter the path in the FTP server where the video from the camera will be stored. For the path name, English alphabets, numbers and special characters (/~!@\$^()\_ - {} [ ] ; , ) can be used.
- 4 **FTP port** - Enter the FTP server's port. If the port value is incorrect, the camera cannot access FTP server.
- 5 **User ID** - Enter User ID to access the FTP server.
- 6 **Password** - Enter the password to access the FTP server.
- 7 Click 'Apply' to make above setting effective.

☒ Refer the above screen image for the example.

# Setup - Network setup

## SMTP settings

---

The screenshot shows the 'SMTP SETTINGS' configuration page. It is divided into three main sections: 'General Setting', 'Account information', and 'Mail Contents'.  
1. 'General Setting' has a radio button for 'Off' (selected) and 'On'.  
2. 'Account information' has a radio button for 'PLAIN' (selected) and 'SSL/TLS'.  
3. 'Account information' includes text input fields for 'SMTP Server Address', 'PORT' (with '25' pre-filled), 'User ID', 'Password', 'E-Mail Sender', and 'E-Mail Receiver'.  
4. 'Mail Contents' includes a text input field for 'Title' and a larger text area for 'Message'.  
5. An orange 'APPLY' button is located at the bottom right of the form.

To send images from the camera to an E-mail account, SMTP needs to be setup.

- 1 **General setting** - Disable or enable the SMTP function.
- 2 **Mode** - Select security mode of SMTP from plain or SSL / TLS. After checking account setup of your SMTP server, you may select one.
- 3 **SMTP Server Address** - Define the SMTP server address. If the IP Address is incorrect, a message box will be shown.
- 4 **Port** - Define the port used in the Plain or SSL / TLS security mode in the above.
- 5 **User ID** - Define the User ID to access the SMTP server. Fill out the correct User ID registered in the SMTP server.
- 6 **Password** - Define the Password to access the SMTP server. Fill out the correct password registered in the SMTP server.
- 7 **E-Mail Sender** - Define the e-mail address of e-mail sender. It will be displayed as the sender when the camera sends an e-mail.
- 8 **E-Mail Receiver** - Define the e-mail address of e-mail receiver. It will be displayed as the receiver when the camera sends an e-mail
- 9 **Title** - Define the title of the e-mail when the camera sends an e-mail.  
⚠️The title of the e-mail is limited to 40 characters including the spaces.
- 10 **Message** - Define the contents of e-mail when camera sends an e-mail. The message of the e-mail is limited to 40 characters including the spaces.
- 11 Click 'Apply' to make above setting effective.

# Setup - Network setup

## SNMP settings

---

**SNMP SETTINGS**

**SNMP v1/v2c**

SNMPv1  Off  On

SNMPv2c  Off  On

Read Community

Write Community

SnmpTrap  Off  On

TrapAddress

TrapCommunity

**SNMP v3**

Mode

Activation  Off  On

Read Name

Security Level

Authentication Algorithm

Authentication Password

Private-Key Algorithm

Private-Key Password

**APPLY**

1 **SNMPv1/SNMPv2** - Select the SNMPv1/SNMPv2 option and type the names of read community and write community.

**SNMP trap can be used to check periodically for operational thresholds or failures that are defined in the MIB.**

2 **SNMP trap** - SNMP trap can be enabled or disabled.

**SNMPv3 contains cryptographic security, a higher security level, which allows you to set the Authentication password and the Encryption password.**

3 **Mode** - Select the either read or read/write mode.

4 **Activation** - Enable or disable the mode.

5 **Read/write name** - Define Read name and write name.

6 **Security level** - Select one of no auth, no priv/auth , no priv/auth, priv.

7 **Authentication algorithm** - Select MD5 or SHA as the authentication method.

8 **Authentication password** - The password is encrypted for authentication and must be at least 8 digits. Up to 30 digits are allowed.

9 **Private-key algorithm** - Select DES or AES as the encryption algorithm.

10 **Private-key password** - Information protection password is a private encryption and they are at least 8 digits and up to 30 digits allowed.

11 Click 'Apply' to make above setting effective.

# Setup - Network setup

## RTSP information

---

The screenshot shows the 'RTSP INFORMATION' configuration page. It is divided into several sections: 'RTSP Global Setting', 'Session Timeout', 'Rtp Multicast', and a table of connections. Five numbered callouts (1-5) point to specific elements: 1 points to the 'Target Stream' dropdown menu; 2 points to the 'Time Out' input field; 3 points to the 'MULTICAST' radio buttons and the 'IP', 'PORT', and 'TTL' input fields; 4 points to the orange 'APPLY' button; and 5 points to the table of RTSP connections.

No	Remote IP	Port	Type
1	192.168.1.31	54385	TCP
2	192.168.1.31	54388	TCP
3	192.168.1.88	62822	TCP

- 1 **Target Stream** - Select the stream you want to set.
- 2 **Time out** - Set the RTSP time out.
  - ⊠ The session is disconnected after the specified time out.
- 3 **RTP Multicast** - Check RTP Multicast On/Off. To activate RTP Multicast.
  1. Click "On" button.
  2. Enter accessible RTP Multicast IP, port for video stream control, RTP packet TTL.
  3. Click "Apply" button.
  - ⊠ It is possible to set each RTP Multicast for CH1~3.
- 4 Click 'Apply' to make above setting effective.
  - ⊠ Click this button when setup is completed for each channel.
- 5 It shows RTSP Connection information.

# Setup - Trigger action setup

## Action rules configuration

---

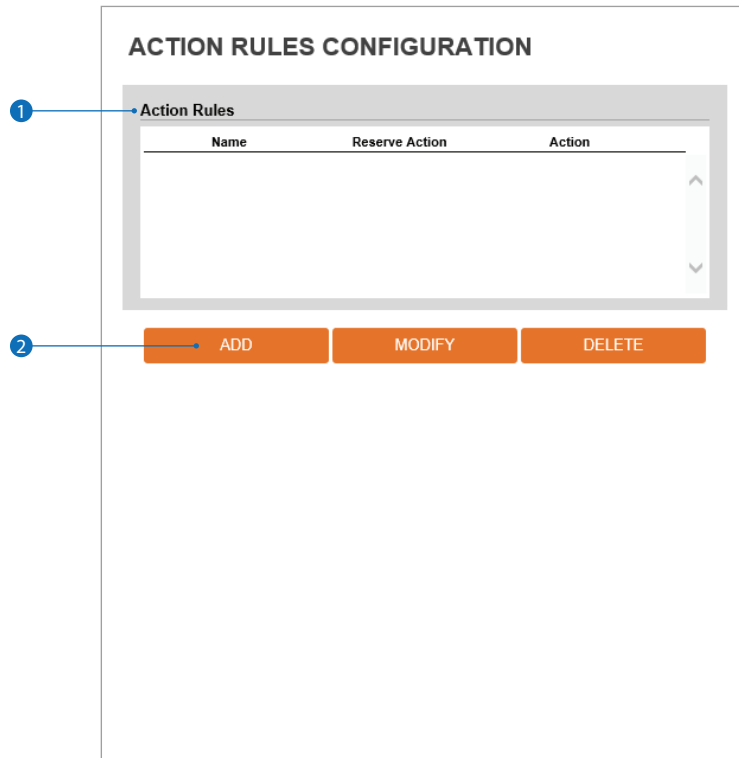

- 1 **Action rules list** - It indicates the custom action rule information added to action rules list.
- 2 Click 'Add' to add custom action rules.
  - Click 'Modify' to modify selected item from the action rules list.
  - Click 'Delete' to delete selected item from the action rules list.

# Setup - Trigger action setup

## Action rules add / modify

---

**ACTION RULES CONFIGURATION**

**General Setting**

1 Name

Action1

2 Action2

Action3

Action4

Action5

3

- 1 **Name** - Define name of action rules.
  - ⊠ Input text cannot exceed the limit (3~15).
- 2 **Action1 ~ Action5** - Select the action to take If the event occurs.
- 3 Click 'Save' to save the current settings.
  - ⊠ Click 'Cancel' to return to the previous menu.

# Setup - Trigger action setup

## Image transfer configuration

---

### IMAGE TRANSFER CONFIGURATION

1. Add the FTP/SMTP action in the event rules menu.  
2. When an event occurs, the images will be sent to ftp/smtp address .  
3. Determine the image transfer speed and the duration of image transfer after/before an event.

1 → Pre/Post Alarm Image

Number Of Image	<input type="text" value="2"/>	Image Per Seconds(s) [ 1 ~ 5 ]
Pre-Alarm Duration	<input type="text" value="3"/>	Second(s) [ 1 ~ 5 ]
Post-Alarm Duration	<input type="text" value="3"/>	Second(s) [ 1 ~ 30 ]

2 →

- 1 **Pre- / post- alarm image** - Image transfer due to event is configured by setting up the image transfer rate and pre and post alarm duration.

	Descriptions
Number of images	Define Number of images transferred per second.
Pre-alarm duration	Define duration of the image transfer before an event.
Post-alarm duration	Define duration of the image transfer after an event.

- 2 Click 'Apply' to make above setting effective.



# Setup - Event setup

## Event rules configuration

---

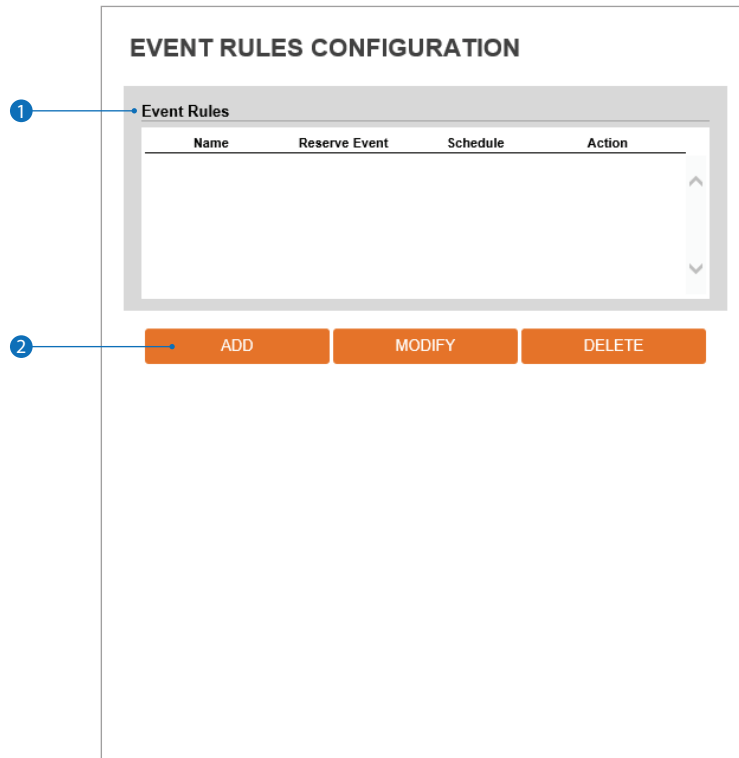

- 1 **Event rules list** - It indicates the custom event rule information added to event rules list.
- 2 Click 'Add' to add custom event rules.
  - ☒ Click 'Modify' to modify selected item from the event rules list.
  - ☒ Click 'Delete' to delete selected item from the event rules list.

# Setup - Event setup

## Event rules configuration

---

The screenshot shows a form titled "EVENT RULES CONFIGURATION" with three main sections: "General", "Event Condition", and "Action".

- 1** points to the "Name" input field in the "General" section, which contains the text "NewRule".
- 2** points to the "Event" dropdown menu in the "Event Condition" section, which is currently set to "NONE".
- 3** points to the "Rules" dropdown menu in the "Action" section, which is currently set to "NONE".
- 4** points to the "SAVE" and "CANCEL" buttons at the bottom of the form.

- 1 Name** - Define the event rule name.
- 2 Event** - Select an event type from motion detection, network disconnection, illegal login detected, temperature critical or sensor detection.
  - ⊠ Click 'Cancel' to return to the previous setting. You need one or more events.
- 3 Rules** - Select the action rule defined in the trigger action-action rule menu.
- 4** Click 'Save' to save the current settings.
  - ⊠ Click 'Cancel' to return to the previous setting.

# Setup - Event setup

## Motion detection configuration

---

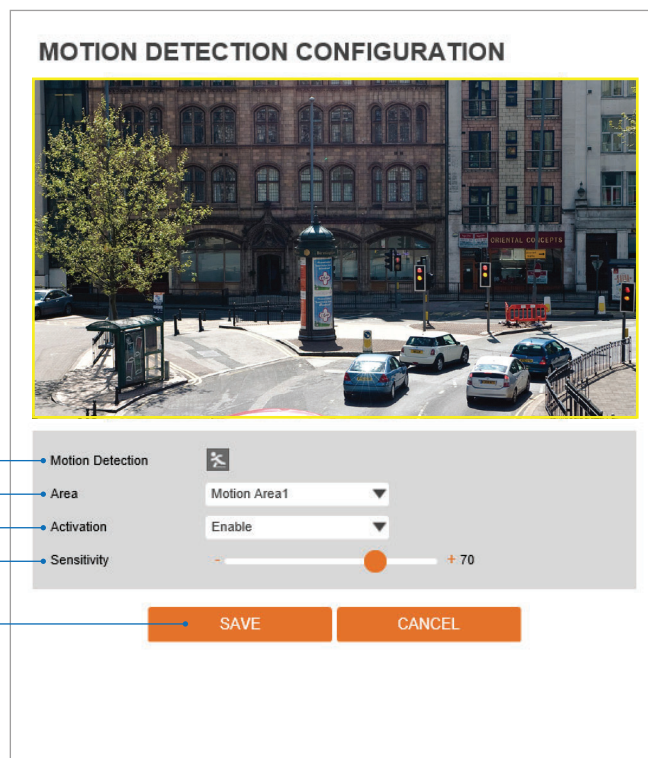

- 1 Motion Detection** - When the camera detects motion, it will show the motion detection icon in orange on the camera's view.
  - Event alert icon (  ) appears if 'motion detection' is activated.
- 2 Area** - Set the motion detected area. Select an area from the drop-down list. Using the mouse, click and drag to mark the size and position of the motion detection zone. You can setup 4 separate zones.
- 3 Activation** - Enable or disable motion detection function.
- 4 Sensitivity** - Define the sensitivity of motion detection.
  - If high is selected, the camera will detect very small motion. If low is selected, the camera will detect only large motion events in its view.
- 5** Click 'Save' to save the current settings.
  - Click 'Cancel' to return to the previous setting.

# Setup - Security setup

## IP address filter configuration

---

The screenshot shows the 'IP ADDRESS FILTER CONFIGURATION' interface. It is divided into two main sections: 'General Setting' and 'Filtered IP Address'. In the 'General Setting' section, there is a radio button for 'IP Address Filter' (currently set to 'Off'), a dropdown menu for 'IP Filter Type' (set to 'Allow'), and an orange 'APPLY' button. The 'Filtered IP Address' section contains a list box for displaying filtered IP addresses. Below this list is an input field for 'IP Address' with a placeholder '[ Invalid ]' and two orange buttons: 'ADD' and 'REMOVE'. Six numbered callouts (1-6) point to these specific elements: 1 points to the 'IP Address Filter' radio button, 2 to the 'IP Filter Type' dropdown, 3 to the 'APPLY' button, 4 to the 'Filtered IP Address' list box, 5 to the 'IP Address' input field, and 6 to the 'ADD' button.

- 1 **IP address filter** - Enable or disable IP filter function. If enabled, you can filter and prevent access to the IP camera from specific IP addresses.
- 2 **IP filter type** - Select the IP filter type.
- 3 Click 'Apply' to make above setting effective.
- 4 **Filter IP address** - Display the filtered IP address.
- 5 **IP address** - Define the IP address you want to apply the IP filter.
- 6 Click 'Add' to add the IP address to the list.
  - Click 'Remove' to remove the ip address selected in the list.

# Setup - Security setup

## RTSP authentication configuration

---

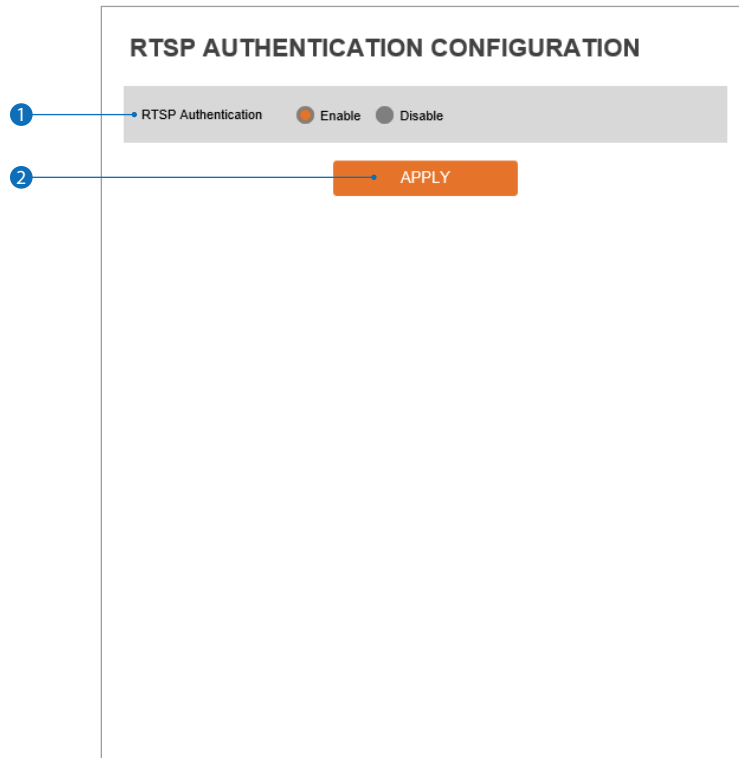

- 1 **RTSP authentication** - RTSP authentication can be enable or disable.
- 2 Click 'Apply' to make above setting effective.

# Setup - Security setup

## IEEE 802.1X configuration

---

**IEEE 802.1X CONFIGURATION**

**General Setting**

1 IEEE 802.1x  On  Off

2 Protocol MD5

3 EAPOL Version 1

4 ID

5 Password

6 Retype Password

7 CA Certificate NONE

8 Certificate NONE

9 APPLY

The feature is needed when connecting the camera to a network protected by the IEEE 802.1X.

- 1 IEEE 802.1x - The IEEE 802.1x feature can be enabled or disabled.
- 2 **Protocol**
  - MD5: It provides one-way password-based network authentication of the client.
  - PEAP: It is similar to TTLS in that it does not require a certificate on the client side.
  - TTLS / MD5: It does not require a certificate on the client side.
  - TLS: It relies on client-side and server-side certificates to perform authentication.
- 3 **EAPOL version** - Select the EAPOL Version.
- 4 **ID** - Type the ID to identify the client in the IEEE 802.1X authentication server.
- 5 **Password** - Type the password to identify the client in the IEEE 802.1X authentication server.
- 6 **Verify** - Verify password.
- 7 **CA certificate** - Select the CA certificate required for TLS, TTLS, and PEAP authentication.
- 8 **Certificate** - Select the client certificate required for TLS authentication
- 9 Click 'Apply' to make above setting effective.

# Setup - Security setup

## HTTPS configuration

---

The screenshot shows the 'HTTPS CONFIGURATION' interface. At the top, there is a note: '1. If no certificates are available go to certificates to manage.' Below this, there are two main sections: 'Certificates' and 'HTTPS connection Policy'. The 'Certificates' section has a 'Certificate' dropdown menu currently set to 'NONE', with a blue circle '1' pointing to it. The 'HTTPS connection Policy' section has three rows: 'Administrator', 'Operator', and 'Viewer', each with a dropdown menu set to 'HTTP and HTTPS', with a blue circle '2' pointing to the 'Operator' row. At the bottom of the configuration area is an orange 'APPLY' button, with a blue circle '3' pointing to it.

**HTTPS encrypts session data over SSL or TLS protocols instead of using plain text in socket communications.**

- 1 Certificate** - Select an installed certificate.
  - ⚠ If you cannot select a certificate, please install the certificate from the security > certificates menu.
- 2 HTTPS connection policy** - Select one of "HTTP", "HTTPS", "HTTP and HTTPS" depending on the connected user authority.
- 3** Click 'Apply' to make above setting effective.
  - ⚠ When HTTPS mode is chosen, input `https://<IP Address>` to connect to the camera.

# Setup - Security setup

## Certificates configuration

---

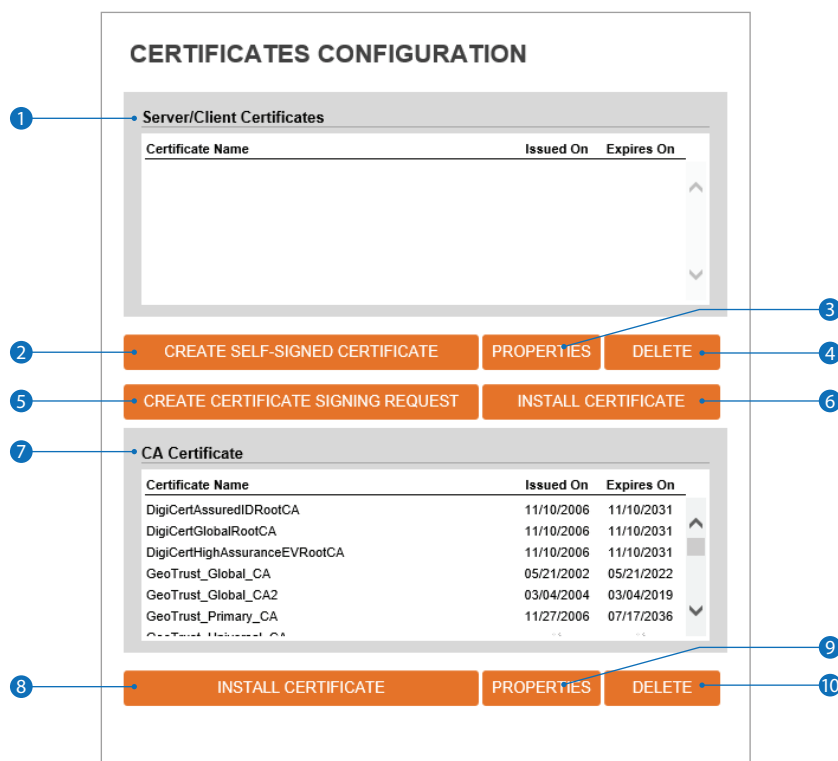

- 1 **Server/client certificates** - It show the installed certificates.
- 2 **Create self-signed certificate** - A self-signed SSL certificate is an identity certificate signed by its own creator. They are considered to be less trustworthy.
- 3 **Properties** - Shows information about the selected certificate.
- 4 **Delete** - Delete the selected certificate.
- 5 **Create certificate signing request** - This is the encoded data that contains the necessary information for issuing the certificate.  
⚠️ They must be filled in when creating the CSR (Certificate Signing Request).
- 6 **Install certificate** - Install certification
- 7 **CA certificate** - It show the installed CA certificates.
- 8 **Install CA certificate** - Install certification, see the detail page.
- 9 **Properties** - Shows information about the selected certificate.
- 10 **Delete** - Delete the selected CA certificate.



# Setup - Security setup

## Certificates configuration

---

### Detail for install certification.

- 1 **Certificate from signing request** - Select to install signed certificate returned from the CA.
- 2 **Certificate and private key** - Select Certificate And Private Key to install a certificate and private key.
- 3 **Certificate name** - Enter a unique name to identify certificate.
- 4 **Select file** - Choose certification file.
- 5 **OK** - Request installing certificate.
- 6 **Cancel** - Cancel install certificate and then back to certificates configuration.

### Detail for install CA certification.

- 7 **Certificate name** - Enter a unique name to identify CA certificate.
- 8 **Select file** - Choose CA certification file
- 9 **OK** Request installing CA certificate.
- 10 **Cancel** - Cancel install CA certificate and then back to certificates configuration.

# Setup - Security setup

## Service configuration

---

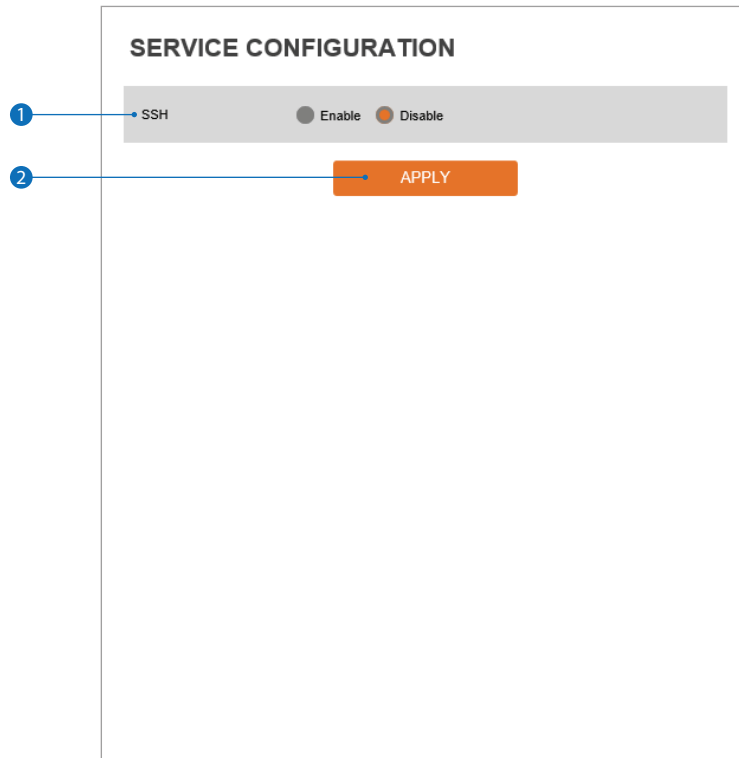

- 1 SSH - The SSH function can be enable or disable.
- 2 Click 'Apply' to make above setting effective.

# Setup - System setup

## System information

---

**SYSTEM INFORMATION**

1 Device Name IP-Camera

2 APPLY

Model Name	NCFx-SLAH2
Manufacturer	Digital Watchdog
Max Resolution	1080p
Max Framerate	30 fps
Photo Resistor(CDS)	SUPPORT
Alarm In	NOT SUPPORT
Relay out	NOT SUPPORT
Audio	NOT SUPPORT
Optical Zoom	NOT SUPPORT
Digital Zoom	NOT SUPPORT
PTZ	NOT SUPPORT

### System Capability information.

- 1 **Device Name** - You can define the device name.
- 2 Click 'Apply' to make above setting effective.

# Setup - System setup

## System diagnostics

---

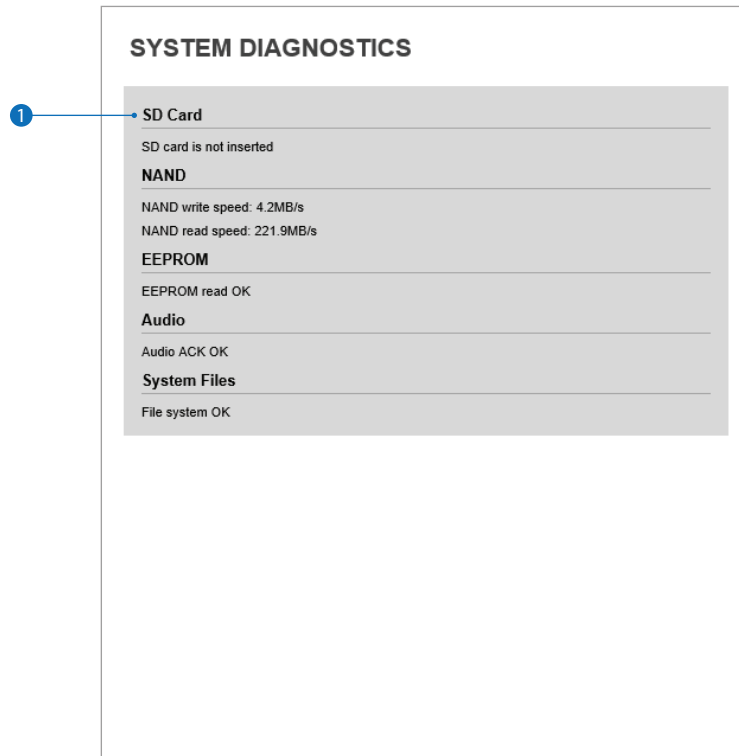

Shows basic hardware functions after inspection.

1 Shows SD card, NAND, EEPROM, Audio chip and important file system.

⚠ **Warning:**

If the camera is abnormally terminated, a download button will appear on the diagnostics page to download a file that allows you to check the error information you can.

If you want to download the core dump file , press the Download button

DOWNLOAD

# Setup - System setup

## Firmware update

---

**FIRMWARE UPDATE**

- Do not power off during update. It may cause fatal system damage.
- If Explorer was closed abnormally or a user closed accidentally while uploading firmware file, please try again after 30 seconds.
- Please do not select other menus while updating firmware file.

**1** **Version Information**

System	2018.08.09_A8.1.3
Camera	-

**2** **Web update**

Firmware File

**3**

**FTP user information**

FTP Server Address	<input type="text" value="ftp.dwcc.tv"/>
FTP Port	<input type="text" value="21"/>
User ID	<input type="text" value="dwmpix"/>
Password	<input type="password" value="*****"/>
FTP Upload Path	<input type="text" value="/"/>

**1 Version Information** - It shows the current Firmware Version in the system.

**2 Web Update** - Select the Firmware file in your computer by clicking [Select file] button.

**3 Start F / W Update** - Click this button to start update. Progress of uploading will be displayed using Progress Bar.  
If you assign the wrong file name, an error message will be shown.

**⚠ Warning:**

- Do not turn off the power of camera during the Firmware update. Otherwise, the system can be stuck to be unstable.  
If updating is finished, the system will be rebooted automatically.
- Please make sure to check the 'Notice' shown on screen.  
If firmware update is completed, the camera will reboot automatically and 'Setup window' will be closed.

# Setup - System setup

## Firmware update

- 4 **FTP Server Address** - Define FTP Server IP Address. If IP Address form is incorrect, a Message box will be shown to try again.
- 5 **FTP Port** - Define the FTP Server Port. If Port is not appropriate, it is impossible to access to FTP Server.
- 6 **User ID** - Define User ID to access to the FTP Server. Fill out the correct User ID registered in the FTP Server.
- 7 **Password** - Define Password to access to the FTP Server. Fill out the correct Password registered in the FTP Server.
- 8 **FTP Upload Path** - Define a path in FTP server to store video. For the path name, English Alphabets, numbers and special characters (/ ~ ! @ \$ ^ ( ) \_ - { } [ ] ; , ) can be used.
- 9 Click 'Save' to make above setting effective.

SAVE	Save FTP information
CANCEL	Click 'Cancel' to return to the previous setting.
CHECK	Check the F/W file and if the file exists, 'F/W Update' button will appear and click it to update for F/W.

# Setup - System setup

## Date and time settings

---

The screenshot shows the 'DATE&TIME SETTINGS' interface. It is divided into three main sections: 'TimeZone Setup', 'Time Format', and 'Current Date & Time'.  
1. 'TimeZone Setup' includes a 'TimeZone' dropdown menu set to '(GMT-08) Pacific Time (US & Canada), Baja California' and an 'APPLY' button.  
2. 'Time Format' includes a 'Time Format' dropdown menu set to 'mm/dd/yy' and an 'APPLY' button.  
3. 'Current Date & Time' shows the current date and time as '05/21/2019 17:45:50'. Below this is the 'New Camera Date & Time' section with three radio button options:  
4. 'Synchronize with my computer' (unselected), with a 'Date & Time' field showing '05/22/2019 09:45:51'.  
5. 'Setup manually' (unselected), with 'Date' fields for year (2005), month (01), and day (01), and 'Time' fields for hour (00), minute (00), and second (00).  
6. 'Synchronize with time server (NTP)' (selected), with an 'NTP Server' dropdown menu set to 'pool.ntp.org'.  
7. A final 'APPLY' button at the bottom of the section.

- 1 Time zone setup - Choose a timezone for the camera. The camera is set by default to PST. Click 'Apply' to make the change effective.
  - ⚠ The timezone must be setup before adjusting the camera's date and time.
- 2 Time format - Select the time display format from yy-mm-dd or mm/dd/yy.
- 3 Current date and time - This section shows the camera's current date and time.
- 4 Synchronize with my computer - You can select to synchronize the camera's date and time with the computer you are currently using to access the camera.
- 5 Setup manually - If selected, enter the date and time you wish to setup for the camera.
- 6 Synchronize with time sever time zone (NTP) - If selected, choose a time server from the drop-down list to connect to the camera. The camera's date and time will be updated automatically every hour based on the selected NTP.
- 7 Click 'Apply' to save all changes.

# Setup - System setup

## DST settings

---

The screenshot shows a web interface for configuring Daylight Saving Time (DST) settings. The interface is titled "DST SETTINGS" and is divided into two main sections: "General Setting" and "Date&Time Settings".

- 1** points to the "General Setting" section, which contains a radio button interface with "Off" selected and "On" unselected.
- 2** points to the "Date&Time Settings" section, which contains two rows of dropdown menus:
  - Start Time:** Mar, Second, Sun, 2, o'clock
  - End Time:** Nov, First, Sun, 2, o'clock
- 3** points to an orange "APPLY" button located at the bottom of the settings area.

**Daylight Saving Time (DST) is the practice of setting the clocks forward one hour from standard time during the summer months, and back again in the fall, in order to make better use of natural daylight.**

- 1 General setting** - DST function can be enabled or disabled.
- 2 Date and time settings** - Set the start time and end time when the DST settings will be enabled.
- 3** Click 'Apply' to make above setting effective.



# Setup - System setup

## Users management

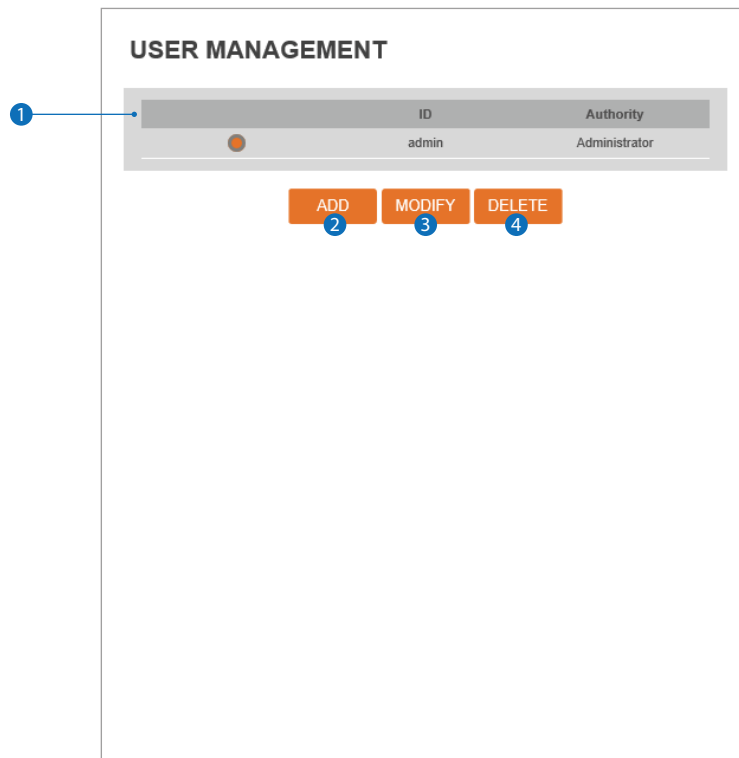

1 **Users** - List all the user accounts for authentication.

2 **Add** - Register a new user.

ID:   
 Password:   
 Retype Password:    
 Password Hint:   
 User Authority:

Password requirement : minimum 8 characters with at least three combinations of uppercase letters, lowercase letters, numbers and special characters.  
 Acceptable special characters are: ~ ! \$ ^ ( ) \_ - { } [ ] ; . ? /

ID	Enter a new user ID except Admin.
Password	Enter the user password. (Check the Password)
Retype password	Enter the user password again for verification.
Password hint	Enter the password hint.
User authority	Select operator or viewer for the user's permission level. Viewer: Allowed to view live video only. Operator: Allowed access to most of the camera's functions, live and playback video.

⚠ The ID and password are limited to 8 characters with at least two combinations of uppercase letters, lowercase letters, numbers and special characters. Acceptable special characters are : ~ ! \$ ^ ( ) \_ - { } [ ] ; . ? /

Click 'Apply' to make above setting effective.

⚠ Click 'Cancel' to return to the previous menu.

3 **Modify** - Modify the information of the user accounts registered. For the Admin account, only the password can be modified.

4 **Delete** - Delete the selected user account. Admin account cannot be deleted.

# Setup - System setup

## System log

---

**SYSTEM LOG**

**1 Filter**

Date 09/11/2018 ~ 09/11/2018

Time 0 0 0 ~ 0 0 0

Type All

Sort Ascending

**2 REFRESH** **FILTER**

**3 List**

Date & Time	Log	IP
09/11/2018 15:00:29	RTSP session connected	192.168.1.88
09/11/2018 14:53:49	Motion detected : 1 : Off	system
09/11/2018 14:53:46	Motion detected : 1 : On	system
09/11/2018 14:49:45	Motion detected : 1 : Off	system
09/11/2018 14:49:42	Motion detected : 1 : On	system
09/11/2018 14:44:35	Motion detected : 1 : Off	system
09/11/2018 14:44:32	Motion detected : 1 : On	system
09/11/2018 14:38:44	Motion detected : 1 : Off	system
09/11/2018 14:38:41	Motion detected : 1 : On	system

Navigation: << < 1 2 3 4 5 6 7 8 9 10 > >>

**1 Filter** - Select a date, time, sort or type of log to filter the log.

**2** Click the 'refresh' button to refresh the log list.

☒ Click 'filter' to view the filtered log.

**3 System log list** - The filtered log is displayed.

# Setup - System setup

## Factory reset

---

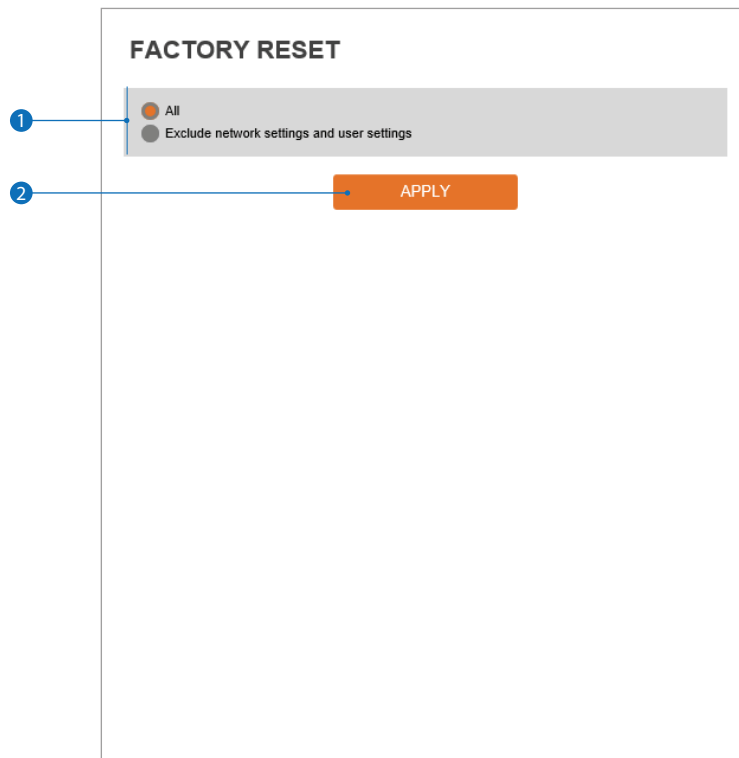

- 1 **Reset to the factory defaults** - Return the setup to the factory default.

.....  
**All** - Reset all Settings to the factory defaults.

**Except network settings and user settings** - Reset the camera to its default settings except for the network and user related settings.

- 2 Click 'Apply' to make above setting effective.

## Setup - System setup

# Restart

---

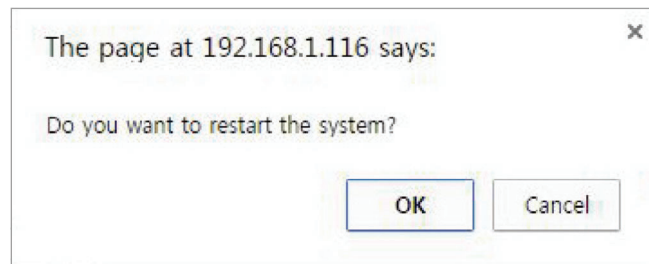

If you click the 'RESTART' menu, a message box will be shown to confirm. Click the 'OK' button to restart.

## Setup - System setup

# System open source license

---

Open Source Name	Version	License
busybox	1.24.1	GPLv2
alsa-lib	1.1.2	GPLv2.1
libglib2	2.47.1	LGPLv2
libnutls	3.4.11	LGPLv2.1
libjson-c	0.11-20140402	JSON License
libcurl	7.50.1	MIT/X derivate License
libffi	3.1	MIT License
libcrypt	1.6.1	LGPLv2.1
libnl	3.2.24	LGPLv2.1
libogg	1.3.1	BSD-style License
libsamplerate	0.1.8	GPLv2
libselinux	2.3	Public domain
libsndfile	1.0.25	LGPLv2.1
libssh2	1.6.0	BSD
libtasn1	4.8	GPLv3

This menu shows all system open source licenses in the camera. The data shows the open source's name, version and license information.

# Appendix

## Quick start of network connection

---

### Please follow the steps below to complete the initial setup of the network function.

- i** Please do not power on the IP Camera until instructed.
- i** Temporarily disable any proxy servers configured in internet Explorer.
- i** If connecting the IP Camera directly to a modem, power down and reset the modem. Leave the modem powered down until configurations are finalized with the IP Camera and the IP Camera has been correctly connected to the modem.

1 Connect the IP Camera and PC to the configured network.

2 Open the IP Installer on a PC, then search for the IP camera.

- i** If you have a DHCP server, it will automatically set the Camera IP.
- i** If you do not have a DHCP server, Camera IP is set to 192.168.1.80 after one minute. In this case, PC IP must be changed to the IP to be able to access the 192.168.1.80.

3 If multiple numbers of camera are connected it should be distinguished by the mac address of the Camera.

4 Click the Camera IP, and connect to the WEB PAGE.

5 Default ID/Password to access IP Camera are both the word: admin.

6 Familiarize yourself with the Viewer Interface Screen.

7 Please install VLC to display live video.

8 The IP setting can be set to 'STATIC' at IP Installer or web viewer followed by Setup -> Network -> Network Settings

9 If the IP Camera is connected to a network which utilizes a router, you must have Port Forwarding configured on your personal router to forward all ports to the IP address you have assigned the IP Camera.

10 After configuring Port Forwarding on your router (if necessary), you may access your IP Camera on your local network by opening Internet Explorer and specifying the IP address and Web Port that you have assigned to the IP Camera.

- i** Example: <http://192.168.0.200:8888>
- i** If you leave your Web Port set to 80, you don't need to specify the port in the Address Bar to access to your IP Camera.

11 Access your IP Camera via the Internet :

---

If you use a static IP address assigned by your ISP

- 1) Open Internet Explorer.
  - 2) Type the IP of the IP Camera.
  - 3) If you use a router, type the routers' static IP and the web port number of the IP Camera.
- 

If you have a dynamic address provided by your ISP

- 1) Open Internet Explorer and visit the DDNS website.
  - 2) Register the IP Camera.
  - 3) Reboot the IP Camera.
  - 4) Give the DDNS server 10 minutes to locate your IP Camera's IP information.
  - 5) Click the refresh button in the Internet Explore.
  - 6) After your camera is connected, select your camera.
-

# Appendix

## Network set up DDNS registration

---

**If you have DYNAMIC IP service from your Internet Service Provider (ISP), you can't tell the current IP address of the IP Camera. To solve this problem, you have to register to our DDNS service.**

**At first, you have to check if you are using dynamic addressing. If so, register your IP Video Server on our DDNS website before you configure, setup, or install the IP Camera.**

**Even though your IP is not dynamic, you will get benefit if you register to DDNS. In this case, just remember 'hostname.dyndns.com/gate1' instead of complicated series of numbers like <http://201.23.4.76:8078>.**

**For more details, contact our Support Center.**

☒ To use a public DDNS called 'dyndns' or 'no-ip', refer to the detail information on how to use the service. (Visit the web site : <http://www.dyndns.com> or <http://www.no-ip.com>)

# Appendix

## Guide to network environment

---

**Please configure the IP Camera at the installation site. You must determine your network scenario in order to configure the IP Camera with the proper TCP/IP settings. This tutorial will guide you through the process. Before actually configuring the IP Camera, determine settings to be applied. Record those settings to be used to configure your IP Camera for reference.**

**When configuring your IP Camera, treat the IP Camera as another PC on your network. You will assign it several addresses and other TCP/IP properties to match your current network.**

**This step-by-step tutorial will teach what IP addresses and network configurations should be assigned based on the network scenario.**

- 1 Before you begin, locate any information and settings received from your Internet Service Provider (ISP). You may need to refer to these IP addresses at a later time during the configuration.

Current TCP/IP Settings	
IP Address	
Subnet Mask	
Default Gateway	
Primary DNS Server	
Secondary DNS Server (Option)	

Static  Dynamic

- 1 If you were not given any IP addresses or the ISP was responsible for the setup and installation of your Internet connection, go to step 2.
- 1 If you are not using a router on your network, your 'Current TCP/IP Settings' (from the previous section) and 'Assigned IP Addresses from My ISP' will be exactly the same.

- 2 You must determine whether the IP address is STATIC or DYNAMIC. At this moment, you are only concerned about the ISP. Did they provide you with a STATIC or DYNAMIC address? If you are unsure, contact your ISP.
- 3 Configure your IP Camera's TCP/IP settings for network connectivity by selecting Setup from the main interface and selecting TCP/IP located on the left of the Setup screen.

- 4 If prompted for ID and Password, use 'admin' for both entries. The default web port number is 80. If port 80 is blocked by the ISP, a value between 1025 ~ 60000 should be used. If TCP port 80 is blocked, consult the ISP.
- 5 The following descriptions are several basic network scenarios. Determine which scenario describes your network. If your network does not match one of the scenarios below and you are unsure how to setup your IP Camera, contact your network administrator and then call our Support Center.

1 You cannot control the rectangular gray areas and only the ISP has access to the devices.



# Appendix

## Network set up case A, B

### Case A: Dynamic IP + Personal Router [Most SOHO]

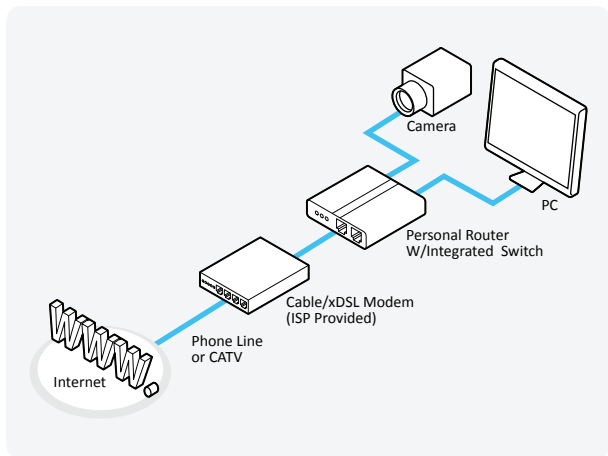

### Case B: Static(Fixed) IP + Personal Router [Efficient]

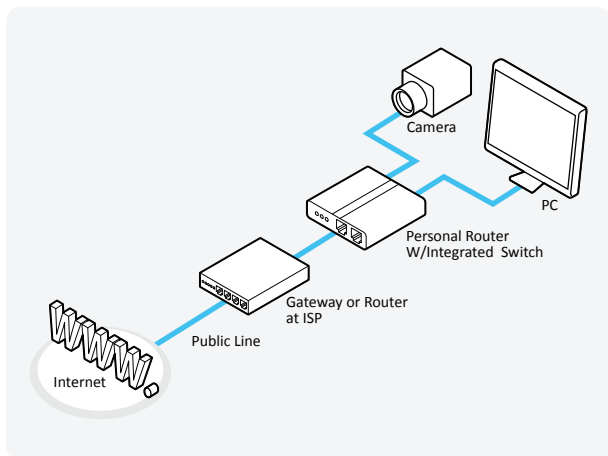

### Configure your IP Camera's TCP/IP properties as follows:

1 Network Type: STATIC (even though you have Dynamic IP from your ISP, use STATIC on the IP Camera)

2 Internet Address: A private IP address such as 192.168.0.200 (Example)

1 You need to assign an IP address to the IP Camera just as you do with PC.

1 The IP address you assign must be unique to your network and match your network as well. For information on how to choose a unique IP and match your network, read the FAQ.

1 The IP address you assign must be a private IP. For information on how to choose a private IP please, read the FAQ.

3 Subnet Mask: 255.255.255.0 (Example)

1 You must use the same subnet mask as the one you noted under 'Current TCP/IP Settings'.

4 Default Gateway: 192.168.0.1 (Example)

1 This IP address must be the IP address of your router. (private or LAN side)

1 Use the same Default Gateway you noted under 'Current TCP/IP Settings'.

5 Preferred DNS Server: Use the 1st DNS Server from 'Assigned IP Address from My ISP'.

1 If you did not receive any IP addresses from your ISP, contact the ISP and acquire the IP address of their DNS server.

6 DDNS Server: Use the DDNS server.

1 This is the same site you will register later to accommodate dynamic IP from your ISP.

7 Web Port: 8888

1 Do not use the default port 80 as this number must be changed.

1 You may select any number between 1025 ~ 60000.

# Appendix

## Network set up case C, D

### Case C: Static(Fixed) IP [Dedicated line directly to the IP Camera]

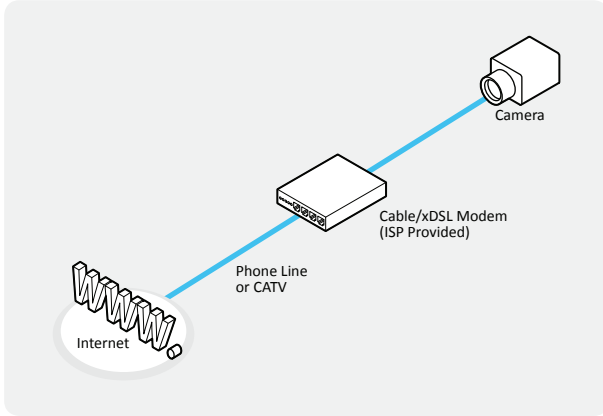

### Configure your IP Camera's TCP/IP properties as follows:

- 1 Network Type: STATIC
- 2 Internet Address: A static IP address received from your ISP such as 24.107.88.125 (Example)
  - i** You need to assign an IP address to the IP Camera just as you do with PC.
- 3 Subnet Mask: Subnet mask assigned from your ISP such as 255.255.255.240 (Example)
- 4 Default Gateway: 24.107.88.113 (Example)
  - i** Use the assigned default gateway from your ISP.
- 5 Preferred DNS Server: Use the 1st DNS Server from 'Assigned IP Address from My ISP'
  - i** If you have not received any IP addresses from your ISP, contact them to acquire the IP address of their DNS server.
- 6 DDNS Server: Use the DDNS server
  - i** This is the same site you will register later to utilize our DDNS service.
- 7 Web Port: 80
  - i** You may select any number between 1025 ~ 60000.

### Case D: Dynamic IP + DSL/Cable Modem [Connected directly to the IP Camera]

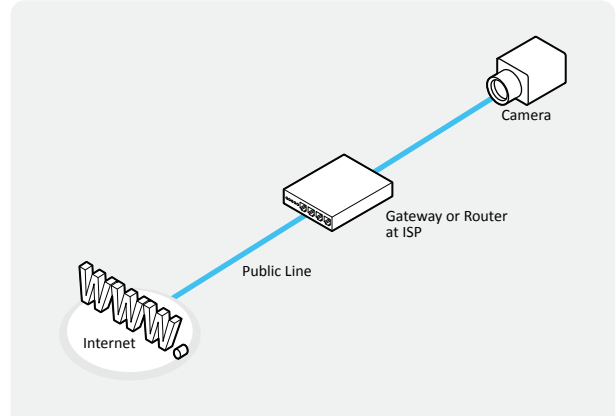

- i** To connect the IP Camera directly to a modem, power down and reset the modem. Leave the modem powered down until configurations are finalized with the IP Camera and the IP Camera has been connected correctly to the modem. Then power on the modem, followed by the IP Camera.

### Configure your IP Camera's TCP/IP properties as follows:

- 1 Network Type DYNAMIC
- 2 DDNS Server: Use the DDNS server
  - i** This is the same site you will register later to accommodate dynamic IP from your ISP.
- 3 Web Port: 80
  - i** You may select any number between 1025 ~ 60000.

# Appendix

## Port forwarding

---

**After entering the correct TCP/IP settings, you are ready for 'Port Forwarding' (Cases A, B).**

- 1 Please record the TCP/IP settings of your IP Camera for future reference. You may need this information to access your IP Camera and to configure 'Port Forwarding'.

IP Camera TCP/IP Settings	
IP Address	
Subnet Mask	
Default Gateway	
Preferred DNS Server	
DDNS Server	
Web Port	

- 2 After clicking 'Apply', the system will prompt for reboot. Please allow the system 50 seconds to reboot and accept the changes. After 50 seconds, close the configuration screen.  
The view will display 'Trying to Reconnect'. If the ACTIVE light on the IP Camera has gone off and is now back on again flashing, the IP Camera has rebooted. After the system reboots completely, remove the power supply from the unit and close Internet Explorer.
- 3 Return your PC/Laptop TCP/IP properties to their original settings.
- 4 Before installing the IP Camera, you must use 'Port Forwarding' on your personal router (Cases A, B). You will need to forward 1 port:
  - Web PortAll the ports will be forwarded to the IP address you assigned to the IP Camera.  
In the example above, you would forward:
  - 8888 > 192.168.0.200

- i** For information on how to use 'Port Forwarding', please read Appendix C.

# Appendix

## Starting the IP camera

---

### After forwarding correctly the Web Port, through your router (if applicable), install the IP Camera in a proper location.

- 1 Locate the serial number located on the label attached to the bottom of the IP Camera, you will need this for DDNS registration.
- 2 Connect the IP Camera to your router or cable/DSL modem (per your network scenario) via a Cat5/5e UTP Ethernet network cable.
- 3 Supply power to the IP Camera.
- 4 After 1 minute, verify the IP Camera indicators:
  - LINK : Flickering/Solid
- 5 After configuring Port Forwarding on your computer (if necessary), access your IP Camera on your local network by opening Internet Explorer and specifying the IP address and Web Port assigned to the IP Camera.

- i Examples: <http://192.168.0.200:8888> or <http://24.106.88.123>
- i If you left your Web Port set to 80, do not need to specify the port in the Address Bar to access the IP Camera.

- 6 Access your IP Camera via the Internet :

---

If you use Case B, C

- 1) Open Internet Explorer.
- 2) Type the IP of the IP Camera.

---

If you use Case A, D

- 1) Open Internet Explorer.
- 2) Visit the DDNS website.
- 3) Register the IP Camera.
- 4) Give the DDNS server 10 minutes (MAX) to locate your IP Camera's IP information. You may reboot the server to send an immediate request to our DDNS server.
- 5) After your camera is connected, select your camera.

- i The difference between B and C is that B needs to set the port forwarding.
- i Since the type of DDNS differs from the service type, refer to the related service site.

# Appendix

## FAQ

---

### 1. My POWER light is not on?

Power is not being supplied to the unit. Please use the power supply shipped with the unit and verify that a power source is active from the attached power outlet used to connect the adapter. You can test this by plugging in any other electrical device and verify its operation. After using the power supply shipped with the product, checking the power source, and reinserting the power connector into the IP Camera, please call our Support Center.  
The power supply may be defective.

### 2. My ACTIVE light is not flashing?

Verify power is being supplied to the unit. Power off the unit and back on again, wait 1 minute, if the ACTIVE light still does not begin to flash, you will have to set the unit to its factory default (THIS WILL DELETE ANY CONFIGURATION AND SET THE UNIT TO THE FACTORY DEFAULTS).  
Power on the unit and insert the end of a paper clip into the small recessed opening on the back of the unit. Use the clip to press the button located within that opening.

### 3. My LINK light is not flashing or solid?

Verify the cable connection. 99% of the time the cable's connection to the unit is causing this problem. Try using a different network cable or crossover cable (for PC connection only). Try reinserting the cable, if this still doesn't solve the problem call our Support Center.

### 4. I can access the video server on my LAN, but not from the Internet.

Verify that your router (if applicable) has port forwarding properly configured. If accessing from our DDNS service, verify correct serial number. Firewall issues may prevent user access.

### 5. How do I open an MS-DOS or Command Prompt?

Start > (All) Programs > Accessories > Command Prompt

### 6. How do I find out my IP address information if my settings were automatically detected?

- 1) Open a Command Prompt
- 2) At the prompt type - "ipconfig / all" (without the quotes)
- 3) Near the end of the information supplied, should be your current IP address, subnet mask, default gateway and DNS servers

### 7. I can't connect!!

In the case of a connection failure.  
Modem Reboot > Modem Reboot Finished > Router Reboot > Router Reboot Finished > IP Camera Reboot > IP Camera Reboot Finish > Verify DDNS and IP Camera connection, if applicable.

### 8. How do I "PING" an IP address?

- 1) Open an MS-DOS (or Command) prompt
- 2) At the prompt type - "ping xxx.xxx.xxx.xxx" (without the quotes and replace the "x" s with an IP address)
- 3) Press Enter

### 9. I'm accessing my video server remotely over the Internet and the video stream is choppy, is this normal?

Yes. The frames per second received remotely are determined by your bandwidth capabilities both at your site where the IP Camera is installed and your remote location. The lower of the two sites will determine how fast your video stream is received. It is recommended to have at least a 256Kb/sec upstream connection from the site where the IP Camera is installed. Lower speeds will operate properly, but provide poor remote performance. The faster the Internet connection at both ends, the faster the video stream.

### 10. How do I enable or check VLC on my browser?

---

Internet Explorer

Open Internet Explorer > Tools on the menu bar > Internet Options > Security Tab > Custom Level > Scroll down and verify that you are prompted or have enabled plug-ins to be downloaded and executed. > click OK > restart browser.

---

Chrome

Open Chrome > Chrome menu settings > Advanced settings > Individual information - content settings > Run automatically

---

### 11. How do I reset the unit to factory defaults?

Refer to the previous functions page and find the reset button. Power ON the unit and use a paper clip to push the reset button within that opening. You should then see the ACTIVE light turn off and after a few seconds the ACTIVE light will begin to flash, signifying a successful reboot. If the ACTIVE light does not turn off after depressing the reset button, please try holding the button in for a few seconds and releasing. YOU WILL LOSE ALL DATA THAT HAD BEEN ENTERED PREVIOUSLY AND THE IP CAMERA WILL BE SET TO ITS FACTORY RESETS.

# Appendix Dimensions

---

Unit: inch (mm)

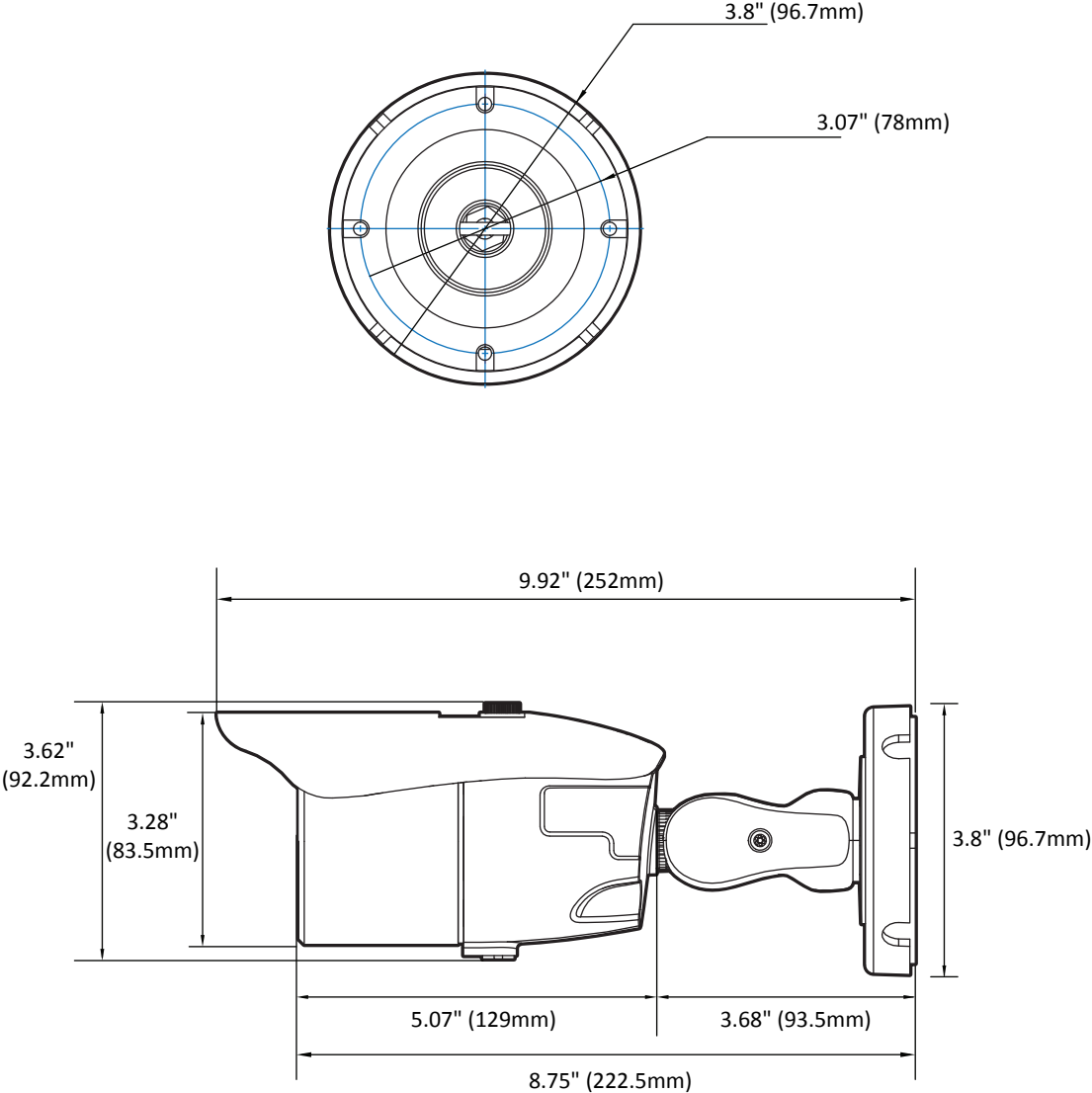

# Specification

CAMERA	
Image sensor	1/2.9" 2.1MP/1080p CMOS
Total pixels	2001(H) X 1121(V)
Focal length	2.7 ~ 13.5mm, F1.6, manual-IRIS
Field angle	D:31°~102.5°, H:27°~89.6°, V:15.2°~49.9°
Shutter speed	Auto, manual (1/15 ~ 1/32000), anti-flicker, slow shutter (off, 2X, 3X, 5X, 6X, 7.5X, 10X)
MIN. illumination	0.16 lux, 0 lux with IR (F1.6)
IR	H2IR, 75ft
WDR	D-WDR
Day and night	TDN (True day and night)
DNR	3D-DNR
Privacy zones	16 programmable zones
AGC	Auto
Other image processing	Exposure, white balance, sharpness, brightness, contrast, saturation, hue

ENCODER (VIDEO AND AUDIO)	
Video compression	H.265, H.264, MJPEG
H.265 profile	MP
H.264 profile	MP/HP
Multiple profile streaming performance	1080p30 + CIF(352x288 or 352x240) p30 with H.264, H.265 + MJPEG
Video bitrate	100kbps~10Mbps, multi-rate for preview and recording
Bitrate control	Multi streaming CBR/VBR at H.264, H.265 (controllable frame rate and bandwidth)
Edge storage	N/A

I/O AND EVENT	
Audio in/out	N/A
Alarm in/out	N/A
Video output (2nd video out)	N/A
Event notification	FTP, E-mail

SECURITY AND NETWORK	
Network protocol	IPv4 : TCP/IP / UDP / AutoIP / RTP(UDP/TCP) / RTSP / NTP / HTTP / HTTPS / SSL / DNS / DDNS / DHCP / FTP / SMTP / ICMP / SNMPv1/v2/v3(MIB-2) / ONVIF
Security	HTTPS (SSL), IP filtering, 802.1x, Digest Authentication
Programming I/F	CGI API, ONVIF

GENERAL	
Support languages	English
Power	(Adaptor is not Included) DC12V: max 5.2W POE IEEE 802.3af Class3: max 7W
Temperature	-4°F ~ 122°F (-20°C ~ 50°C)
Material	Aluminum die-casting
Dimensions (DxH)	9.92" x 3.8" (252 x 96.7 mm)
Weight	1.65 lb (0.75kg)
Certification	FCC, CE, ROHS, IP66

# Warranty Information

---

**Digital Watchdog** (referred to as “the Warrantor”) warrants the Camera against defects in materials or workmanships as follows:

**Labor:** For the initial five (5) years from the date of original purchase if the camera is determined to be defective, the Warrantor will repair or replace the unit with new or refurbished product at its option, at no charge.

**Parts:** In addition, the Warrantor will supply replacement parts for the initial two (2) years.

To obtain warranty or out of warranty service, please contact a technical support representative at 1+ (866) 446-3595, Monday through Friday from 9:00AM to 8:00PM EST.

A purchase receipt or other proof of the date of the original purchase is required before warranty service is rendered. This warranty only covers failures due to defects in materials and workmanship which arise during normal use. This warranty does not cover damages which occurs in shipment or failures which are caused by products not supplied by the Warrantor or failures which result from accident, misuse, abuse, neglect, mishandling, misapplication, alteration, modification, faulty installation, setup adjustments, improper antenna, inadequate signal pickup, maladjustments of consumer controls, improper operation, power line surge, improper voltage supply, lightning damage, rental use of the product or service by anyone other than an authorized repair facility or damage that is attributable to acts of God.



# Limits & Exclusions

---

There are no express warranties except as listed above. The Warrantor will not be liable for incidental or consequential damages (including, without limitation, damage to recording media) resulting from the use of these products, or arising out of any breach of the warranty. All express and implied warranties, including the warranties of merchantability and fitness for particular purpose, are limited to the applicable warranty period set forth above.

Some states do not allow the exclusion or limitation of incidental or consequential damages or limitations on how long an implied warranty lasts, so the above exclusions or limitations may not apply to you. This warranty gives you specific legal rights, and you may also have other rights from vary from state to state.

If the problem is not handled to your satisfaction, then write to the following address:

Digital Watchdog, Inc.  
ATTN: RMA Department  
16220 Bloomfield Ave  
Cerritos, CA 90703

Service calls which do not involve defective materials or workmanship as determined by the Warrantor, in its sole discretion, are not covered. Cost of such service calls are the responsibility of the purchaser.



*Complete Surveillance Solutions*

DW® east coast office and warehouse: 5436 W Crenshaw St, Tampa, FL 33634

DW® west coast office and warehouse: 16220 Bloomfield Ave., Cerritos, California, USA 90703

PH: 866-446-3595 | FAX: 813-888-9262

[www.Digital-Watchdog.com](http://www.Digital-Watchdog.com)

[technicalsupport@dwcc.tv](mailto:technicalsupport@dwcc.tv)

Technical Support PH:

USA & Canada 1+ (866) 446-3595

International 1+ (813) 888-9555

French Canadian 1+ (514) 360-1309

Technical Support hours: Monday-Friday 9:00am to 8:00pm Eastern Standard Time