

HIGH DEFINITION ANALOG Multi-Sensor Outdoor Dome Camera

DWC-VS753WT



 **STAR-LIGHT FLEX™**

Super Low Light Configurable HD Analog Camera

ABOUT MANUAL

Before installing and using the camera, please read this manual carefully.
Be sure to keep it handy for future reference.

SAFETY INFORMATION



CAUTION
RISK OF ELECTRIC SHOCK. DO NOT OPEN.



CAUTION:
TO REDUCE THE RISK OF ELECTRIC SHOCK, DO NOT REMOVE COVER (OR BACK)
NO USER SERVICEABLE PARTS INSIDE. REFER SERVICING TO QUALIFIED
SERVICE PERSONNEL.



Warning

This symbol indicated that dangerous voltage consisting a risk of electric shock is present within this unit.



Precaution

This exclamation point symbol is intended to alert the user to the presence of important operating and maintenance (service) instructions in the literature accompanying the appliance.



Warning

Magnets could affect the function of pacemakers and implanted heard defibrillator. A pacemaker could switch into test mode and cause illness.

A heart defibrillator may stop working.

If you wear these devices, keep a sufficient distance from the magnets.

Warn others who wear these devices from getting too close to the magnets

WARNING

To prevent damage which may result in fire or electric shock hazard, do not expose this appliance to rain or moisture.

1. Be sure to use only the standard adapter that is specified in the specifications. Using any other adapter could cause fire, electrical shock, or damage to the product.
2. Incorrectly connecting the power supply or replacing battery may cause explosion, fire, electric shock, or damage to the product.
3. Do not connect multiple cameras to a single adapter. Exceeding the capacity may cause excessive heat generation or fire.
4. Securely plug the power cord into the power receptacle. Insecure connection may cause fire.
5. When installing the camera, fasten it securely and firmly. A falling camera may cause personal injury.
6. Do not place conductive objects (e.g. screw drivers, coins, metal items, etc.) or containers filled with water on top of the camera. Doing so may cause personal injury due to fire electric shock, or falling objects.



SAFETY INFORMATION

WARNING (CONT.)

7. Do not install the unit in humid, dusty, or sooty locations. Doing so may cause fire or electric shock.
8. If any unusual smells or smoke come from the unit, stop using the product. Immediately disconnect the power source and contact the service center. Continued use in such a condition may cause fire or electric shock.
9. If this product fails to operate normally, contact the nearest service center. Never disassemble or modify this product in any way.
10. When cleaning, do not spray water directly onto parts of the product. Doing so may cause fire or electric shock.

PRECAUTION

Operating

- Before using, make sure power supply and all other parts are properly connected.
- While operating, if any abnormal condition or malfunction is observed, stop using the camera immediately and contact your dealer.

Handling

- Do not disassemble or tamper with parts inside the camera.
- Do not drop the camera or subject it to shock or vibration as this can cause damage to the camera.
- Clean the clear dome cover with extra care. Scratches and dust can ruin the quality of the camera image.

Installation and Care

- Do not install the camera in areas of extreme temperature, exceeding the allowed range.
- Avoid installing in humid or dusty environments.
- Avoid installing in places where radiation is present.
- Avoid installing in places where there are strong magnetic fields and electric signals.
- Avoid installing in places where the camera would be subject to strong vibrations.
- Never expose the camera to rain or water.



This equipment has been tested and found to comply with the limits for a Class A digital device, pursuant to part 15 of the FCC Rules.

These limits are designed to provide reasonable protection against harmful interference when the equipment is operated in a commercial environment.

This equipment generates, uses, and can radiate radio frequency energy and, if not installed and used in accordance with the instruction manual, may cause harmful interference to radio communications. Operation of this equipment in a residential area is likely to cause harmful interference in which case the user will be required to correct the interference at his own expense.

TABLE OF CONTENTS

Introduction	Features	5
	Parts and Descriptions	6
	Dimensions	7
Installation	Inside the Box	8
	Installation Instructions	9
	Cabling	10-11
	Connecting to Monitors	12
	Adjusting the Camera Angle	13
	How to Access the Camera's OSD Menus	14-15
Module OSD Menu		16-27
Troubleshooting		28
Warranty Information		29-30
Specifications		31



FEATURES*

- High Definition Analog (HD Analog) HD over Coax Technology
- Four Cameras in One, One Installation
- 4x Panasonic® 1/3" CMOS Sensor
- Flexible Sensor Positioning with Magnets
- 8 Megapixel Resolution at 30fps (4x 2.1MP)
- 4x 2.8mm, 4.0mm, 6.0mm and 8.0mm Fixed Lenses Options
- Customizable 2.8mm, 4.0mm, 6.0mm and 8.0mm Lens Options
- OSD Control Via Coaxial (UTC)
- Easy Icon Driven OSD Menu with Built-in Joystick
- Secondary Video-BNC Output
- STAR-LIGHT™ Super Low Light Technology
- True Day/Night Mechanical IR Cut Filter
- Dynamic Range Compressor (DRC) Reveals Low Light Detail
- Wide Dynamic Range (WDR)
- Smart DNR™ 3D Digital Noise Reduction
- Highlight Masking Exposure (HME)
- Programmable Privacy Zones
- Auto Gain Control (AGC)
- Backlight Compensation (BLC)
- Auto White Balance (AWB)
- RS-485 Built-in
- Auto Sensing 24VAC/12VDC with Line Lock
- De-Fog™ Extreme Weather Image Compensation
- IP66 Certified (Weather Resistant)

PARTS & DESCRIPTION*

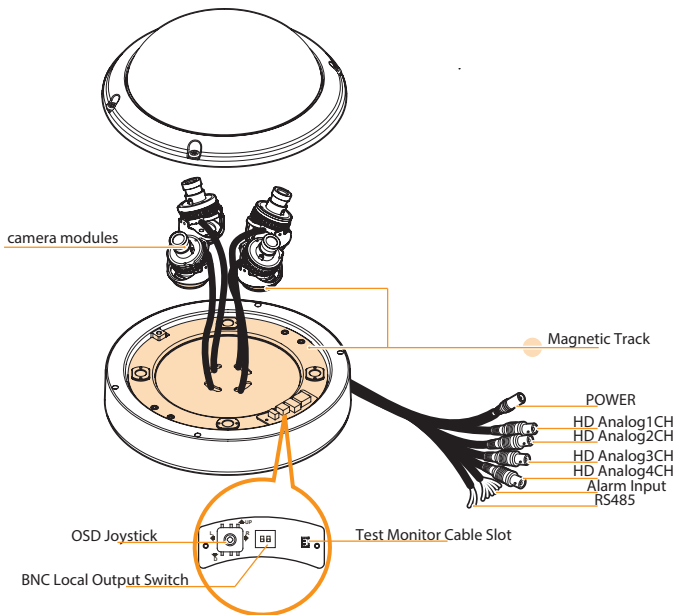

DIMENSIONS IN MILLIMETERS (IN)*

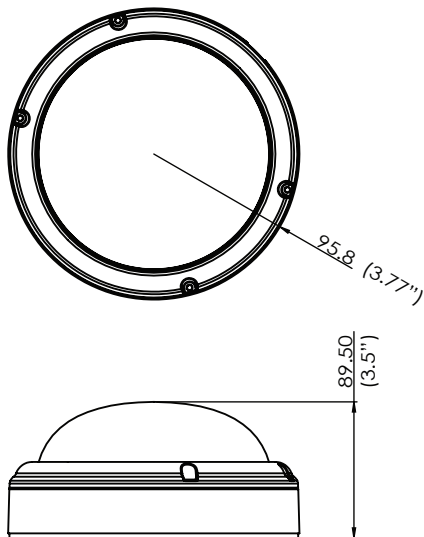

INSIDE THE BOX*

Included with your camera:

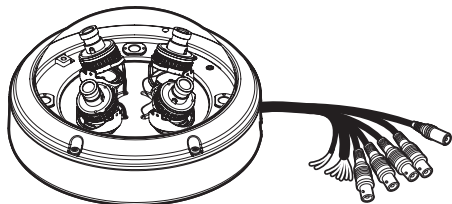

Camera

Cables



Torx Wrench

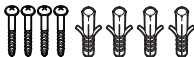

Screw &
Plastic Anchor-4pcs



Test Video Cable

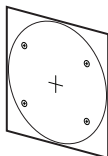

Mounting Template



Installation Manual

INSTALLATION*

1. Using the mounting plate or the camera's bottom case, mark and drill holes into the mounting surface.
2. Pull wires through and make all necessary connections. See pages 9-10 for more information.
3. Using the four (4) included screws, mount the camera's bottom case to the mounting surface.
4. Adjust the camera module on the magnetic surface for the ultimate coverage and view. Each camera module snaps into position using the magnetic track, allowing for maximum customization and fully adjustable views. See page 12 for tilting and adjustment specifications.
5. Secure the cover dome to the camera's bottom case using the torx wrench.
6. Remove the protective film from the camera's dome to complete the installation.

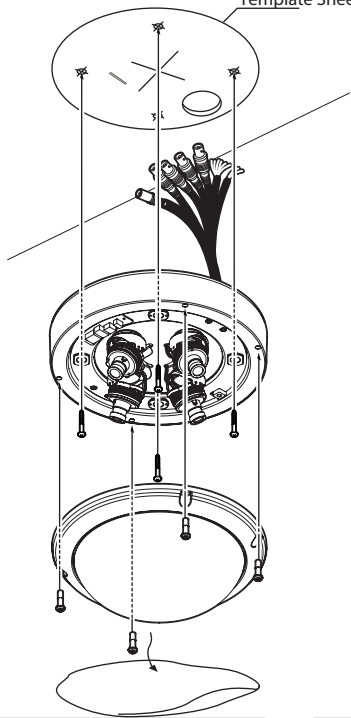

INSTALLATION-CONNECTING CABLES*

Use the diagram below to connect the camera to external devices:

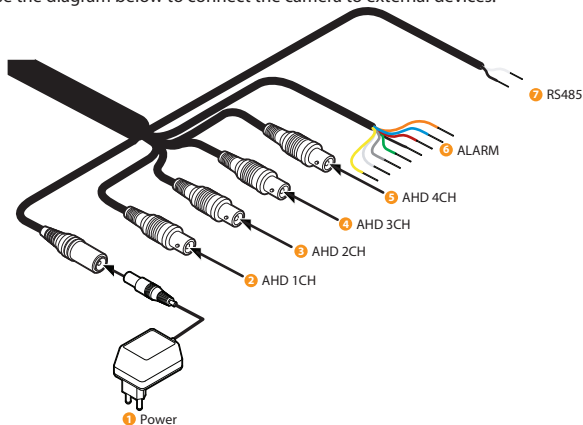

1. Power: connect the camera to a proper power supply. The camera supports both 12VDC and 24VAC. Below are the maximum power supplies for the camera:

DC12V : 8.36W

AC24V : 8.36W

2~5. AHD BNC Outputs 1~4: Connect each of the camera's lenses as a separate output to a

DVR supporting AHD signal such as the VMAX A1. On the DVR side, each lens will be set as a different channel.

INSTALLATION-CONNECTING CABLES*

Use the diagram below to connect the camera to external devices:

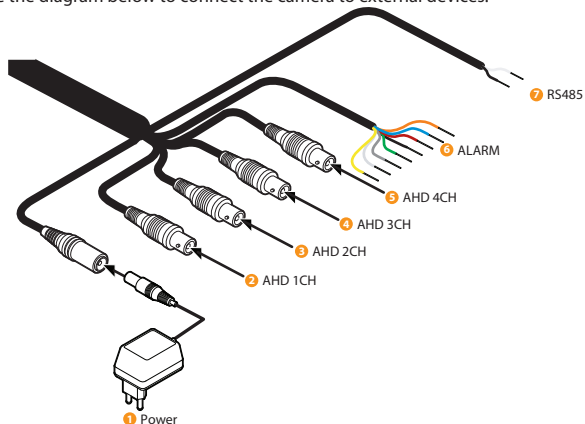

6. Alarm Input: Connect a sensor/alarm input device to the camera's alarm in+ and - cables.

1# DOUT +	ORANGE	3# DOUT +	GREEN
1# DOUT -	RED	3# DOUT -	GRAY
2# DOUT +	YELLOW	4# DOUT +	WHITE
2# DOUT -	BLUE	4# DOUT -	BLACK

7. RS485 Connectors: Connect the camera to a controller or the DVR using RS485.

CONNECTING TO MONITORS*

Use the diagram below to connect to a Monitor or CRT Monitor properly.

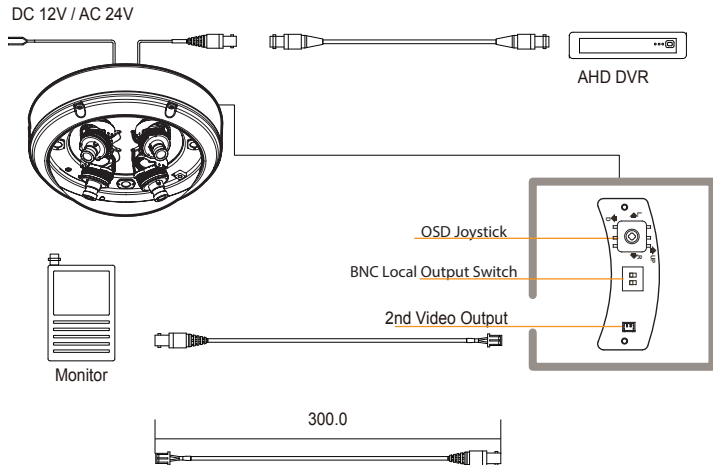

- Power Connection - 12VDC/24VAC Dual Voltage (Auto Polarity Detection and Protection)
- All cameras are equipped with a second video output for on-site configuration.

ADJUSTING THE CAMERA ANGLE*

Each Lens module can be tilted and rotated as follow:

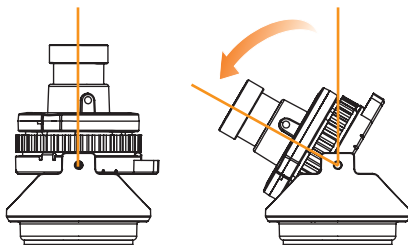

Tilting 60°

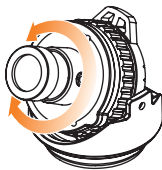

Rotation 360°

HOW TO ACCESS THE CAMERA'S OSD MENUS*

The camera has four separate sensors, each with its own OSD menu and settings. When adjusting the camera's settings, each lens/ sensor will have their own set of values and settings and will be set separately.

To access each sensor's OSD menu select one of the following options:

1. The camera has four (4) BNC outputs, each supporting UTC (Up the Coax) communication. When the camera is connected to a DVR supporting UTC communication like the VMAX A1™ All-in-One DVR, you can access the camera's OSD menu directly from the DVR.
2. The camera supports RS485 communication, allowing to control the camera remotely.
3. In the camera's external control board, there is a switch next to the joystick controller. The switch determines which of the four (4) sensors will be displayed in the secondary BNC output. Once the switches are set to a specific sensor, press the joystick controller to view the sensor's OSD menu. The sensor's display will appear at the top left corner of the display for 60 sec.

Refer to the images in the next page for more information on the switch settings for each sensor selection.

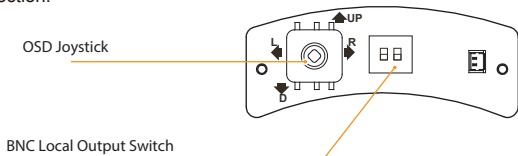

HOW TO ACCESS THE CAMERA'S OSD MENUS*

Use the images below to set the BNC Local Output Switch to the desired sensor. Once the switches are set to a specific sensor, press the joystick controller to view the sensor's OSD menu. The sensor's display will appear at the top left corner of the display for 60 sec.



BNC Local Output for Sensor #1

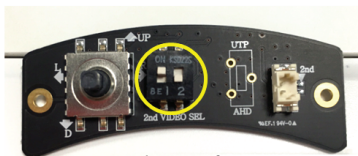

BNC Local Output for Sensor #2

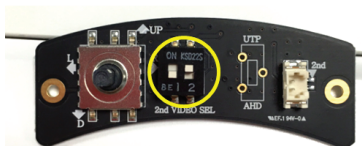

BNC Local Output for Sensor #3

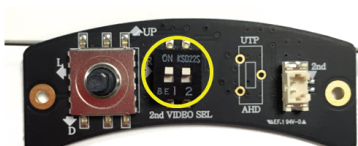

BNC Local Output for Sensor #4

MODULE OSD MENU*

EXPOSURE	COLOR	DAY & NIGHT	FUNCTION
<ul style="list-style-type: none"> — LENS BRIGHTNESS / SHUTTER / FOCUS ADJ. — BACKLIGHT OFF / HME / BLC / WDR — DRC OFF / LOW / MIDDLE / HIGH — DEFOG OFF / ON — AGC 0~10 — STARLIGHT OFF / x2 ~ x32 — 3D DNR OFF / LOW / MIDDLE / HIGH — EXIT JUMP SAVE & EXIT / EXIT 	<ul style="list-style-type: none"> — WB BAL. AUTO / AUTO-EX / PRESET / MANUAL — COLOR GAIN 0 ~ 20 — EXIT JUMP SAVE & EXIT / EXIT 	<ul style="list-style-type: none"> — D&N MODE AUTO / COLOR / BW — AGC THRES 0 ~ 20 — AGC MARGIN 0 ~ 20 — DELAY LOW / MIDDLE / HIGH — SMART IR 0 ~ 20 — EXIT JUMP SAVE & EXIT / EXIT 	<ul style="list-style-type: none"> — SHARPNESS 0 ~ 20 — GAMMA 0.45 ~ 0.75 — MIRROR OFF / ON — FLIP OFF / ON — D. ZOOM x1.0 ~ x16.0 — EXIT JUMP SAVE & EXIT / EXIT
MOTION	PRIVACY	SETUP	EXIT
<ul style="list-style-type: none"> — MOTION OFF / ON — DET. WINDOWS — SENSITIVITY 0 ~ 10 — MOTION OSD OFF / ON — TEXT ALARM OFF / ON — SIGNAL OUT OFF / ON — EXIT JUMP SAVE & EXIT / EXIT 	<ul style="list-style-type: none"> — BOX OFF / ON — POLYGON OFF / ON — EXIT JUMP SAVE & EXIT / EXIT 	<ul style="list-style-type: none"> — CAM TITLE OFF / ON — FRAME RATE 1080_30P / 720_30P — FREQUENCY 50Hz / 60Hz — LANGUAGE ENG / CHN / CHN (S) / JPN — DEFECT DET ON — INITIAL ON — EXIT JUMP SAVE & EXIT / EXIT 	<ul style="list-style-type: none"> — SAVE — RESTORE — EXIT



EXPOSURE

LENS

The camera's lens mode is set by default to AUTO. This allows the camera's iris automatically.



Under the LENS sub-menu, you can adjust the following settings:

- Brightness: Adjust the camera's brightness from 0~20. The higher the number, the brighter the image will appear.
- Shutter: Set the shutter speed to AUTO, Manual, or FLC (Flicker-less mode).
 - If AUTO is selected:
 - Select NORMAL for **INDOOR** applications.
 - Select DEBLUR for **OUTDOOR** applications.
 - If MANUAL is selected, set the shutter speed from the options: 1/30,1/60, 1/120 ~ 1/30000.
- Focus Adjustment: When on, the default level is set automatically by controlling lens focus and based on the installation and environment circumstances.

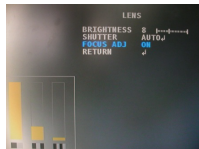



EXPOSURE

BACKLIGHT

OFF

HME

HIGHLIGHT MASKING EXPOSURE

HME allows objects to appear clearly on the screen by masking extremely bright areas. To setup HME, set the level and color. The lower the setting, the darker the masking areas have to be. Select from: 0 ~ 10.

Color: Set the color of the HME mask. Select from:

BLACK / WHITE / YELLOW / CYAN / GREEN /
MAGENTA / RED / BLUE



BLC BACK LIGHT COMPENSATION

If BLC is selected, adjust the size and position of the mask:

- H-POS: Move the Zone position left or right. The higher the number, the zone will move to the right.
- V-POS: Move the Zone position up or down. The higher the number, the zone will move down.
- H-Size: Reset the zone's size horizontally. The higher the number, the right side panel will move further to the right.
- V-Size: Reset the zone's size vertically. The higher the number, the bottom side panel will move further down.



WDR Wide Dynamic Range

If WDR is selected, adjust the WDR level (Weight) in the sub-menu. Select from Low, Middle, or High (Default).



EXPOSURE

DRC

DYNAMIC RANGE COMPRESSOR

DRC enables dark areas in images to become more visible without overexposing the bright areas to create one perfect image. Select from: OFF / ON.

NOTE: If WDR or DEFOG are enabled, the DRC settings are set automatically and will not be available for adjustment.

DEFOG

Allows the camera to process a scene that is obscured by fog or weather conditions and provides a visibly improved image.

AUTO / Manual: Select AUTO to have the WDR and DRC levels adjusted automatically. Set the DEFOG level from LOW / MIDDLE / HIGH.

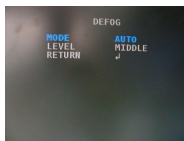

AGC

AUTO GAIN CONTROL

0~10

AGC enhances the picture brightness in low light conditions. A higher level AGC setting makes the images brighter; however, it could increase the amount of noise.

STARLIGHT

OFF / x2 ~ x34
(Default: X4)

Automatically activates slow shutter function when the image is too dark. High values are not recommended as they may cause the image to lag. Starlight menu cannot be controlled if the SHUTTER setting is above 1/60.

3D DNR

OFF / LOW /
MID / HIGH

3D DIGITAL NOISE REDUCTION

3D-DNR reduces the noise on the screen in low light conditions and allows for clearer images, even at night.



COLOR

WB MODE

AUTO Auto Tracking White Balance Control mode compensates for color temperature changes between 2400K° and 11000K°.

AUTO-EX Auto White Balance Control mode compensates for color temperature changes lower than 2000K° and higher than 15000K°.

PRESET Preset fixes the white balance based on the current lighting automatically.

MANUAL Users can control the white balance manually by changing RED GAIN and BLUE GAIN (see below).

C-TEMP: Select the color temperature for the white balance setup. If enabled, the Red and Blue Gain settings will be set automatically according to the C-TEMP selected. Select from 3000K, 5000K, or 8000K. The default value is 5000K.
RED GAIN: 0 ~ 20. Adjusts the amount of red in the image. The default value is 10.
BLUE GAIN: 0 ~ 20. Adjust the amount of blue in the image. The default value is 10.

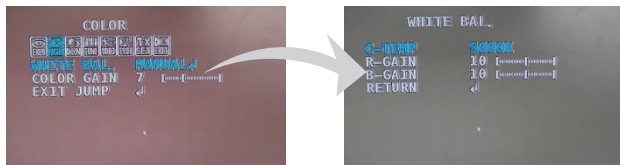

COLOR GAIN

Set the color gain from 0~20. The default value is 7.



DAY & NIGHT

D&N MODE

AUTO / COLOR / B&W

AUTO: The camera will switch between color and B/W based on the AGC levels.

- AGC THRESHOLD: Set when the camera switches between Day & Night.
- AGC MARGIN: Set the value added to the AGC Threshold. Adjust the value based on the environment in which the camera is installed. If the margin is too low, the camera will switch from color to B/W and back.
- DELAY: Set the time interval delay before switching from day mode to night mode.
- SMART IR: Enable Smart IR and set the level. Higher values will make Smart IR stronger.

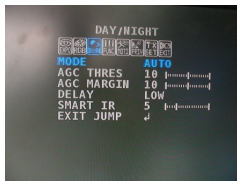

COLOR: The camera will remain in COLOR mode regardless of the lighting environment.

B/W: The camera will remain in B/W mode regardless of the lighting environment.



FUNCTION

SHARPNESS

0 ~ 20 Sets the image sharpness. The higher the number, the sharper the image.

GAMMA

0.45 ~ 0.75 Select the desired gamma level. 0.5 is default setting.

MIRROR / FLIP

OFF

MIRROR Reflects the camera horizontally.

FLIP Reflects the camera vertically.



Mirror / Flip OFF



Mirror ON



Flip ON



Mirror & Flip ON

D-Zoom

x1 ~ x16 Enable or Disable Digital zoom to the camera's field of view. By default, the zoom will go to the center of the camera's Field of View.



MOTION

The camera can detect motion and display an alarm on the screen.

Motion detection settings must be adjusted for each sensor.

DET. WINDOW

- WINDOW ZONE: Select a zone to setup from the 4 zones available.
- WINDOW USE: Enable or disable the selected motion zone.
- DET H-POS: Move the Zone left or right. The higher the number, the zone will move to the right.
- DET V-POS: Move the Zone up or down. The higher the number, the zone will move down.
- DET H-Size: Adjust the zone's size horizontally. The higher the number, the right side panel will move further to the right.
- DET V-Size: Adjust the zone's size vertically. The higher the number, the bottom side panel will move further down.

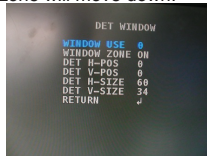
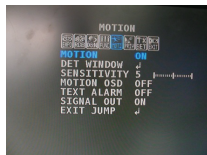

SENSITIVITY

The smaller the movement you want to detect, the higher the sensitivity value must be.

MOTION OSD

If enabled, the text MOTION ZONE will appear on the screen indicating the area of motion detection.

TEXT ALARM

Setup a text to appear on the screen when motion is detected explaining the alarm situation.

- WINDOW MOTION: Will appear when a motion alarm is detected.
- CAMERA MOVING: Will appear if the camera is shaken abruptly.
- BRIGHT CHANGE: Will appear if the brightness in the scene changes suddenly and drastically.



PRIVACY

You can hide some parts of the screen for privacy masking. A total of 8 different privacy masking zones are available. The cameras support square privacy masks or advanced polygon masks.



BOX

- ZONE NUM.: Select the zone number you want to setup.
- ZONE DISP.: To enable it, turn the display option ON.
- H-POS: Move the Zone position Left or right. The higher the number, the zone will move to the right.
- V-POS: Move the Zone position up or down. The higher the number, the zone will move down.
- H-SIZE: Reset the zone's size horizontally. The higher the number, the right side panel will move further to the right.
- V-SIZE: Reset the zone's size vertically. The higher the number, the bottom side panel will move further down.
- Y LEVEL- The higher the number, the brighter the color will appear.
- CR LEVEL- The higher the number, the more red tone will be added to the zone's color. The lower the number, the more green will be added to the zone's color.
- CB LEVEL- High CB Level + High CR Level = Red
High CB Level + Low CR Level = Blue
Low CB Level + High CR Level = Orange
- TRANS: Set the mask's transparency level from 0~3. The default value is 2.



PRIVACY

You can hide some parts of the screen for privacy masking. A total of 8 different privacy masking zones are available. The cameras support square privacy masks or advanced polygon masks.

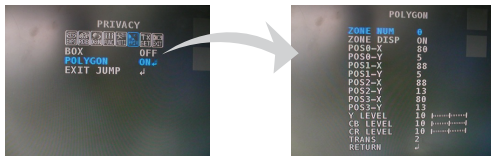

POLYGON MASKS

- ZONE NUM.: Select the zone number you want to setup.
- ZONE DISP.: To enable it, turn the display option ON.
- POS0-X: Move the mask's upper left angle left to right.
- POS0-Y: Move the mask's upper left angle up and down.
- POS1-X: Move the mask's upper right angle left to right.
- POS1-Y: Move the mask's upper right angle up and down.
- POS2-X: Move the mask's lower right angle left to right.
- POS2-Y: Move the mask's lower right angle up and down.
- POS3-X: Move the mask's lower left angle left to right.
- POS3-Y: Move the mask's lower left angle up and down.
- Y LEVEL- The higher the number, the brighter the color will appear.
- CR LEVEL- The higher the number, the more red tone will be added to the zone's color. The lower the number, the more green will be added to the zone's color.
- CB LEVEL- High CB Level + High CR Level = Red
 High CB Level + Low CR Level = Blue
 Low CB Level + High CR Level = Orange
- TRANS: Set the mask's transparency level from 0~3. The default value is 2.



SETUP

CAM. TITLE

Add a name to the camera. Set the title by using the OSD joystick.

FRAME RATE

Select the camera's frame rate from 1080p at 30fps (default) or 720p at 30fps.

FREQUENCY

When the camera's image has flickering issues, change the frequency value to adjust the image. Frequency setup menu is available on the 1st sensor only. Settings adjusted in the 1st sensor will be applied to the other sensors accordingly.

LANGUAGE

Select from the following: English (Default), Chinese, Chinese (S), and Japanese.

DEFECT DET.

The camera can detect and correct dead pixels in the image. Press the select button and set the threshold level. The camera will detect and adjust the pixels automatically.

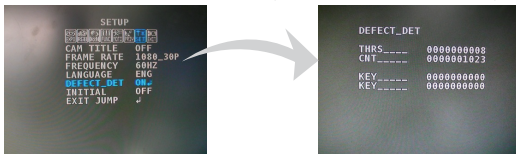

INITIAL

Reset the camera to its default settings. Press and hold the select button for five (5) seconds.



EXIT

EXIT
SAVE&EXIT

Exit the OSD menu without saving any changes.
Exit the OSD menu after saving the recent changes.

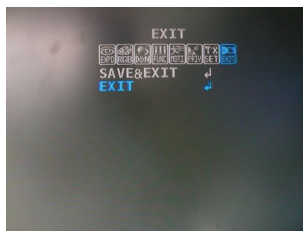
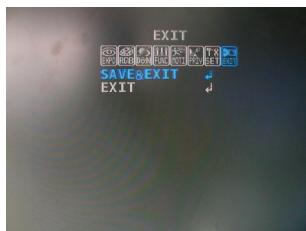

TROUBLESHOOTING

Before sending your camera for repair, check the following or contact our technical specialist.

FOR NO VIDEO

Check the coaxial cable and make sure it is connected securely.

Check the lens' iris adjustment at the camera's OSD menu.

Check the power supply and make sure the camera has the proper voltage and current.

Check UTP/COAX switch inside the camera's housing and confirm the switch's position matches the signal connection type.

FOR OUT-OF-FOCUS VIDEO

Check the clear dome cover and the lens for dirt or fingerprints. Use a soft cloth and gently clean. Check the lens' manual focal and zoom adjustment. The use of a field test monitor is recommended.



WARRANTY INFORMATION*

Digital Watchdog (referred to as “the Warrantor”) warrants the Digital Watchdog Camera against defects in materials or workmanship as follows:

LABOR: For the initial five (5) years and one (1) year on IR LED from the original purchase date, if the camera is determined to be defective, the Warrantor will repair or replace the unit with a new or refurbished product at its option at no charge.

PARTS: In addition, the Warrantor will supply replacement parts for the initial five (5) years and one (1) year on IR LED.

To obtain warranty or out of warranty service, please contact a Technical Support Representative at **1-866-446-3595** Monday through Friday from 9:00AM to 8:00PM Eastern Standard Time.

A purchase receipt or other proof of the original purchase date is required before warranty service is rendered. This warranty only covers failures due to defects in materials and workmanship which arise during normal use. This warranty does not cover damage which occurs in shipment or failures which are caused by products not supplied by the Warrantor or failures which result from accident, misuse, abuse, neglect, mishandling, misapplication, alteration, modification, faulty installation, set-up adjustments, improper antenna, inadequate signal pickup, maladjustment of consumer controls, improper operation, power line surge, improper voltage supply, lightning damage, rental use of the product or service by anyone other than an authorized repair facility or damage that is attributable to acts of God.

LIMITS & EXCLUSIONS*

There are no express warranties except as listed. The warrantor will not be liable for incidental or consequential damages (including damage to recording media without limitation) resulting from the use of these products or arising out of any breach of the warranty. All express and implied warranties, including the warranties of merchantability and fitness for particular purpose, are limited to the applicable warranty period set forth above.

Some states do not allow the exclusion or limitation of incidental or consequential damages, or limitations on how long an implied warranty lasts, so the exclusions or limitations listed above may not apply to you. This warranty gives you specific legal rights, and you may also have other rights that vary from state-to-state.

If the problem is not handled to your satisfaction, then write to the following address:

Digital Watchdog, Inc.
ATTN: RMA Department
5436 W. Crenshaw Street
Tampa, FL 33634

Service calls which do not involve defective materials or workmanship as determined by the Warrantor, in its sole discretion, are not covered. Costs of such service calls are the responsibility of the purchaser.



SPECIFICATIONS*

VIDEO	
Image Sensor	4x Panasonic 1/3" CMOS Sensors
Active Pixels	4x 1944(H) x 1092(V)
Scanning System	Progressive scan
Frequency	60Hz/50Hz
Signal Technology	8 Megapixel HD Analog (4 x 2MP Sensors)
Synchronization	Internal
Resolution	8.0 Megapixel (4x 1920x1080 Sensors)
Minimum Scene Illumination	F2.0 (30IRE): 0.06Lux (Color), 0.01 Lux (B&W)
Video Output	4x HD Analog 1080p at 30fps
Alarm Output	4x Alarm Outputs
LENS	
Focal Length & Lens Type	4x 2.8mm / 4.0mm / 6.0mm /8.0mm/ Fixed Lenses
ENVIRONMENTAL	
Operating Temperature & Humidity	-20°C ~ 50°C (-4°F ~ 122°F), No more than 90%
IP Rating	IP66 (Weather Resistant)
Other Certifications	FCC, CE, ROHS
ELECTRICAL	
Power Requirements	DC12V/AC24V Dual Voltage
Power Consumption	DC12V: 8.36W, 696mA, AC24V: 8.36W, 348mA
MECHANICAL	
Housing Material and Dimensions	Aluminum, 7.48 x 3.54 Inch (190 x 90mm)
Weight	4.4 lbs (2kg)

*Specification is subject to change without prior notice.



Headquarters Office: 5436 W Crenshaw St, Tampa, FL 33634
Sales Office: 16220 Bloomfield Ave., Cerritos, California, USA 90703

PH: 866-446-3595 | FAX: 813-888-9262

www.Digital-Watchdog.com

technicalsupport@dwcc.tv

Technical Support PH:

USA & Canada +1 (904) 999-1309

International 1+ (813) 888-9555

French Canadian 1+ (514) 360-1309

Technical Support Hours: Monday-Friday
9:00am to 8:00pm Eastern Standard Time