

## RadioRA<sup>2</sup> Wall-mount Designer Keypads

RadioRA<sup>2</sup> wall-mount designer keypads provide homeowners with a simple and elegant way to operate lights, shades/draperies, motorized screens, and many other devices.

RadioRA<sup>2</sup> keypads feature large, easy-to-use buttons, plus a unique backlit engraving option that makes the keypads readable any time of the day or night. The keypad buttons are rounded, allowing engraving to be displayed at an upward angle, increasing readability.

Replacement Kits are available in a variety of colors and with custom engraving to clearly identify each button's function. The flexible design of the keypads allow the color, number of buttons, and the configuration of the buttons to be changed after the keypad is installed.

Use only Lutron<sup>®</sup> Designer (Claro<sup>®</sup> or Satin Colors<sup>®</sup>) wallplates. The mechanical design of the keypad is ONLY compatible with Lutron<sup>®</sup> wallplates and is NOT compatible with any other manufacturer's wallplate. Wallplates are sold separately. Lutron<sup>®</sup> Claro<sup>®</sup> and Satin Colors<sup>®</sup> wallplates snap on with no visible means of attachment.



### Model Numbers

|                  |                                  |
|------------------|----------------------------------|
| RRD-W1RLD-XX*    | Dual group with 1 Raise/Lower    |
| RKD-W1RLD-XX*-E  | Engraved Replacement Kit         |
| RRD-W2RLD-XX*    | Dual group with 2 Raise/Lower    |
| RKD-W2RLD-XX*-E  | Engraved Replacement Kit         |
| RRD-W3BD-XX*     | 3 Button dual group              |
| RKD-W3BD-XX*-E   | Engraved Replacement Kit         |
| RRD-W3BRL-XX*    | 3 Button with Raise/Lower        |
| RKD-W3BRL-XX*-E  | Engraved Replacement Kit         |
| RRD-W3BSRL-XX*   | 3 Button with Raise/Lower Keypad |
| RKD-W3BSRL-XX*-E | Engraved Replacement Kit         |
| RRD-W4S-XX*      | 4 Scene with Raise/Lower Keypad  |
| RKD-W4S-XX*-E    | Engraved Replacement Kit         |
| RRD-W5BRL-XX*    | 5 Button with Raise/Lower Keypad |
| RKD-W5BRL-XX*-E  | Engraved Replacement Kit         |

|                   |  |
|-------------------|--|
| RRD-W5BRLIR-XX*   | 5 Button with Raise/Lower and Infrared (IR) lens |
| RKD-W5BRLIR-XX*-E | Engraved Replacement Kit                         |
| RRD-W6BRL-XX      | 6 Button with Raise/Lower                        |
| RKD-W6BRL-XX*-E   | Engraved Replacement Kit                         |
| RRD-W7B-XX*       | 7 Button Keypad                                  |
| RKD-W7B-XX*-E     | Engraved Replacement Kit                         |

\* "XX" in the model number represents color/finish code. See **colors and finishes** at end of document.

## RadioRA<sup>2</sup> Wall-mount Designer keypads

### Specifications

|                                  |  |
|----------------------------------|--|
| <b>Model Numbers</b>             | <p><b>Keypads:</b> RRD-W1RLD-XX, RRD-W2RLD-XX, RRD-W3BD-XX, RRD-W3BRL-XX, RRD-W3BSRL-XX, RRD-W4S-XX, RRD-W5BRL-XX, RRD-W5BRLIR-XX, RRD-W6BRL-XX, RRD-W7B-XX</p> <p><b>Replacement Kits:</b> RKD-W1RLD-XX-E, RKD-W2RLD-XX-E, RKD-W3BD-XX-E, RKD-W3BRL-XX-E, RKD-W3BSRL-XX-E, RKD-W4S-XX-E, RKD-W5BRL-XX-E, RKD-W5BRLIR-XX-E, RKD-W6BRL-XX-E, RKD-W7B-XX-E</p> |
| <b>Power</b>                     | 120 V~ 50/60 Hz 0.5 A  |
| <b>Typical Power Consumption</b> | 0.6 W<br>Test conditions: all backlights on medium intensity, two LEDs on (two presets active), keypad powered at 120 V~   |
| <b>Regulatory Approvals</b>      | UL, CSA, NOM, FCC, IC, COFETEL   |
| <b>Environment</b>               | Ambient operating temperature: 32 °F to 104 °F (0 °C to 40 °C), 0% to 90% humidity, non-condensing. Indoor use only.   |
| <b>Communications</b>            | Wall-mount designer keypads communicate with the system through Radio Frequency (RF) and must be located within 30 ft (9 m) of a repeater. System devices operate on frequencies between 431.0 MHz and 437.0 MHz.  |
| <b>ESD Protection</b>            | Tested to withstand electrostatic discharge without damage or memory loss, in accordance with IEC 61000-4-2.   |
| <b>Surge Protection</b>          | Tested to withstand surge voltages without damage or loss of operation, in accordance with IEEE C62.41-1991 Recommended Practice on Surge Voltages in Low-Voltage AC Power Circuits.   |
| <b>Power Failure</b>             | Power failure memory: should power be interrupted, the keypad will return to its previous state when power is restored.  |
| <b>Mounting</b>                  | Requires a U.S. wallbox. 3 1/2 in (89 mm) deep recommended, 2 1/4 in (57 mm) deep minimum.   |
| <b>Wiring</b>                    | Wall-mount designer keypads require a neutral wire connection.   |
| <b>Warranty</b>                  | 1 Year Limited Warranty. <a href="http://www.lutron.com/resiinfo">http://www.lutron.com/resiinfo</a>   |

### Design Features

- At the press of a single button, lights fade ON or OFF to desired levels and shades/draperies open or close to desired positions.
- Light levels and shade/drapery positions can be fine-tuned by pressing and holding the raise/lower buttons.
- Programmable to select scene or room preset levels or positions.
- Adjustable backlight intensity.
- IR receivers at the front (-W5BRLIR only) and back (all models) of the keypad allow for the use of an IR remote for line-of-sight operation (front) or IR repeater kit integration (back).
- Use an IR remote to select the same programmed rooms, scenes, and raise/lower buttons as the keypad (-W5BRLIR only).
- Configurable Raise/Lower selection
  - Last button or IR room/scene (default) - devices controlled by the last button pressed or last IR room/scene selected will raise/lower.
  - Double-tap - devices controlled by a double-tapped button will raise/lower.
- Prepaid engraving included. Redeemable for one engraved Replacement Kit.

## RadioRA<sup>2</sup> Wall-mount Designer keypads

### Dimensions

All dimensions are shown as  $\frac{\text{in}}{\text{mm}}$

**Front View**

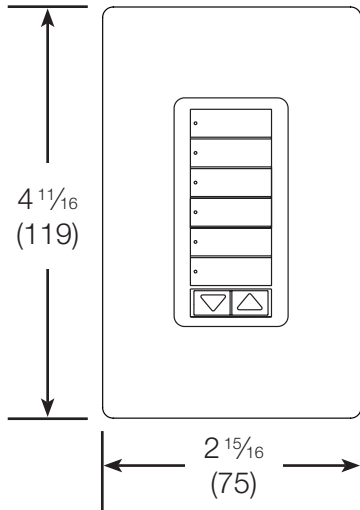

**Side View**

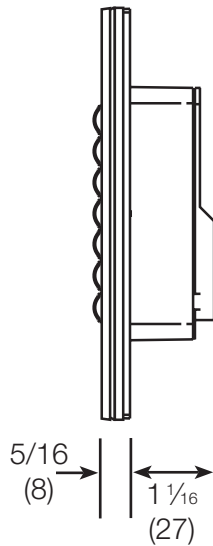

**Rear View**

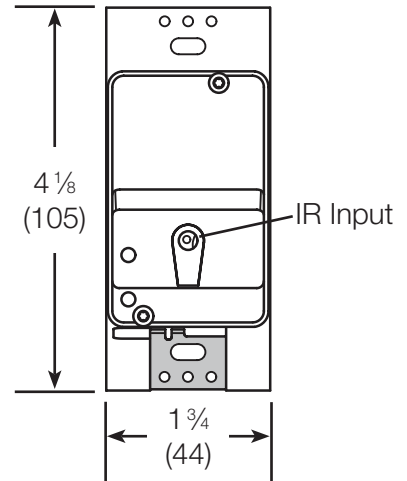

### Mounting and Parts Identification

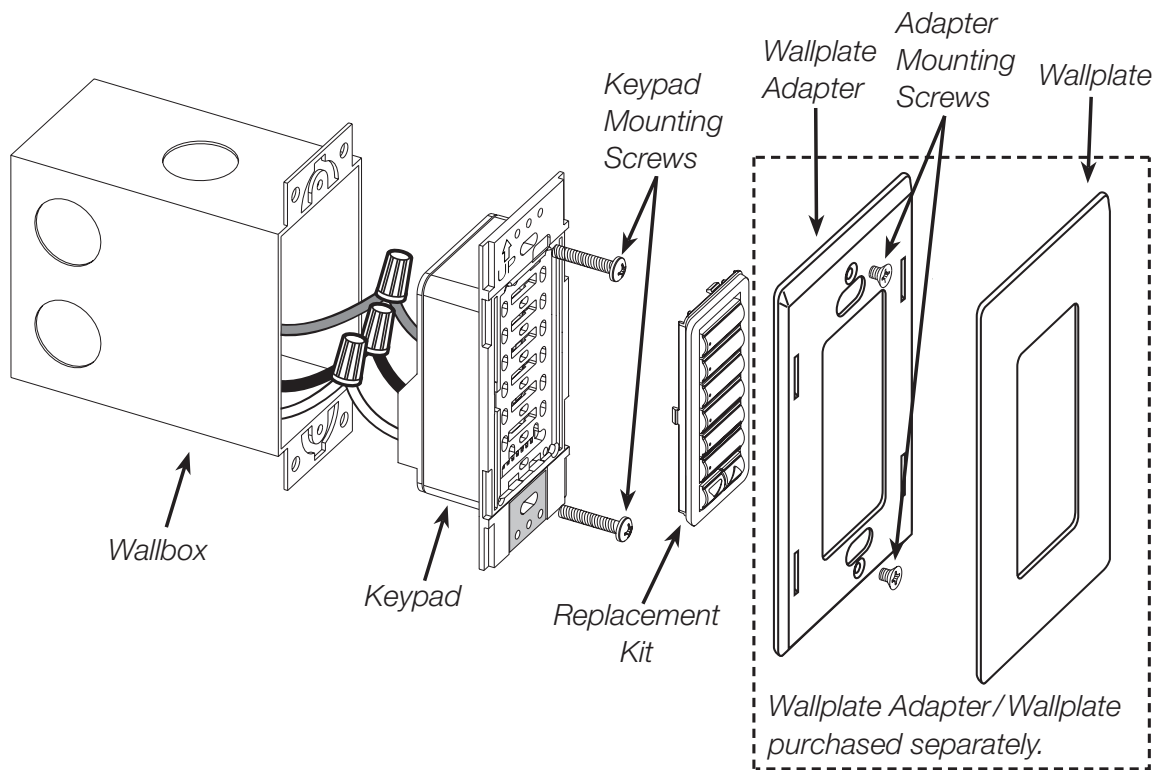

## RadioRA<sup>2</sup> Wall-mount Designer keypads

### Operation

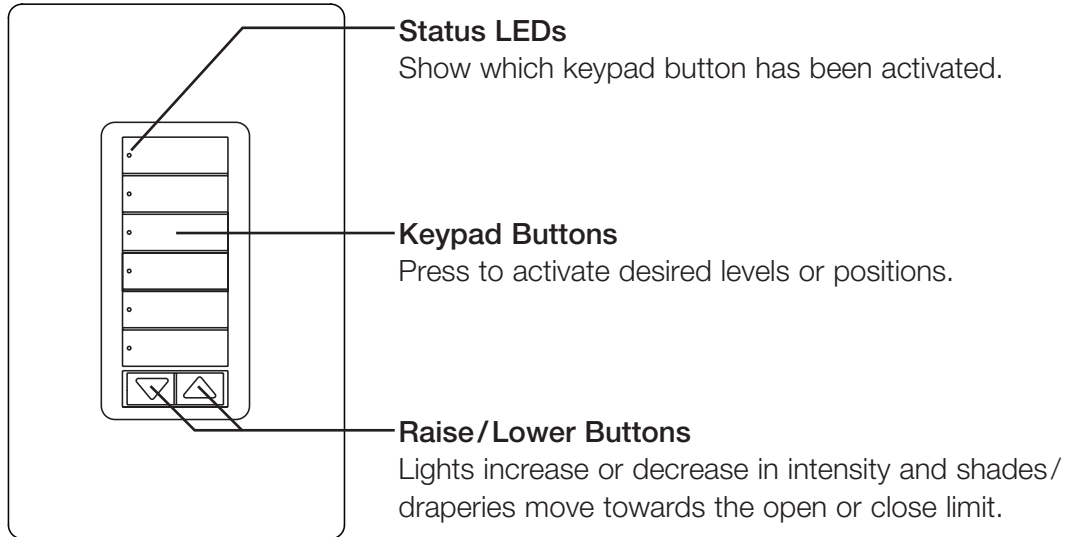

### Wiring Diagram

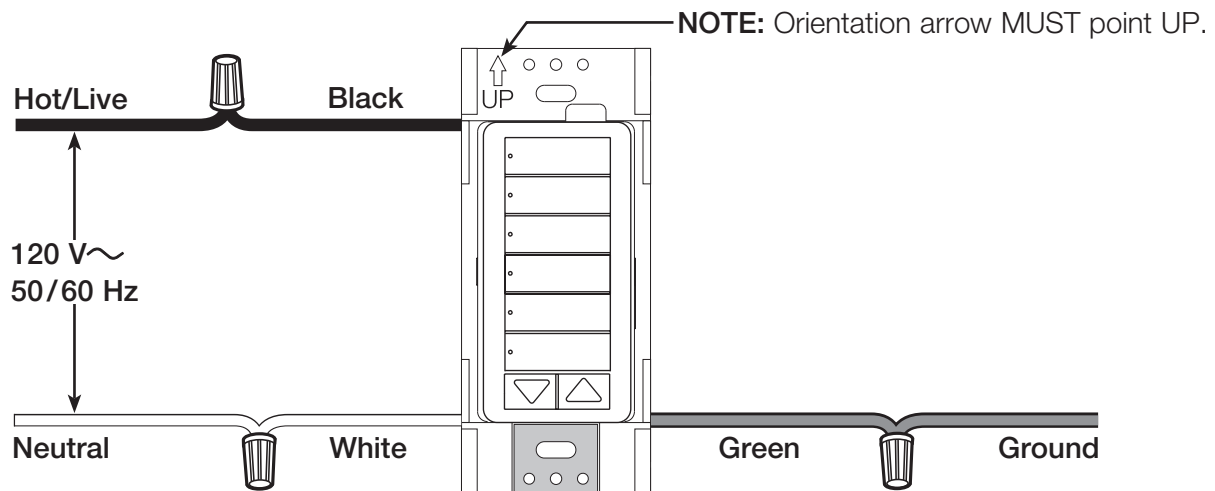

## RadioRA<sup>2</sup> Wall-mount Designer keypads

### Keypad IR Receiver

An integral feature of the RadioRA<sup>2</sup> lighting control system is to utilize keypads to receive IR signals and communicate to the rest of the RadioRA<sup>2</sup> system through RF signals. RadioRA<sup>2</sup> keypads can receive IR signals from Lutron<sup>®</sup> wireless remotes (models GRX-IT & GRX-8IT) and 3rd party learnable IR remotes.

### IR Mapping

When a keypad receives one of the supported Lutron<sup>®</sup> IR codes, it will simulate the corresponding button press as shown below. The IR receiver on the back of a keypad allows IR transmitters to mimic the functions of the buttons on the front of the keypad. For example, if RRD-W3BD is used, the IR remote maps to the three IR buttons shown below.

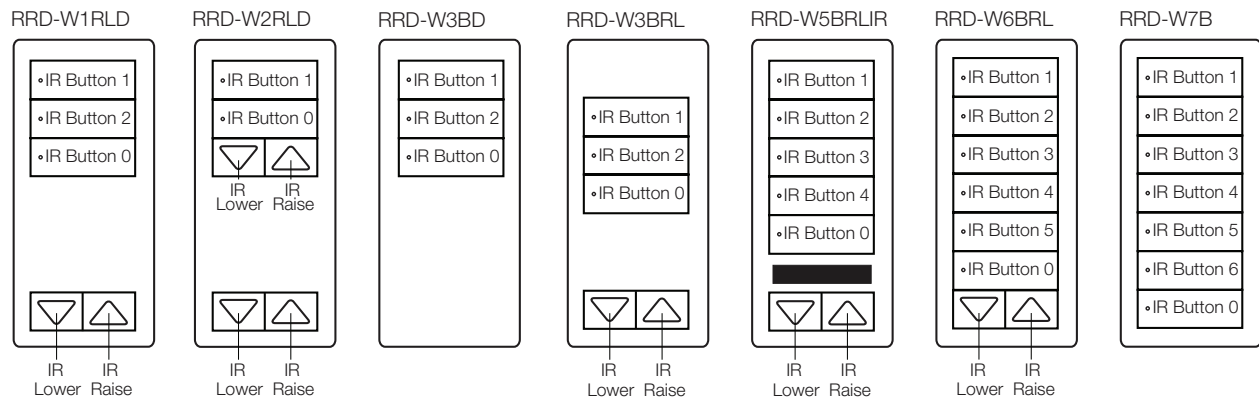

### Supported IR Remotes

RadioRA<sup>2</sup> keypads can be controlled by Lutron<sup>®</sup> IR remotes (models GRX-IT & GRX-8IT) and 3rd party learnable IR remotes.

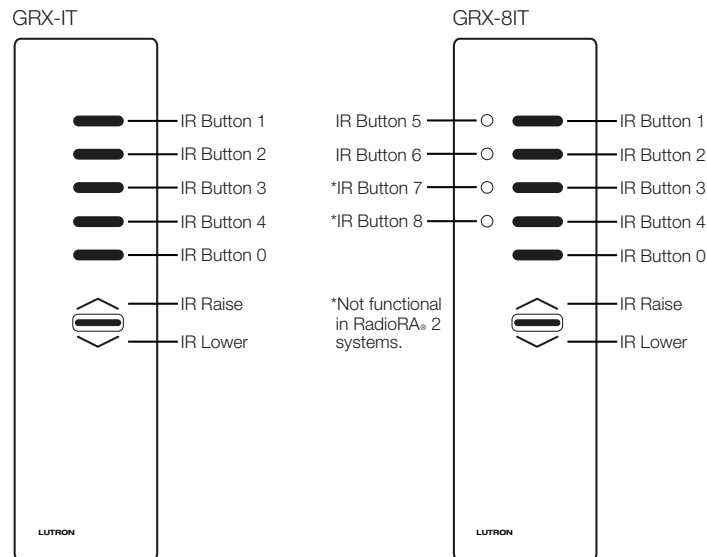

## RadioRA<sup>2</sup> Wall-mount Designer keypads

### Learnable IR Remote Codes

#### IR Technical Specifications\*

| Category             | Specification                        |
|----------------------|--------------------------------------|
| IR Carrier Frequency | 40.0 kHz                             |
| Duty Cycle           | 40%                                  |
| Single Bit Time      | 2.288 ms                             |
| Baud Rate            | 437 bps                              |
| Command Length       | 36 bits                              |
| Command Duration     | 82.368 ms                            |
| Logic One            | Presence of IR modulated at 40.0 kHz |
| Logic Zero           | Absence of IR                        |

#### IR Codes

| Remote Button | IR Code (Hexadecimal) |
|---------------|-----------------------|
| IR Button 1   | FF88BD1D0h            |
| IR Button 2   | FF88BD240h            |
| IR Button 3   | FF88BD2B0h            |
| IR Button 4   | FF88BD710h            |
| IR Button 5   | FF88BD7E0h            |
| IR Button 6   | FF88BD470h            |
| IR Button 0   | FF88BD120h            |
| IR Raise      | FF8882220h            |
| IR Lower      | FF8882140h            |

#### Single Bit Time

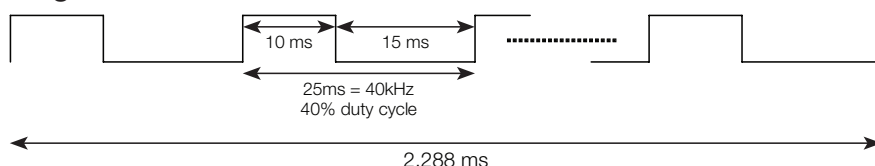

\*IR codes are transmitted from an IR remote to the IR receiver on a keypad while a button on the remote is being held down. Timeouts may occur when seven seconds of continuous IR code transmission has taken place. Therefore, it is important to transmit the most significant bit of the IR code first.

### NEC<sup>®</sup> Requirements

RadioRA<sup>2</sup> keypads can accept IR into the front or back of the unit, leading to the potential to have both electric light and power conductors and Class 2 circuit conductors in the same wallbox.

#### Solution...

The 2008 National Electrical Code<sup>®</sup> (NEC<sup>®</sup>) Article 725.136 (D) provides the specific rules governing Class 2 conductors and electric light and power conductors within the same wallbox. It states that electric light and power conductors may be allowed in the same enclosure as Class 2 circuit conductors, provided they are both introduced for connection to the same equipment, and if one of the following requirements is also met:

1. The electric light and power conductors are routed to maintain a minimum of 1/4 in (6 mm) of separation from the Class 2 circuit conductors, or:
2. The circuit conductors operate at 150 V $\sim$  or less, and meet the following requirement:  
Class 2 circuits are installed using types CL3, CL3R, CL3P or permitted substitute cables and the cable conductors extending beyond the jacket are separated by a minimum of 1/4 in (6 mm), or by a nonconductive sleeve/barrier, from all other conductors.

#### Understand though...

The NEC<sup>®</sup> is a document subject to interpretation. Your local city, county, municipality or state authorities have the final authority to approve or disapprove any installation. They must always be consulted for verification of the code, and the manner in which it will be applied in your area, prior to installation.

## RadioRA<sup>2</sup> Wall-mount Designer keypads

### Colors and Finishes

#### Gloss Finishes



White  
WH



Ivory  
IV

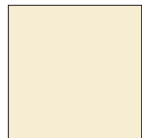

Almond  
AL



Light  
Almond  
LA

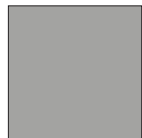

Gray  
GR



Brown  
BR



Black  
BL

#### Satin Finishes



Hot  
HT



Merlot  
MR



Plum  
PL



Turquoise  
TQ



Taupe  
TP



Eggshell  
ES



Biscuit  
BI

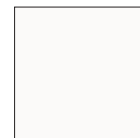

Snow  
SW



Palladium  
PD



Midnight  
MN



Sienna  
SI

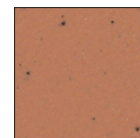

Terracotta  
TC



Greenbriar  
GB

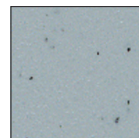

Bluestone  
BG

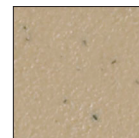

Mocha  
Stone  
MS

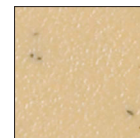

Goldstone  
GS

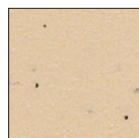

Desert Stone  
DS

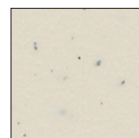

Stone  
ST

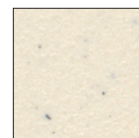

Limestone  
LS

- Due to printing limitations, colors and finishes shown cannot be guaranteed to perfectly match actual product colors.
- Color chip keychains are available for more precise color matching:  
Gloss Finishes- DG-CK-1  
Satin Finishes - SC-CK-1

#### Metal Finish (wallplate only)



Stainless  
Steel SS

When using Stainless Steel wallplates, it is recommended to order the keypad in Black (BL) or Midnight (MN).