



Publicly traded on NASDAQ Symbol: NSSC

PROGRAMMING INSTRUCTIONS



GEM-P1664 CONTROL PANEL/COMMUNICATOR

Programming the **GEM-P1664** Control Panel with the **GEM-K1VPS** Keypad and the **GEM-DK1CA** Keypad



GEM-K1VPS KEYPAD

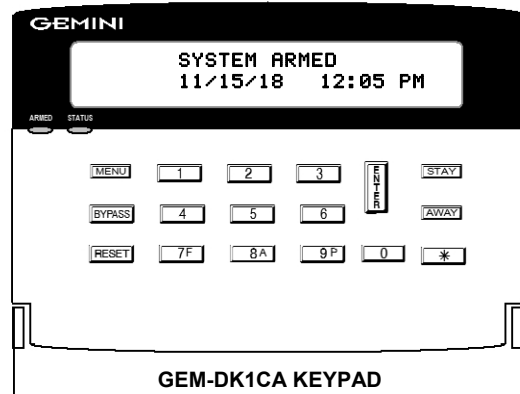

GEM-DK1CA KEYPAD

Quick Start:

1. Refer to the wiring diagram and connect the **Siren, Aux. Power, PGM Output, Remote Bus, earth ground, Zone and Telephone wiring.**
NOTE: See Installation Instructions (WI1811).

2. Connect AC power first and then the battery.

3. Access the **Easy Menu Driven Program Mode:**

Press

Default Dealer Code

☞ Press NO () until "ACTIVATE PROGRAM Y/N" appears on the programmer display.

☞ Press YES () to Enter Dealer Program Mode. Go to page 5.

**THIS MANUAL INCLUDES FEATURES WHICH ARE ONLY AVAILABLE IN
CONTROL PANEL FIRMWARE VERSION 31 OR LATER.**

IMPORTANT PROGRAMMING INFORMATION

The following System and Keypad Options **must** be programmed for proper control panel operation:

- Automatic Interior Bypass/Easy Exit (address 1424, option 1)
- Interior Normally Bypassed (address 1422, option 1)

CHANGES FROM PREVIOUS EDITION

The following changes have been made to this manual (WI1810A) since the previous edition (WI1810):

- Corrected the "AREA ARMING OPTIONS (ADDRESS 1469-1470)", page 25.
- Removed Test Timer from the Easy Menu Driven Program Mode.
- Page 6, corrected example: If 10 entered, converted to 12 automatically.
- Page 9, removed reference to "Enable Manager's Mode" from Area Options table.
- Page 19, changed "Enable Manager's Mode" to "RESERVED" (in address table 1421).
- Page 22, Touch-Tone Dialing Only enabled by default.
- Page 28, added additional information regarding the GEM-TEMP64 Temperature Sensor module.
- Pages 29-32, added "Carbon Monoxide" to Zone Options table, addresses 955, 1019, 1083, 1147, 1211, 1275, 1339 and 1403.

Warning: The use of non-NAPCO wireless devices with this control panel has not been evaluated by UL and voids the UL listing. In addition, the performance of these devices can not be guaranteed as compatible with NAPCO control panels. *For systems that include CO detectors, the system must be monitored by a central station, and at least one model GEM-RP1CAe2 or GEM-K1 series 2-line LCD keypad must be used.*



NAPCO Security Systems, Inc.
333 Bayview Avenue, Amityville, New York 11701
For Sales and Repairs, call toll free: (800) 645-9445
For direct line to Technical Service, call toll free: (800) 645-9440
Internet: <http://www.napcosecurity.com>

TABLE OF CONTENTS

SYSTEM PROGRAMMING OPTIONS	4	<i>SYSTEM DELAYS & TIMEOUTS</i>	15
INTRODUCTION	4	<i>SYSTEM OUTPUT TIMEOUTS</i>	16
DOWNLOADING FROM A COMPUTER	4	<i>DOWNLOAD/CALLBACK OPTIONS</i>	16
EASY MENU DRIVEN PROGRAM MODE	5	<i>SYSTEM OPTIONS</i>	17
Dealer Program - Preliminary Information.....	5	<i>CS RECEIVER OPTIONS</i>	20
Accessing Dealer Program Mode	5	<i>CS SUBSCRIBER ID OPTIONS</i>	21
Customizing a Default Program	5	<i>CS SYSTEM REPORTING OPTIONS</i>	22
Keypad Easy Program Menu	6	<i>CS AREA & SYSTEM REPORTING OPTIONS</i>	22
Total Number of Zones in Area 1	6	<i>CS ZONE REPORTING OPTIONS</i>	23
Panel Zone Doubling.....	6	<i>CS USER REPORTING OPTIONS</i>	24
Fire Zones in Area 1	6	<i>EZM GROUP OPTIONS</i>	25
2-Wire Fire Zones in Area 1	6	<i>AREA ARMING OPTIONS</i>	25
Local or Central Station Reporting System	6	<i>AREA BELL CONTROL OPTIONS</i>	26
Exit/Entry Zones in Area 1.....	6	<i>KEYPAD OPTIONS</i>	27
Interior Zones in Area 1.....	6	<i>TEMPERATURE DISPLAY AT KEYPAD</i>	28
24 Hour Zones in Area 1	6	<i>ZONE OPTIONS - ZONES 1 TO 16</i>	29
Chime Zones in Area 1.....	7	<i>ZONE OPTIONS - ZONES 17 TO 32</i>	30
Chime 2 Zones in Area 1.....	7	<i>ZONE OPTIONS - ZONES 33 TO 48</i>	31
Exit/Entry2 Zones in Area 1.....	7	<i>ZONE OPTIONS - ZONES 49 TO 64</i>	32
50 mS Loop Response Zones.....	7	<i>EXTERNAL RELAY CONTROL</i>	33
Aux Output Activated on Alarm Zones	7	<i>RF RECEIVER & SUPERVISORY TIMER OPTIONS</i>	36
Sensor Watch Zones.....	7	<i>CLEAR PROGRAM OPTIONS</i>	37
Keypad Sounder On Alarm Zones	7	USER PROGRAM MODE	37
Auto Bypass Re-entry Zones	7	Preliminary Information.....	37
Enable No EOLR Zones.....	7	Accessing User Program Mode	38
Enable Telco Line Fault Test?.....	7	User Codes.....	38
Enable Burg Output Chirp on KeyFob?.....	8	Zone Descriptions	39
Enable SIA CP-01 Features?	8	Date	39
Number of Keypads in Area 1	8	Time	39
Central Station Receiver 1 Telephone Number...8		KEYPAD CONFIGURATION MODE	40
Central Station Receiver 1 Account Number.....8		Keypad Installation.....	40
Central Station Receiver 1 Format.....	8	Configuring the Keypads	40
Enter User Codes	8	EASY MENU PROGRAMMING WORKSHEETS	42
RF Transmitter Points.....	9	ALPHABETICAL INDEX	46
Key Fob Transmitters as Arm/Disarm & Control Devices	9	ADDRESS NUMBER INDEX	51
Key Fob Transmitters as Zone Input Devices ..10		GEM-P1664 WIRING DIAGRAM	56
Enter Zone Descriptions.....	10		
Enter Date	10		
Enter Time	10		
Dealer Code	10		
Clear Dealer Program.....	10		
Cold Start.....	10		
DIRECT ADDRESS PROGRAM MODE	11		
Direct Address Overview.....	11		
Address Mode Displays.....	11		
Binary (Bit) Format Example.....	11		
Decimal Format Example.....	12		
Hexadecimal Format Example.....	13		
Programming Conventions Used in this Manual.....	14		

Refer to accompanying Panel Installation Instructions (WI1811) for installation information.



SYSTEM PROGRAMMING OPTIONS

INTRODUCTION

The Gemini GEM-P1664 control panel may be programmed by various means, each of which will be covered in detail in the sections that follow. Keypad displays shown are for a GEM-DK1CA or a GEM-K1VPS.

✓ **Downloading From a Computer.** This is the preferred method of programming. The panel may be downloaded from (or uploaded to) an IBM PC-compatible computer, either locally or remotely. Napco's PCD-Windows Quick-loader software features context-sensitive help screens as well as an error-checking utility that prevents programming of incompatible or conflicting data to ensure proper panel operation. **Note:** Unattended downloading from a computer is not allowed for Fire Alarm or UL installations.

✓ **Easy Menu-Driven Program (Dealer Program) Mode - Keypad Programming.** The Easy Menu-Driven Program Mode allows keypad programming of number of zones in area 1, panel zone doubling, number of fire zones (both 4-wire and 2-wire), local or Central Station reporting, number of exit/entry zones, number of interior zones, number of 24 hour zones, number of chime zones, Chime 2 zones, Exit/Entry2 zones, 50ms loop response zones (**Note:** 750mS is required for Loop Response time in UL installations), aux output activated on alarm zones, sensor watch zones, keypad sounder on alarm zones, auto bypass re-entry zones, EOLR zones, number of keypads in area 1, Central Station telephone number, Central Station account number, Central Station receiver format, User Codes, RF transmitter points, RF keyfob transmitters, zone descriptions, date/time, dealer code, Telco line fault test, Burg output chirp on keyfob, keypad time/date display, enable CP-01 programming, and clear dealer program/cold start. For new panels, a custom default program may be created at the keypad. A menu-driven utility prompts the installer to configure the system. Further detailed customization is accomplished in the Direct Address Program Mode.

✓ **Direct Address (Dealer Program) Program Mode - Keypad Programming.** The Direct Address Program Mode is an extension of the Dealer Program Mode wherein data is entered at the keypad by location. This mode is accessed from the Easy Menu Driven Program Mode by pressing the  button at any time.

✓ **User Program Mode - Keypad Programming.** The User Program Mode is intended for authorized users and is limited to keypad programming of User Codes, Time, Date and Zone Descriptions.

DOWNLOADING FROM A COMPUTER

The control-panel program may be downloaded from the computer by any of the following methods.



Local Downloading

(**Note:** This procedure should be used after installation, after peripheral devices are connected).

For direct high-speed data transfer to the control panel from a desktop computer, connect the download jack (JP2) on the panel to the LOCAL jack (J3) on the Napco PCI2000/3000 computer interface using the supplied 6-conductor cable. (Refer to PCI2000/3000 Installation Instructions WI443 for wiring diagram and procedures).

Similarly, a high-speed local download may be made in the field using a notebook or laptop computer. Connect JP2 on the control panel to a Napco PCI-MINI computer interface using the 6-conductor cable supplied. (Refer to PCI-MINI Installation Instructions WI767).

Remote Downloading

(Also see PCI2000/3000 Installation Instructions WI443). **Note:** Unattended downloading from a computer is not allowed for Fire Alarm or UL installations.

Function Mode

Start by establishing a Telco connection between the computer operator and the installer. During this procedure, voice contact will be lost, therefore both the installer and the computer operator should be familiar with the operation. When a steady high-pitched tone is heard at the site phone, access the "ACTIVATE DOWNLOAD" Function (see Keypad Programming Modes), then press the  button or the **NEXT/YES** button; the site phone will go dead.

Hang up the phone and wait for a call from the central station confirming a successful download.

Callback Method

An installed, unattended panel may be programmed or reprogrammed remotely using the Callback-Method Download feature of the PCD-Windows software. Remote downloading requires a modem compatible with the PCI2000/3000. Upon answering the call from the computer, the panel will verify the Download Security Code and, if confirmed, will establish a connection. If a Callback Number is programmed into the panel, the panel will automatically disconnect and call the computer at this number before establishing a connection.

EASY MENU DRIVEN PROGRAM MODE

DEALER PROGRAM - PRELIMINARY INFORMATION

- 👉 The Default Dealer Code is . Use this code to enter the Dealer Program Mode to program a custom Dealer Code, which replaces the Default Dealer Code. If you clear your Dealer Code, use the Default Dealer Code once again to enter programming.
- 👉 After entering codes or data, press the save button. Data will not be stored into memory unless is pressed.
- 👉 If the keypad is in the Program Mode and no activity is detected for longer than 4 minutes, a steady tone will sound.
- 👉 Silence the sounder by the button to continue, or by pressing the button to exit.
- 👉 When programming a Multiple Area System, Direct Address Programming Mode must be used to complete the program.

ACCESSING DEALER PROGRAM MODE

1. Press
↙ Dealer Code (Default = ↘

2. Press **PRIOR/NO** button until "ACTIVATE PROGRAM Y/N" appears on LCD screen.

3. Press **NEXT/YES** button to Enter Dealer Program Mode.

4. Press to Exit Dealer Program Mode when finished.

CUSTOMIZING A DEFAULT PROGRAM

For new panels, you can design a default program that will best suit your application. Using this procedure, you will configure the panel for:

- Number of Zones in Area 1
- Panel Zone Doubling
- Fire Zones in Area 1
- 2-Wire Fire Zones in Area 1
- Local or Central Station Reporting System
- Exit/Entry Zones in Area 1
- Interior Zones in Area 1
- 24 Hour Zones in Area 1
- Chime Zones in Area 1
- Chime 2 Zones in Area 1
- Exit/Entry2 Zones in Area 1
- 50mS Loop Response Zones (Note: 750mS is required for Loop Response time in UL installations).
- Aux Output Activated on Alarm Zones
- Sensor Watch Zones
- Keypad Sounder on Alarm Zones
- Auto Bypass re-entry Zones
- Enable no EOLR Zones
- Enable Telco Line Fault Test
- Enable Burg Output Chirp on Keyfob
- Enable CP-01 Programming
- Number of Keypads in Area 1
- Central Station Receiver 1 Tel. Number
- Central Station Receiver 1 Account Number
- Central Station Receiver 1 Format
- Enter User Codes
- RF Transmitter Points
 - Quick "Enroll" Method
- Key Fob Transmitters
- Enter Zone Descriptions
- Enter Date
- Enter Time
- Dealer Code

This procedure will automatically set up system keypads, EZMs, wireless transmitters, etc. After your basic default program has been loaded, you may alter it as necessary in the Direct Address Program Mode.

NEW PANELS: The custom default program may be created for new panels only. Once the panel has been programmed by any means, the number zones will be suppressed and cannot be changed. Should it be necessary to create a new custom default program, (a) from the Dealer Program Mode, press the button to enter the Direct Address Program Mode; (b) access Location 2285 (Clear Program); (c) press the button and start over.

Keypad Easy Program Menu

To create a custom program using the GEM-DK1CA or a GEM-K1VPS keypad, simply answer the following questions and record your information on the *Easy Menu Programming Worksheet*. In each of the following steps, press **[MENU]** to set cursor, the NEXT/YES button to go forwards, the PRIOR/NO button to go backwards, **[SAVE]** to save and **[RESET]** twice to exit at any time.

```
#of Zns in Area1
Enter # Zones XX
```

(Direct Entry)

Total Number of Zones in Area 1 (New Program Only)

- Enter the total number of zones to be programmed for Area 1.
- Valid entries are from 01 to 64. Directly enter the total number of zones, including leading zeros.
- The system is based on groups of 4 zones each (after the first 8 zones), and will automatically round up to the next group of 4. For example, if you enter 10, it will automatically convert this to 12 zones. Press **[SAVE]** to save. Press the NEXT/YES button to proceed.

```
EZ Zone Doubling
Enabled? Y/N
```

(Press YES or NO)

Panel Zone Doubling (New Program Only)

- To double the number of hardwired panel zones from 8 to 16, press YES.
- If Panel Zone doubling is not desired, press the PRIOR/NO button.
- The 16 zones will remain EOL terminated zones, requiring Normally Closed devices only.
- Refer to Wiring Diagram and Installation Instructions for wiring instructions

```
Fire Zones
Enter Zone # **
```

(Direct Entry)

Fire Zones in Area 1 (New Program Only)

- Enter the zone number of any Fire Zones (including 2-wire, 4-wire or wireless).
- Valid entries are from 01 to 64.
- Directly enter each zone number, including leading zeros, and press **[SAVE]** to save, and then repeat for any additional zone(s). Press the NEXT/YES button to proceed.

```
2-Wire Fire Zns
Enter Zone # **
```

(Direct Entry)

2-Wire Fire Zones in Area 1 (New Program Only)

- Enter the zone number of any Fire Zone (from previous question) to be used with 2-wire smoke detectors.
- Valid entries are 07 and 08. Directly enter each zone number, including leading zeros.
- Press **[SAVE]** to save, and repeat for any additional zone(s); press NEXT/YES to proceed.

NOTE: Only zones which have been designated as Fire Zones can be programmed as 2 Wire Fire zones. JP3 must be set to "2-WF" position for 2-wire fire. (refer to Installation Instructions).

```
Report All Zones
To Central? Y/N
```

(Press YES or NO)

Local or Central Station Reporting System (New Program Only)

Press the NEXT/YES button for all zones to report; press the PRIOR/NO button for local system

```
Exit/Entry Zones
Enter Zone # XX
```

(Direct Entry)

Exit/Entry Zones in Area 1 (New Program Only)

- Enter the zone numbers of zones to be used as Exit/Entry zones.
- Valid entries are from 01 to 64. Directly enter each zone number, including leading zeros.
- Press **[SAVE]** to save and repeat for any additional zone(s); press the NEXT/YES button to proceed.

NOTE: Exit/Entry Entry time of 30 seconds will automatically be programmed.

```
Interior Zones
Enter Zone # XX
```

(Direct Entry)

Interior Zones in Area 1 (New Program Only)

- Enter the zone numbers to be used as Interior Zones.
- Valid entries are from 01 to 64. Directly enter each zone number, including leading zeros.
- Press **[SAVE]** to save and then repeat for any additional zone(s).
- Press the NEXT/YES button to proceed.
- All Interior zones will also be automatically programmed as "Exit/Entry Follower" and as "Power Up Delay" zones.

```
24 Hour Zones
Enter Zone # **
```

(Direct Entry)

24 Hour Zones in Area 1 (New Program Only)

- Enter the zone numbers of zones to be used as 24 Hour zones.
- Valid entries are from 01 to 64. Directly enter each zone number, including leading zeros.
- Press **[SAVE]** to save and repeat for any additional zone(s); press the NEXT/YES button to proceed.

NOTE: 24 Hour Zones will automatically be programmed as audible (Burg Output).

```
Chime Zones
Enter Zone # **
```

(Direct Entry)

Chime Zones in Area 1 (New Program Only)

- Enter the zone numbers which are to be used as Chime Zones.
- Valid entries are from 01 to 64. Directly enter each zone number, including leading zeros.
- Press  to save, then repeat for any additional zone(s), press the NEXT/YES button to proceed.

NOTE: A chime time of 2 seconds will be automatically programmed.

```
Chime 2 Zones
Enter Zone # **
```

(Direct Entry)

Chime 2 Zones in Area 1 (New Program Only)

- Enter the zone numbers which are to be used as Chime 2 Zones.
- Valid entries are from 01 to 64. Directly enter each zone number, including leading zeros.
- Press  to save, then repeat for any additional zone(s), Press the NEXT/YES button to proceed.

NOTE: A chime time of 2 seconds will be automatically programmed.

Chime 2 zones give a distinct pulsating tone when zone is faulted.

```
Exit/Entry2 Zones
Enter Zone # **
```

(Direct Entry)

Exit/Entry2 Zones in Area 1 (New Program Only)

- Enter the zone numbers of zones to be used as Exit/Entry zones.
- Valid entries are from 01 to 64. Directly enter each zone number, including leading zeros.
- Press  to save and repeat for any additional zone(s); press the NEXT/YES button to proceed.

NOTE: An Exit/Entry 2 Entry Time of 30 seconds will automatically be programmed.

```
50mS Loop Zones
Enter Zone # **
```

(Direct Entry)

50 mS Loop Response Zones (New Program Only) Note: 750mS is required for Loop Response time in UL installations.

- Enter the zone numbers of zones to be have a 50mS loop response.
- Valid entries are from 01 to 08. Directly enter each zone number, including leading zeros.
- Press  to save, then repeat for any additional zone(s), Press the NEXT/YES button to proceed.

Note: Only panel zones 01-08 can be programmed for Quick Loop Response. All other zones can be programmed via their respective EZM's (hardware). Time can also be adjusted via address 2280.

```
Aux Output Zones
Enter Zone # **
```

(Direct Entry)

Aux Output Activated on Alarm Zones (New Program Only)

- Enter the zone numbers of zones to activate the PGM2 upon alarm.
- Valid entries are from 01 to 64. Directly enter each zone number, including leading zeros.
- Press  to save, then repeat for any additional zone(s), Press the NEXT/YES button to proceed.

NOTE: A PGM2 Timeout of 15 minutes will automatically be programmed.

```
Sensor Watch Zns
Enter Zone # **
```

(Direct Entry)

Sensor Watch Zones (New Program Only)

- Enter the zone numbers of zones to be Sensor Watch zones.
- Valid entries are from 01 to 64. Directly enter each zone number, including leading zeros.
- Press  to save, then repeat for any additional zone(s), Press the NEXT/YES button to proceed.

NOTE: A Sensor Watch Time of 24 hours will automatically be programmed.

```
KP Sndr Alrm Zns
Enter Zone # **
```

(Direct Entry)

Keypad Sounder On Alarm Zones (New Program Only)

- Enter the zone numbers of all zones to activate the Keypad Sounder upon alarm.
- Valid entries are from 01 to 64. Directly enter each zone number, including leading zeros.
- Press  to save, then repeat for any additional zone(s), Press the NEXT/YES button to proceed.

```
Auto Byp REnt Zn
Enter Zone # **
```

(Direct Entry)

Auto Bypass Re-entry Zones (New Program Only) (Not Evaluated by UL)

- Enter the zone numbers of zones to be Auto Bypass Re-entry zones.
- Valid entries are from 01 to 64. Directly enter each zone number, including leading zeros.
- Press  to save, then repeat for any additional zone(s), Press the NEXT/YES button to proceed.
- Auto Bypass Re-entry Zones allow the system to be armed with the zone faulted but come back into the system (armed) when the zone is subsequently closed.

```
Enable No EOLR
Zones Y/N
```

(Press YES or NO)

Enable No EOLR Zones (New Program Only)

- Press YES to program all zones except 24 Hr & fire zones for No End Of Line Resistor. Press NO to continue. Do NOT program this feature for UL installations.

```
Enable Telco
Line Test? Y/N
```

(Press YES or NO)

Enable Telco Line Fault Test?

- Press YES to enable Telco Line Fault Test.
- Press NO to continue. **NOTE: If enabled, a Telco Line Fault Test Delay of 60 sec. will automatically be programmed.**



Enable Burg Out Chirp? Y/N

(Press YES or NO)

Enable SIA CP-01? Y/N

(Press YES or NO)

Area 1 Keypads Enter # KPs 01

(Direct Entry)

Central Phone #

(Direct Entry)

Central Station Account # (____)

(Direct Entry)

See WI for Info Rcvr Format (0)

(Direct Entry)

Enter user code-> U01 123 - 9-

User# User Code Area 1 Area 2

Enable Burg Output Chirp on KeyFob?

- Press the NEXT/YES button to enable Burg Output Chirp on KeyFob Arm / Disarm.
- Press the PRIOR/NO button to continue.

NOTE: The Burg Output will chirp once on Keyfob Arm and twice on Keyfob Disarm.

Enable SIA CP-01 Features?

- Press the NEXT/YES button to enable.
- Press the PRIOR/NO button to continue.

The SIA CP-01 Features are designed to reduce the incidence of false alarms. **NOTE:** Do not enable unless reporting, otherwise system trouble *Fail to Communicate* may occur.

Number of Keypads in Area 1

- Enter the total number of Keypads to be installed in Area 1.
- Valid entries are from 01 to 07. Directly enter the number of keypads, including leading zeros. Press to save. Press the NEXT/YES button to proceed.

NOTE: Area 2-4 keypads must be assigned in Direct Address Programming. See Keypad Options.

Central Station Receiver 1 Telephone Number

- Enter telephone number of up to 16 digits.
- Press through for digits 1-9; for a zero and for a blank (*).
- Press through for letters B-F, respectively.
- Pre-Dial Delay = "D" (); Dial-Tone Detection = "E" (.
- Press to save and press the NEXT/YES button to proceed.

NOTE: Central Station Receiver 2 and 3 Telephone Numbers must be entered in Direct Address Programming. See CS Receiver Options.

Central Station Receiver 1 Account Number

- Enter an account number of up to four digits.
- Press through for digits 0-9, and for a blank (*).
- Press to save and press the NEXT/YES button to proceed.

NOTE: Central Station Receiver 2 and 3 Account Numbers must be entered in Direct Address Programming. See CS Reporting Options.

Central Station Receiver 1 Format

- From the table at the right enter the receiver format.
- Press through , and for blank (*).
- Press through for letters B-E.
- Press to save; press the NEXT/YES button to proceed.

DATA ENTRY	CS RECEIVER 1 FORMAT
• (blank)	Ademco Slow, Silent Knight Slow
2	Radionics Fast
3	Silent Knight Fast
4	Radionics, DCI, Franklin Slow
5	Universal High Speed
B	SIA
C	Ademco Point ID
E	Pager

Enter User Codes (Press to set cursor.)

For default program, enter up to 64 User Codes, with Area 1, 2, 3 & 4 Options.

- Press the () button once to set the cursor to the User Code.
- Press through to enter a code from 3 to 6 digits, leave blank (*) any trailing boxes.
- Press to set the cursor to the Area 1 Options Level. Refer to the table below for available options. For Area 2 Options, press the button once again. For Area 3 & 4 Options, press a third and fourth time.

- If "Enable Global Ambush Code" (Address 1422) is enabled and "Global Ambush Code" (Address 2045) is **not** left blank (*), *do not* program the first two digits of ANY User Code the same as the "Global Ambush Code". See Address 2045 further in this manual for more information.
- Press to save. **Note:** Duplicate User Codes are not allowed; therefore a duplicate Code entered in the LCD Window will erase when is pressed. To proceed to the next User Code, press to set the cursor to the User Number and change it using the number buttons. Press the NEXT/YES button to proceed.

USER OPTIONS				
USER CODE (UP TO 6 DIGITS)	AREA 1 OPTIONS	AREA 2 OPTIONS	AREA 3 OPTIONS	AREA 4 OPTIONS

USER AREA OPTIONS		
DATA ENTRIES		OPTION ENABLED
L	R	
blank(*)	blank(*)	Disabled
blank(*)	1	Arm/Disarm
blank(*)	2	Arm Only
blank(*)	3	Service
blank(*)	4	Access
blank(*)	5	Ambush
blank(*)	Add 8	* User Program
4	blank(*)	Bypass Enable

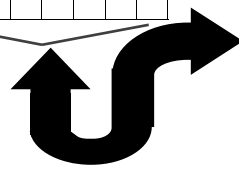

Example: Program a code of "2222" for user 02, with area 1 options of "Arm/Disarm" and "User Program". Enter "2222" for a user code, "*" (blank) "9" for area 1 options and "*" (blank) "*" (blank)" for area 2 options.

AREA OPTIONS	EXPLANATION
Disabled	User Code not active in this area.
Arm/Disarm	Allows User Code to arm/disarm this area.
Arm Only	Prevents User Code from disarming this area.
Service	A Service Code has restricted arm/disarm rights; if an area is armed with a Service Code, a "MONITOR ON" appears on the keypad and the area can be disarmed with any valid User Code, including a Service Code. If the area is armed with OTHER than a Service Code, it CANNOT be disarmed with a Service Code. This is typically used to allow tradesmen access to premises under control of the owner.
Ambush	There are two types of Ambush Codes: (1) A 2-digit code (prefix) that is entered immediately prior to (and as part of) the regular User Code and (2) A separate and unique User Code. Disarming with an Ambush Code will cause a silent report to be sent to a central station. Thus, should a user be forced to disarm, he can silently signal an emergency while appearing to be merely disarming the system.
Access	This is normally used to activate a door strike while an area is disarmed. Also program "Access Control on PGM2. Output" (Address 0719) and "PGM2 Output Access Control Timeout" (Address 0711).
* User Program	User Program Option is enabled. To enable User Program Option for any user, add 8 to the data entry for Area Option (see example). Then, User Programming can be performed at any Keypad by a user code with user program enabled.
Bypass Enable	Security Bypass-Bypass is enabled only with a security code.

Related User Options: "Enable Global Ambush Code" (Address 1422) and "Global Ambush Code" (Address 2045).

CHANGING OR CANCELING A CODE: To change any code, merely program over the existing code as described above and press ENTER to save. Similarly, to cancel a code, blank out each number of the code and press ENTER to save.

ZN#	XMIT# + CS	P
Zn01-	000000:	0-0

Zone # Xmitter Check Point
Mapped to ID Sum #

RF Transmitter Points (Press **MENU** to set cursor.)

For each transmitter enter: (For wireless systems only. Also see Quick Method, which follows)

- The **zone number** (01–64) to which the transmitter will be mapped.
- The **6-digit RF ID #** and **1-digit checksum number** printed on the transmitter and box,
- The **point number** (1–2); enter "9" for *unsupervised* (all points).
- Press **ENTER** to save and NEXT/YES button to proceed when all transmitters have been entered.

NOTE: When programming the ID Code number, "0" through "9" = **0** through **9P**; A = ***** **0**; B = ***** **1**;

C = ***** **2**; D = ***** **3**; E = ***** **4** and "F" = ***** **5**.

ZN#	XMIT# + CS	P
Zn01-	000000:	0-0

Quick "Enroll" Method: If a receiver is already installed in the panel, transmitter wireless points can be programmed automatically ("enrolled") using the following procedure. **NOTE:** The transmitter point will be enrolled only if the signal strength is 3 or greater.

1. Enter the zone number to which the transmitter point will be mapped.
2. Press **BYPASS** to enter the Enroll Mode. The red and green LEDs on the keypad will flash and the window will display as shown at left.
3. Open the loop of the point that is to be programmed (GEM-TRANS2 only).
4. Install the transmitter battery. The keypad will beep to indicate that the point has been successfully enrolled. Multi-point transmitters can be mapped to successive zones simultaneously.

Example. A 2-point transmitter has the RF ID number 287613:1. Map point 1 to Zone 6 and point 2 to Zone 9.

1. Enter the Enroll mode as described above.
2. Enter Zone "06".
3. Open point-1 loop.
4. Install the battery. The keypad will beep once to indicate that one point has been programmed. (Transmitter 287613:1, point 1 will be mapped to Zone 6).
5. Enter Zone "09".
6. Close point-1 loop and open point-2 loop.
7. Remove the transmitter battery, then re-install it. The keypad will beep once to indicate that one point has been programmed. (Transmitter 287613:1, point 2 is mapped to Zone 9).

KEY FOB ZONE ASSIGNMENT: Key fobs can also be assigned to zones to allow multiple wireless panic buttons on one alarm system, each reporting to a central station, a pager or having a description on the keypad that describes the person holding the key fob, the location where the person holding the key fob is stationed, or the special purpose of the key fob button being depressed. See the next page on Key Fob Transmitters as Zone Input Devices.

KF	A	XMIT# + CS	OP
01-	0	000000:	0 00

KF Area Xmitter Check Aux
ID Sum 1&2

Key Fob Transmitters as Arm/Disarm & Control Devices (Press **MENU** to set cursor).

Key fobs can be programmed as "Arm/Disarm" devices using their On/Off buttons (refer to WI752). For each Key Fob Transmitter, enter:

- The **Key Fob Transmitter number** (01–8).
- The **area number** to which transmitter is assigned (0 to disable keyfob, 1 through 4).
- The **6-digit RF ID #** and **1-digit checksum number** printed on the transmitter and box,
- The **Aux 1 Option** (see key fob aux 1 & aux 2 options).
- The **Aux 2 Option** (see key fob aux 1 & aux 2 options).

• Press **ENTER** to save and NEXT/YES button to proceed when all key fobs have been entered.

NOTE: When programming the ID Code number, "0" through "9" = **0** through **9P**; A = ***** **0**; B = ***** **1**;



Key Fob Transmitters as Zone Input Devices

(Refer to display above: press the AWAY button to go backwards).

Each of the 4 key fob buttons can be assigned to a zone. For example, On button = point 1; Off button = point 2; A1 = point 3; A2 = point 4. Up to 64 key fobs (using 1 button) or 32 key fobs (using 2 buttons) or 16 key fobs (using all 4 buttons) or any combination up to a maximum of 64 controlled zones can be assigned, providing multiple wireless panic buttons on a system, each reporting to a Central Station or a pager and/or annunciating on a keypad the key fob zone number with a description. To assign a key fob to a zone: program the key fob as you would a transmitter, entering the key fob's ID code, check sum and point number at the appropriate zone. The "Quick Method" is not allowed. The zone may be hardwired to an electrical sensor as well as assigned to a key fob (either one will activate the zone alarm output). **NOTE:** If assigning a key fob to a zone, the "ON/OFF" buttons on the key fob will no longer arm/disarm the system. The key fob is converted to a "panic only" device.

DATA ENTRY	AUX 1/AUX 2 OPTIONS
0	None
1	Relay Group 1 Toggle
2	Relay Group 2 Toggle
9	Keypad Panic
A	Keypad Aux.
B	Instant
C	PGM2 Output Toggle
D	Access on PGM2 Output
E	Arm STAY
F	Interior Button



(Direct Entry)

Enter Zone Descriptions

- For each zone, enter a description of up to two lines. Press to save each description.
- See page 41 for instructions for entering characters and numbers for the zone descriptions.
- To proceed to the next description, place the cursor under the Zone Number (e.g. "1") and

press the number that corresponds to the zone. Program new description as above. Zone Descriptions can be entered through the keypad or by using the Napco Quickloader Software. See *Easy Menu Programming Worksheet* for available zone description characters.



(Direct Entry)

Enter Date (Press to set cursor).

- Enter the current date in the format MM/DD/YY. (MM = month, DD = day and YY = year.
- Press to save. Press the NEXT/YES button to proceed.



(Direct Entry)

Enter Time (Press to set cursor.)

- Enter the current time in format HH:MMA/P, where HH=hours (01–12); MM=minutes (00–59).
- Select AM or PM by pressing any number button.
- Press to save. Press the NEXT/YES button to proceed.



Dealer Code

- Directly enter the Dealer Code (default = 456789), using through buttons.
- Press to save. Re-enter the Dealer Code to verify the previous code. Press to save.
- Press the NEXT/YES button to proceed.



EXIT DEALER PROGRAM MODE: This completes the custom default program. Press to enter the Direct Address Program Mode for further programming or press once again to end all programming and resume normal keypad operation.

CLEAR PROGRAM: Should it be necessary to create a new custom default program, (a) from the Dealer Program Mode, press to enter the Address Program Mode; (b) access Location 2285 (Clear Program) or 2286 (Cold Start); (c) press and then (d) press to exit the Dealer Program Mode. A "SYSTEM TROUBLE/E09-00 SERVICE" will occur. Press to silence the keypad.

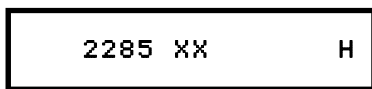

Clear Dealer Program (Erases Dealer Program)

Use this feature to erase the Panel Program, while maintaining Scheduled Data and Zone Descriptions. Access address 2285 and press . Data entry is not allowed. **NOTE:** Enter Easy Menu Driven Program Mode to reprogram system.

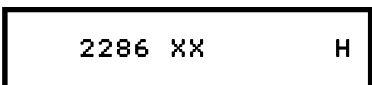

Cold Start (Erases Entire Program)

This erases all programmed data (Dealer Program, Zone Description Data and Schedules). Access address 2286 and press . Data entry is not allowed. **NOTE:** Some features

DIRECT ADDRESS PROGRAM MODE

DIRECT ADDRESS OVERVIEW

Direct Address Programming allows you to go directly to the address locations (up to 2287) and change the data entries manually in order to customize your control panel options. Whereas the Easy Menu Program Mode guides you through limited selections to get you started, **Direct Address Program Mode** allows you to change all options directly. It consists of up to 2287 address locations each with data entry locations as shown in the following diagram (below left). The data entry location accepts data in one of three formats: Binary, Decimal and Hexadecimal (explained below in "**Address Mode Displays**"). The following diagram (below right) illustrates a *Decimal* format data entry location using a keypad.

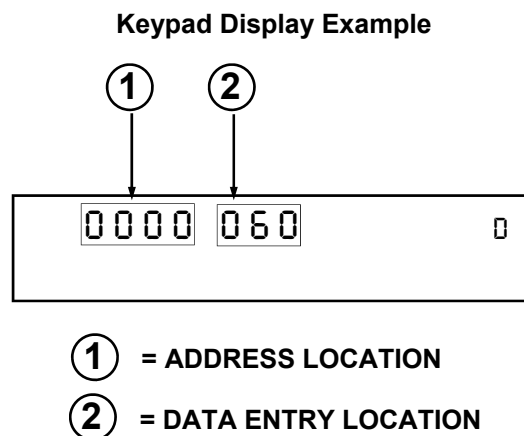
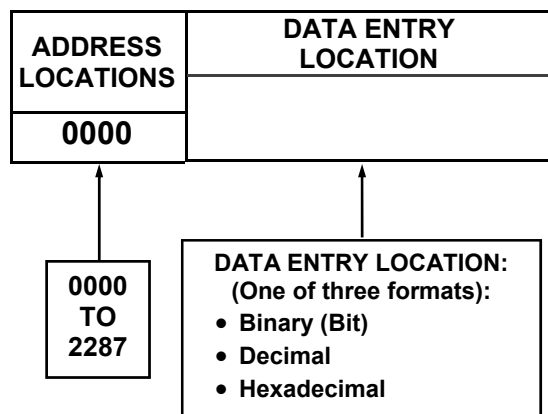

ADDRESS MODE DISPLAYS

There are three types of address displays when programming in Direct Entry Program Mode, as follows:

A) Binary (Bit) Format Example

Settings (such as Zone Features) display and accept data in "number" format. For example, Zone Features are turned on by the pressing of keypad buttons 1 through 8, with the activated Zone(s) displaying the corresponding decimal digit (replacing deactivated zones which are signified by dashes).

EXAMPLE: BIT Format with the keypad: Program Zones 2, 4, 5 and 7 as *Exit/Entry Follower Zones*.

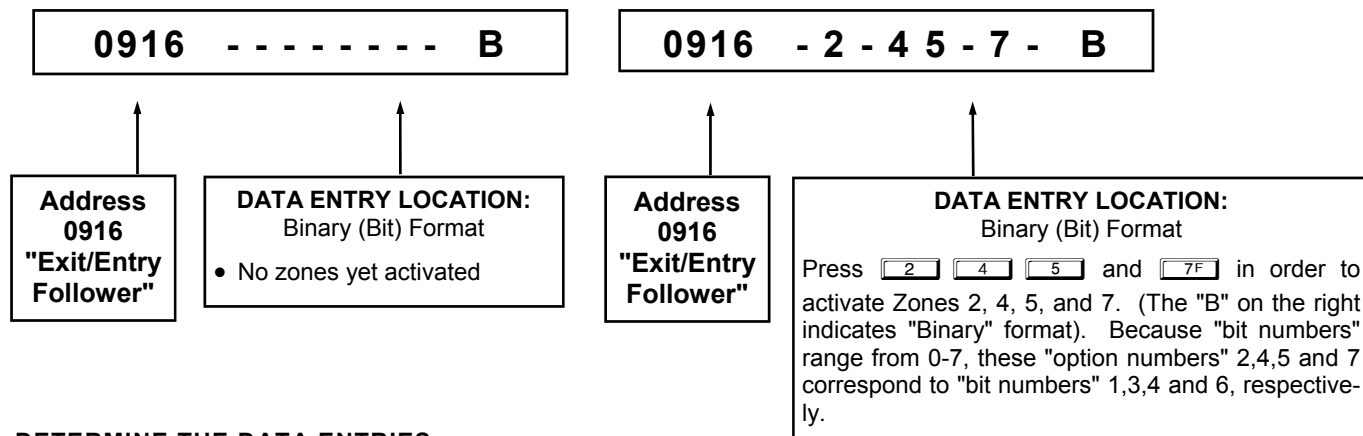

DETERMINE THE DATA ENTRIES

1. Referring to ZONE FEATURES in the Programming Worksheets that follow, the Exit/Entry Follower for Zones 1 through 8 are located at address 0916.

ZONE FEATURES	ADDR	ZONES 1 → 8								ADDR	ZONES 9 → 16							
		Z1	Z2	Z3	Z4	Z5	Z6	Z7	Z8		Z9	Z10	Z11	Z12	Z13	Z14	Z15	Z16
		1	2	3	4	5	6	7	8		1	2	3	4	5	6	7	8
Exit/Entry Follower	0916						6	7	8	0911								

PROGRAM THE DATA ENTRIES

1. Enter the panel's Dealer Security Code, then press **[MENU]**.
2. Answer NO to all questions until "ACTIVATE PROGRAM Y/N" is displayed; then press YES. **NOTE:** If you pass "ACTIVATE PROGRAM", scroll backward using **[BYPASS]**.
3. Press **[RESET]** to enter the Address Program Mode. Address "0000" will display.
4. Press **[0]** **[9P]** **[1]** **[6]** to access Address 0916. *The existing data will display and the cursor will advance to the data field.*
5. Press **[6]** **[7F]** **[8A]**. The numbers 6,7 and 8 will appear on the keypad display indicating the zones activated.
6. Press **[ENTER]** to save. Address 0916 is now programmed with "6,7,8".
7. Press **[MENU]** and enter another 4-digit address to continue programming --or-- press **[RESET]** to exit and resume normal keypad operation.

B) Decimal Format Example

Settings (such as Entry and Exit Delay) display and accept data in decimal format, as a 3 digit number. Data is entered directly, by pressing keys 0 – 9, with the cursor automatically moving to the right upon each key press.

EXAMPLE: DECIMAL Format with the keypad: Program *Abort Delay* to be 15 seconds.

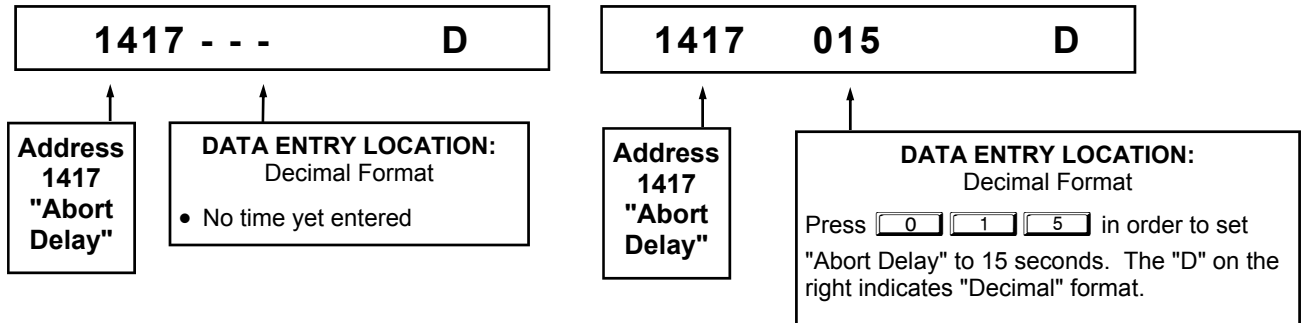

DETERMINE THE DATA ENTRIES

1. Referring to SYSTEM DELAYS & TIMEOUTS in the Programming Worksheets that follow, the Abort Delay is located at address 1417:

ABORT DELAY (sec.)	ADDRESS 1417		

[Default = 0 sec. = blank (•)]

PROGRAM THE DATA ENTRIES

1. Enter the panel's Dealer Security Code, then press **[MENU]**.
2. Answer NO to all questions until "ACTIVATE PROGRAM Y/N" is displayed; then press YES. **NOTE:** If you pass "ACTIVATE PROGRAM", scroll backward using **[BYPASS]**.
3. Press **[RESET]** to enter the Address Program Mode. Address "0000" will display.
4. Press **[1]** **[4]** **[1]** **[7F]** to access Address 1417. *The existing data will display and the cursor will advance to the data field.*

vance to the data field.

- Press . The numbers 015 will appear on the keypad display indicating the number of seconds entered.
- Press to save. Address 1417 is now programmed with a 15-second Abort Delay.
- Press and enter another 4-digit address to continue programming--or--press to exit and resume normal keypad operation.

C) Hexadecimal Format Example

Data such as Report Codes displays and accepts data by means of a Hexadecimal display. Data is entered directly, by pressing keys 1 – 9, for zero, and through for hex B through F (11-15), with the cursor automatically moving to the right upon key press. See table below.

HEXADECIMAL ENTRIES					
ENTRY TOTAL	PRESS	KEYPAD DISPLAYS	ENTRY TOTAL	PRESS	KEYPAD DISPLAYS
blank	<input type="button" value="0"/>	•	8	<input type="button" value="8"/> <input type="button" value="A"/>	8
1	<input type="button" value="1"/>	1	9	<input type="button" value="9"/> <input type="button" value="P"/>	9
2	<input type="button" value="2"/>	2	10	<input type="button" value="*"/> <input type="button" value="0"/>	0
3	<input type="button" value="3"/>	3	11	<input type="button" value="*"/> <input type="button" value="1"/>	B
4	<input type="button" value="4"/>	4	12	<input type="button" value="*"/> <input type="button" value="2"/>	C
5	<input type="button" value="5"/>	5	13	<input type="button" value="*"/> <input type="button" value="3"/>	D
6	<input type="button" value="6"/>	6	14	<input type="button" value="*"/> <input type="button" value="4"/>	E
7	<input type="button" value="7"/> <input type="button" value="F"/>	7	15	<input type="button" value="*"/> <input type="button" value="5"/>	F

EXAMPLE: HEXADECIMAL Format with the keypad: Program *Chime Timeout* to be 2 seconds.

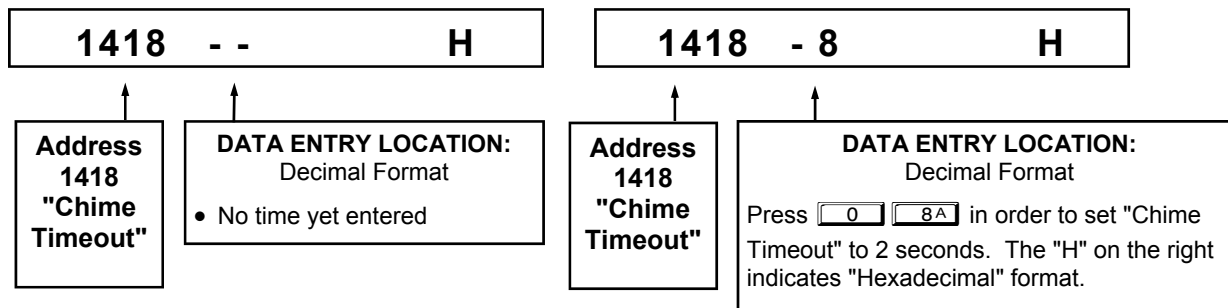

DETERMINE THE DATA ENTRIES

- Referring to SYSTEM DELAYS & TIMEOUTS in the Programming Worksheets that follow, the Chime Timeout is located at address 1418. In the "Chime Timeout Options" table, the data entries needed to assign a timeout of 2 seconds are "blank" and "8".

CHIME TIMEOUT ($\frac{1}{4}$ sec.)	ADDRESS 1418

[Default = 2 $\frac{1}{4}$ sec. = $\frac{1}{2}$ sec.]

CHIME TIMEOUT OPTIONS		
DATA ENTRIES		TIMEOUT
LEFT	RIGHT	
blank (*)	blank (*)	0 x $\frac{1}{4}$ sec. = 0 sec.
blank (*)	2	2 x $\frac{1}{4}$ sec. = $\frac{1}{2}$ sec.
blank (*)	3	3 x $\frac{1}{4}$ sec. = $\frac{3}{4}$ sec.
blank (*)	4	4 x $\frac{1}{4}$ sec. = 1 sec.
blank (*)	5	5 x $\frac{1}{4}$ sec. = 1.25 sec.
blank (*)	6	6 x $\frac{1}{4}$ sec. = 1.5 sec.
blank (*)	7	7 x $\frac{1}{4}$ sec. = 1.75 sec.
blank (*)	8	8 x $\frac{1}{4}$ sec. = 2 sec.
F	F	255 x $\frac{1}{4}$ sec. = 63.25

← 2 seconds

PROGRAM THE DATA ENTRIES

1. Enter the panel's Dealer Security Code, then press **MENU**.
2. Answer NO to all questions until "ACTIVATE PROGRAM Y/N" is displayed; then press YES. **NOTE:** If you pass "ACTIVATE PROGRAM", scroll backward using **BYPASS**.
3. Press **RESET** to enter the Address Program Mode. Address "0000" will display.
4. Press **1** **4** **1** **8A** to access Address 1418. *The existing data will display and the cursor will advance to the data field.*
5. Since you wish the timeout to be for 2 seconds (and 8 multiplied by ¼ second equals 2 seconds), press **0** **8A**. The numbers 08 will appear on the keypad display indicating the number of seconds entered.
6. Press **SAVE** to save. Address 1418 is now programmed with a 2-second chime.
7. Press **MENU** and enter another 4-digit address to continue programming --or-- press **RESET** to exit and resume normal keypad operation.

PROGRAMMING CONVENTIONS USED IN THIS MANUAL

The Keypad Programming Worksheets in the back are provided as an address-programming reference to help the installer modify his custom default program or to make minor field alterations to an existing panel program. It is recommended that the panel be uploaded to NAPCO's PCD-Windows software following any keypad programming and that the PCD-Windows's error-check feature be utilized to reduce the possibility of programming omissions or conflicts.

Keep the Keypad Programming Worksheets on file for future reference.

General Programming Steps

1. Contact the central station to ascertain receiver format, data format, event codes, subscriber numbers and telephone number(s).
2. Select the desired features by circling  the respective "address" boxes. Refer to the Programming Options and Worksheets for guidance in selecting the "data" to be entered into those boxes.
3. Program the data entered in the boxes on the worksheets into the respective addresses. The display will show the entry numerically, but if hexadecimal format will display "0" for the number 10, and letters "B", "C", "D", "E", and "F" for the numbers 11 through 15, respectively. To program a 10, press ***** **0**. To program 11 through 15, press ***** **1** through ***** **5**, respectively.

The displays will appear after a brief delay.

- Use **MENU** to toggle the cursor between the 4-digit address field and the data entry locations.
- Enter the address directly using the number buttons.
- The contents of the address will be read automatically. The cursor will advance to the data field. Enter the required data directly using the number buttons.
- IMPORTANT:** Press **SAVE** to save the contents of each address.

EXIT DIRECT ADDRESS PROGRAM MODE: When done, press **RESET** to exit and resume normal keypad operation.

SYSTEM DELAYS & TIMEOUTS (ADDRESS 0000-0002, 1413, 1417, 2050 & 2055)

EXIT DELAY (sec.)	ADDRESS 0000		

[Default = 060]

ENTRY DELAY 1 (sec.)	ADDRESS 0001		

[Default = 030]

ENTRY DELAY 2 (sec.)	ADDRESS 0002		

[Default = 030]

PGM2 Output Access Cntrl Timeout (sec.)	ADDRESS 1413		

[Default = 0 sec. = blank (*)]

ABORT DELAY (sec.)	ADDRESS 1417		

[Default = 030]

Select delay/timeout (0-255 sec.).

EXIT/ENTRY DELAYS: Apply only to zones programmed with the following options "Exit/Entry 1, Exit/Entry 2, Exit/Entry Follower". For UL Installations, the maximum exit delay is 60 seconds and the maximum entry delay is 45 seconds. **NOTE:** Sensor Watch Time Options are similar to above, except in hours.

Press to save.

Sensor Watch Time (Hrs.)	ADDRESS 2050		

[Default = 024]

Report Cancel Window (min.)	ADDRESS 2055		

[Default = 0 min. = blank (*)]

WARNING: Timers have uncertainty of +/-1 sec, so a "time" of 1 second may actually timeout IMMEDIATELY.

SYSTEM DELAYS & TIMEOUTS (ADDRESS 1418-1419)

CHIME TIME (¼sec.)	ADDRESS 1418		

[Default = 008 x ¼ sec. = 2 sec.]

AC Fail Report Delay (min.)	ADDRESS 1419		

[Default = 060]

DEFAULTS: The defaults shown on this page and on the following pages are automatically set after exiting the Easy Menu Driven Mode.

1. Enter delay/timeout in corresponding address locations above.

Note: All entries for address 1418 are in quarter seconds (.25 seconds). Therefore, the default of 008 results in a 2 second timeout.

2. Press to save.

SYSTEM OUTPUT TIMEOUTS (ADDRESS 1412 & 1414-1416)

PGM2 Output	ADDRESS 1412		
Timeout (min.)			

[Default = 0 min. = blank (*)]

Alarm Output	ADDRESS 1414		
Timeout (min.)			

[Default = 015]

Pulse Alarm Output	ADDRESS 1415		
Timeout (min.)			

[Default = 015]

PGM1 Output	ADDRESS 1416		
Timeout (min.)			

[Default = 0 min. = blank (*)]

DATA ENTRIES	DELAY/TIMEOUT
blank (*)	0 min.
001	1 min.
002	2 min.
003	3 min.
004	4 min.
005	5 min.
006	6 min.
016	16 min.
↓	↓
255	255 min.

1. Select delay/timeout (0-255 min.) from the table shown.
2. Enter in corresponding address locations above.
3. Press to save.

OUTPUT TIMEOUTS: If a timeout of "0 min." is selected, then the output will remain active (ON) until the system is reset or disarmed. For UL Residential Installations, the minimum timeout is 4 minutes. Not UL listed for Commercial Installations.

DOWNLOAD/CALLBACK OPTIONS (ADDRESS 2059 & 0526-0545)

No. Rings Before Pickup	ADDRESS 2059		
Pickup			

[Default = 015]

NUMBER OF RINGS BEFORE PICKUP: Enter the number of rings before automatic pickup by the control panel when downloading from a computer (see Glossary at the back for more information).

1. Enter digit only.
2. Valid entries are: 003-015. **NOTE:** Default is 15 Rings.
3. Press to save.

Callback Telephone Number (Digits 1-20)	ADDRESS 0526-0545 (RIGHT DIGITS 1-20)																				
	0526	0527	0528	0529	0530	0531	0532	0533	0534	0535	0536	0537	0538	0539	0540	0541	0542	0543	0544	0545	
(Digits 1-20)																					

[Default = blank (*) for all digits 1-20]

CALLBACK TELEPHONE NUMBER: Enter telephone number to be used when downloading from a computer (see Glossary at the back for more information).

1. Enter digit only (right nibble).
2. Enter up to 20 digits from left to right. **NOTE:** Leave trailing boxes blank (*).
3. Valid entries are: 1-9, B = , C = , D = 3 sec. pause, E = Wait for dial tone, F = ignore location.
4. Press to save.

PAGER FORMAT OPTIONS (ADDRESS 0546 & 0547)

Leading Digits for Pager Format (1st Digit)	ADDRESS 0546
(1st Digit)	

Leading Digits for Pager Format (2nd Digit)	ADDRESS 0547
(2nd Digit)	

[Default = blank (*) blank (*)]

LEADING DIGITS FOR PAGER FORMAT: In Pager Format reporting, the message typically begins with "00". However, for some pager services, this will cause the Pager's Voice Mail feature to activate. This option allows you to program these digits to any number desired. A typical Pager report is "003 22 1234", where 3 is the Event, 22 is the zone, and 1234 is the Subscriber ID number. For example, if the Leading Digits are programmed as "98", the Pager report will now appear as "983 22 1234". **NOTE:** See CS Receiver Options to select Pager Format.

1. Enter in 1st and 2nd Leading Digits as shown (right nibble).
2. Valid entries are: 0-9. Press to save.

SYSTEM OPTIONS (ADDRESS 0836-0871 & 2045)

SYSTEM RESPONSE ACTIVATED BY GLOBAL EVENT/TROUBLE	ADDR	GLOBAL SYSTEM EVENT/TROUBLE							
		TEST TIMER	TELCO FAILURE	RF RCVR. TROUBLE	MEMORY FAILURE	LOW BATTERY	AC FAIL	EZM TAMPER	Bell Superv
		1	2	3	4	5	6	7	8
Alarm Output	0836								
Pulsed Alarm Output	0837								
PGM1 Output	0838								
PGM2 Output	0839								
Report Event Telco 1	0840								
Report Restore Telco 1	0841								
Report Event Telco 3	0842								
Report Restore Telco 3	0843								

[Default = blank (*) from address 0836-0843]. **Note:** If Test Timer is enabled (above), Digital Dialer Test is also enabled.

SYSTEM RESPONSE ACTIVATED BY AREA 1 EVENT/TROUBLE	ADDR	AREA 1 SYSTEM EVENT/TROUBLE							
		AMBUSH	KEYPAD PANIC	KEYPAD FIRE	KEYPAD AUX.‡	KEYPAD TAMPER	FAIL TO OPEN	FAIL TO CLOSE	Keyfob Low Batt
		1	2	3	4	5	6	7	8
Pulsed Alarm Output	0856								
Alarm Output	0857								
PGM1 Output	0858								
PGM2 Output	0860								
Report Event Telco 1	0861								
Report Event Telco 3	0863								

[Default = blank (*) from address 0856-0863] ‡ **NOTE:** Keypad Aux. is not to be selected for UL Installations.

SYSTEM RESPONSE ACTIVATED BY AREA 2 EVENT/TROUBLE	ADDR	AREA 2 SYSTEM EVENT/TROUBLE							
		AMBUSH	KEYPAD PANIC	KEYPAD FIRE	KEYPAD AUX.‡	KEYPAD TAMPER	FAIL TO OPEN	FAIL TO CLOSE	Keyfob Low Batt
		1	2	3	4	5	6	7	8
Pulsed Alarm Output	0864								
Alarm Output	0865								
PGM1 Output	0866								
PGM2 Output	0868								
Report Event Telco 1	0869								
Report Event Telco 3	0871								

[Default = blank (*) blank (*) from address 0864-0871] ‡ **NOTE:** Keypad Aux. is not to be selected for UL Installations.

1. Select the desired option entering the option number (1-8) for each digit.
2. Enter corresponding option number in address location.

NOTE: Dark shaded data value box shows option not available. Press  to save.

Global Ambush Code	ADDRESS 2045	
	1st digit	2nd digit

[Default = blank (*) blank (*)]

GLOBAL AMBUSH CODE: It is the 2-digits entered immediately prior to the regular disarm code. If "Enable Global Ambush Code" (Address 1422) is selected and Address 2045 is left blank (*), then the 2-digit Global Ambush Code is "99". If "Enable Global Ambush Code" is selected and Address 2045 is **not** left blank (*), then the 2-digit Global Ambush Code is the two digits entered in address 2045.

Enter in address location (both 1st and 2nd digits); valid entries are 1-9.

Press  to save.



SYSTEM OPTIONS (ADDRESS 0872-0887)

SYSTEM RESPONSE ACTIVATED BY AREA 3 EVENT/TROUBLE	ADDR	AREA 3 SYSTEM EVENT/TROUBLE							
		AMBUSH	KEYPAD PANIC	KEYPAD FIRE	KEYPAD AUX. ‡	KEYPAD TAMPER	FAIL TO OPEN	FAIL TO CLOSE	Keyfob Low Batt
		1	2	3	4	5	6	7	8
Pulsed Alarm Output	0872								
Alarm Output	0873								
PGM1 Output	0874								
PGM2 Output	0876								
Report Event Telco 1	0877								
Report Event Telco 3	0879								



[Default = blank (*) from address 0872-0879] ‡ **NOTE:** Keypad Aux. is not to be selected for UL Installations.

SYSTEM RESPONSE ACTIVATED BY AREA 4 EVENT/TROUBLE	ADDR	AREA 4 SYSTEM EVENT/TROUBLE							
		AMBUSH	KEYPAD PANIC	KEYPAD FIRE	KEYPAD AUX. ‡	KEYPAD TAMPER	FAIL TO OPEN	FAIL TO CLOSE	Keyfob Low Batt
		1	2	3	4	5	6	7	8
Pulsed Alarm Output	0880								
Alarm Output	0881								
PGM1 Output	0882								
PGM2 Output	0884								
Report Event Telco 1	0885								
Report Event Telco 3	0887								

[Default = blank (*) blank (*) from address 0880-0887] ‡ **NOTE:** Keypad Aux. is not to be selected for UL Installations.

 1. Select the desired option entering the option number (1-8) for each digit.

 2. Enter corresponding option number in address location.

 **NOTE:** Dark shaded data value box shows option not available. Press  to save.

SYSTEM OPTIONS (ADDRESS 1420-1424, 2051-2054)

1420 System Options		
Default		Option
OFF	1	Opening Report Only after Alarm Report
OFF	2	Closing Report Only on Conditional Close
OFF	3	Incl. Sel./Grp. Bypass in Cond. Close /Status
OFF	4	Status Report
OFF	5	RESERVED
OFF	6	Enable AutoArm if not closed at end of Window
OFF	7	Enable Keypad Time/Date Display
OFF	8	Disable Zone Fault Scrolling

1422 System Options		
Default		Option
OFF	1	Interior Normally Bypassed
OFF	2	Enable Global Ambush Code ***
OFF	3	Reset Day Zone with Arm/Disarm Only
OFF	4	Enable Residential Fire
OFF	5	Disable Keypad Function Mode Download
OFF	6	Disable Callback Download
OFF	7	Chirp Output on Keyfob Arm/Disarm
OFF	8	Change Pulse Output to Temporal Output [§]

1424 System Options		
Default		Option
OFF	1	Automatic Interior Bypass/Easy Exit
OFF	2	Veri-phone Zones Trip PGM2 Output
OFF	3	Veri-phone Audio Priority Over Alarms
OFF	4	Resound on Wireless Smoke Low Battery
OFF	5	Don't Clear PGM2 Output with Disarm
OFF	6	Disable 2nd Call Ans. Machine Override
OFF	7	RESERVED
ON	8	Disable Code Required for EZ Bypass

2052 E15 Lug / System Options		
Default		Option
OFF	1	RESERVED
OFF	2	RESERVED
OFF	3	Lug E15 Area 1 Armed Away Only**** [‡]
OFF	4	PGM on RF Transmitter Tamper [‡]
OFF	5	RESERVED
OFF	6	RESERVED
OFF	7	RESERVED
OFF	8	RESERVED

1421 System Options		
Default		Option
OFF	1	Auto Bell Test on Arming
OFF	2	Auto Reset after Burglary Output Timeout
OFF	3	Suppress Bypass Reminder when Armed
OFF	4	Enable Local Alarm on First Zone AND Trip
OFF	5	Access Control on PGM2 Output
OFF	6	Maintained Keyswitch Arming
OFF	7	RESERVED
OFF	8	Disable Keypad Instant Mode

1423 System Options		
Default*		Option
OFF*	1	Enable Zone Doubling (Zones 9-16)
OFF*	2	Wireless Trouble Activates Telco 1
OFF*	3	Wireless Trouble Activates Telco 3
OFF*	4	Enable Alarm Output on Telco Fail only when Armed
OFF*	5	Line-Fault Test only when Armed**
OFF*	6	Enable Line-Fault Test**
OFF*	7	Inhibit System Trouble Audible at Keypad [‡]
OFF*	8	Select Alarm Output for Keyfob Chirp

2051 System Options		
Default		Option
OFF	1	Enable Keypad Set Time/Date Message
OFF	2	Enable Cancel Report to Telco 3
OFF	3	Disable [ON/OFF] as Easy Exit
OFF	4	Enable GEM-PRINT Module
OFF	5	RESERVED
OFF	6	RESERVED
OFF	7	Disable System Trouble Audible Timeout
OFF	8	Enable "K Series" Style Keypads ^{††}

2053 System Options		
Default		Option
OFF	1	Exit Time Restart
OFF	2	Sound Alarm On Exit Error
OFF	3	Rpt Exit Err/Recent Close
OFF	4	Enable CP-01 Limits
OFF	5	Digital Dialer Rpt Enter /Exit Test Mode
OFF	6	Disable Call Waiting on 1st Attempt
OFF	7	Enable Keypad 1 Only Programming
OFF	8	Enable CP-01 Egress Tones Only

2054 System Options		
Default		Option
OFF	1	Enable TCP/IP Communications [‡]
OFF	2	RESERVED
OFF	3	TCP/IP Panel/Site Initiated Functions
OFF	4	RESERVED
OFF	5	RESERVED
OFF	6	RESERVED
OFF	7	RESERVED
OFF	8	RESERVED

Address 1423: Default depends on Easy Menu Question : "EZ ZONE DOUBLING? y/n". If yes, then [Default = 1]. If no, then [Default = blank ()].

**To select "Line-Fault Test only when Armed", you must also select "Enable Line-Fault Test" at address 1423.

***If "Enable Global Ambush Code" in Address 1422 is selected, then program the 2-digit "Global Ambush Code" in Address 2045. If Address 2045 is left blank (*), then, the 2-digit "Global Ambush Code" will be "99".

****If this feature is not selected, the E15 Lug will, by default, activate when the system is armed (all areas).

[‡]Not for UL Installations

[§]This feature must be programmed in Fire Alarm applications.

^{††}For reference only and cannot be changed.



CS RECEIVER OPTIONS (ADDRESS 0460-0525)

CS Receiver 1 Format	ADDRESS 0460	CS Receiver 2 Format	ADDRESS 0482	CS Receiver 3 Format	ADDRESS 0504
--------------------------------	---------------------	--------------------------------	---------------------	--------------------------------	---------------------

DATA ENTRY	CS RECEIVER 1 FORMAT
blank (*)	Ademco Slow, Silent Knight Slow
2	Radionics Fast
3	Silent Knight Fast
4	Radionics, DCI, Franklin Slow
5	Universal High Speed
B	SIA
C	Ademco Point ID
E	Pager *

Default for CS Receiver 1 Format depends on Easy Menu Question "RCVR FORMAT". [Default = *(blank) * (blank)] for CS Receivers 2 and 3 Formats.

CS RECEIVER FORMATS: Up to 3 CS Formats may be programmed.

1. Select the desired CS Receiver Format from the table shown.
2. Enter the corresponding digit in the address location for each CS Receiver. **NOTE:** Dark shaded data value box shows option not available. Press [Enter] to save.

NOTE: * See Pager Format Options to program Leading Digits for Pager Format.

0461	CS Receiver Options - Telco 1	
Default	Option	Option
OFF	1	1400Hz Handshake/Kissoff *
OFF	2	2300Hz Handshake/Kissoff *
OFF	3	Enable Zone Number on Pulse Alarm
OFF	4	Single Digit Only
OFF	5	Sum Check
OFF	6	3/1 with Extended Restores
OFF	7	Enable TCP/IP AES RPT
OFF	8	RESERVED

0483	CS Receiver Options - Telco 2	
Default	Option	Option
OFF	1	1400Hz Handshake/Kissoff *
OFF	2	2300Hz Handshake/Kissoff *
OFF	3	Enable Zone Number on Pulse Alarm
OFF	4	Single Digit Only
OFF	5	Sum Check
OFF	6	3/1 with Extended Restores
OFF	7	Enable TCP/IP AES RPT
OFF	8	RESERVED

0505	CS Receiver Options - Telco 3	
Default	Option	Option
OFF	1	1400Hz Handshake/Kissoff *
OFF	2	2300Hz Handshake/Kissoff *
OFF	3	Enable Zone Number on Pulse Alarm
OFF	4	Single Digit Only
OFF	5	Sum Check
OFF	6	3/1 with Extended Restores
OFF	7	Enable TCP/IP AES RPT
OFF	8	RESERVED

CS RECEIVER OPTIONS:

Select options for any of the three CS Receivers.

1. Select the desired option entering the option number (1-8) for each digit.
2. Enter corresponding option number in address location (right nibble).

NOTE: Dark shaded data value box shows option not available. Press [Enter] to save.

***NOTE:** If both are selected, 1400Hz has priority over 2300Hz.

CS Receiver 1	ADDRESS 0462-0481 (RIGHT DIGITS 1-20)																			
Telephone Number	0462	0463	0464	0465	0466	0467	0468	0469	0470	0471	0472	0473	0474	0475	0476	0477	0478	0479	0480	0481
(Digits 1-20)																				

CS Receiver 2	ADDRESS 0484-0503 (RIGHT DIGITS 1-20)																			
Telephone Number	0484	0485	0486	0487	0488	0489	0490	0491	0492	0493	0494	0495	0496	0497	0498	0499	0500	0501	0502	0503
(Digits 1-20)																				

CS Receiver 3	ADDRESS 0506-0525 (RIGHT DIGITS 1-20)																			
Telephone Number	0506	0507	0508	0509	0510	0511	0512	0513	0514	0515	0516	0517	0518	0519	0520	0521	0522	0523	0524	0525
(Digits 1-20)																				

Default for CS Receiver 1 Telephone Number depends on Easy Menu Question "CENTRAL PHONE #".

[Default = blank (*)] across digits 1-20 for CS Receiver Telephone Numbers 2 and 3.

CS RECEIVER TELEPHONE NUMBERS: Enter telephone numbers for any of the three CS Receivers (Telco 1, 2 & 3).

1. Enter digit only.
2. Enter up to 20 digits from left to right. **NOTE:** Leave trailing boxes blank (*). Press [Enter] to save.
3. Valid entries are: 1-9, B = [*] button, C = [#] button, D = 3 sec. pause, E = Wait for dial tone, F = Ignore location

CS SUBSCRIBER ID OPTIONS (ADDRESS 0560-0667)

CS Telco 1 Sub- scriber Opening/ Closing ID Number (Area 1)	ADDRESS 0560-0563 (RIGHT DIGITS 1-4)			
	0560	0561	0562	0563

CS Telco 1 Sub- scriber Opening/ Closing ID Number (Area 2)	ADDRESS 0564-0567 (RIGHT DIGITS 1-4)			
	0564	0565	0566	0567

CS Telco 1 Sub- scriber Opening/ Closing ID Number (Area 3)	ADDRESS 0568-0571 (RIGHT DIGITS 1-4)			
	0568	0569	0570	0571

CS Telco 1 Sub- scriber Opening/ Closing ID Number (Area 4)	ADDRESS 0572-0575 (RIGHT DIGITS 1-4)			
	0572	0573	0574	0575

CS Telco 1 Sub- scriber Event ID Number (Area 1)	ADDRESS 0576-0579 (RIGHT DIGITS 1-4)			
	0576	0577	0578	0579

CS Telco 1 Sub- scriber Event ID Number (Area 2)	ADDRESS 0580-0583 (RIGHT DIGITS 1-4)			
	0580	0581	0582	0583

CS Telco 1 Sub- scriber Event ID Number (Area 3)	ADDRESS 0584-0587 (RIGHT DIGITS 1-4)			
	0584	0585	0586	0587

CS Telco 1 Sub- subscriber Event ID Number (Area 4)	ADDRESS 0588-0591 (RIGHT DIGITS 1-4)			
	0588	0589	0590	0591

CS Telco 1 Sub- subscriber Event ID Number (System)	ADDRESS 0592-0595 (RIGHT DIGITS 1-4)			
	0592	0593	0594	0595

CS Telco 2 Sub- scriber Opening/ Closing ID Number (Area 1)	ADDRESS 0596-0599 (RIGHT DIGITS 1-4)			
	0596	0597	0598	0599

CS Telco 2 Sub- subscriber Opening/ Closing ID Number (Area 2)	ADDRESS 0600-0603 (RIGHT DIGITS 1-4)			
	0600	0601	0602	0603

CS Telco 2 Sub- scriber Opening/ Closing ID Number (Area 3)	ADDRESS 0604-0607 (RIGHT DIGITS 1-4)			
	0604	0605	0606	0607

CS Telco 2 Sub- subscriber Opening/ Closing ID Number (Area 4)	ADDRESS 0608-0611 (RIGHT DIGITS 1-4)			
	0608	0609	0610	0611

CS Telco 2 Sub- subscriber Event ID Number (Area 1)	ADDRESS 0612-0615 (RIGHT DIGITS 1-4)			
	0612	0613	0614	0615

CS Telco 2 Sub- subscriber Event ID Number (Area 2)	ADDRESS 0616-0619 (RIGHT DIGITS 1-4)			
	0616	0617	0618	0619

CS Telco 2 Sub- subscriber Event ID Number (Area 3)	ADDRESS 0620-0623 (RIGHT DIGITS 1-4)			
	0620	0621	0622	0623

CS Telco 2 Sub- subscriber Event ID Number (Area 4)	ADDRESS 0624-0627 (RIGHT DIGITS 1-4)			
	0624	0625	0626	0627

CS Telco 2 Sub- subscriber Event ID Number (System)	ADDRESS 0628-0631 (RIGHT DIGITS 1-4)			
	0628	0629	0630	0631

CS Telco 3 Sub- scriber Opening/ Closing ID Number (Area 1)	ADDRESS 0632-0635 (RIGHT DIGITS 1-4)			
	0632	0633	0634	0635

CS Telco 3 Sub- subscriber Opening/ Closing ID Number (Area 2)	ADDRESS 0636-0639 (RIGHT DIGITS 1-4)			
	0636	0637	0638	0639

CS Telco 3 Sub- subscriber Opening/ Closing ID Number (Area 3)	ADDRESS 0640-0643 (RIGHT DIGITS 1-4)			
	0640	0641	0642	0643

CS Telco 3 Sub- subscriber Opening/ Closing ID Number (Area 4)	ADDRESS 0644-0647 (RIGHT DIGITS 1-4)			
	0644	0645	0646	0647

CS Telco 3 Sub- subscriber Event ID Number (Area 1)	ADDRESS 0648-0651 (RIGHT DIGITS 1-4)			
	0648	0649	0650	0651

CS Telco 3 Sub- subscriber Event ID Number (Area 2)	ADDRESS 0652-0655 (RIGHT DIGITS 1-4)			
	0652	0653	0654	0655

CS Telco 3 Sub- subscriber Event ID Number (Area 3)	ADDRESS 0656-0659 (RIGHT DIGITS 1-4)			
	0656	0657	0658	0659

CS Telco 3 Sub- subscriber Event ID Number (Area 4)	ADDRESS 0660-0663 (RIGHT DIGITS 1-4)			
	0660	0661	0662	0663

CS Telco 3 Sub- subscriber Event ID Number (System)	ADDRESS 0664-0667 (RIGHT DIGITS 1-4)			
	0664	0665	0666	0667

Default for CS Telco 1 Subscriber Event ID Number (Area 1) depends on Easy Menu Question "ACCOUNT #". [Default = blank (*) blank (*) blank (*) blank (*)] for all other ID Numbers.

CS TELCO SUBSCRIBER ID NUMBERS: Enter the Subscriber Opening/Closing and Event ID Numbers for any of the 3 CS Receivers.

1. Enter 3 or 4 digits (depending on the CS receiver format) for each subscriber number from left to right.

NOTE: Leave trailing boxes blank (*).



CS SYSTEM REPORTING OPTIONS (ADDRESS 0670-0705)

CS SYSTEM REPORTING CODES	ADDRESS 0670-0682	
	ADDR	
Alarm Restore	blank (*)	0670
Trouble	blank (*)	0671
Trouble Restore	blank (*)	0672
Xmitter Low Battery	blank (*)	0673
Xmitter Supervision	blank (*)	0674
Xmitter Tamper	blank (*)	0675
RESERVED	blank (*)	blank (*)
Opening	blank (*)	0677
Closing	blank (*)	0678
Opening after Alarm	blank (*)	0679
Conditional Close	blank (*)	0680
Cancel	blank (*)	0681
Test Timer		0682

CS SYSTEM REPORTING CODES	ADDRESS 0683-0708	
	ADDR	
Telco Fail		0683
RF Rec. Trouble		0684
Memory Fail		0685
Low Battery		0686
Panel AC Fail		0687
EZM Tamper		0688
Alarm Output Superv.		0689
Ambush		0698
Panic		0699
Fire		0700
Auxiliary ‡		0701
Tamper		0702
Fail to Open		0703
Fail to Close		0704
Keyfob Low Battery		0705

CS SYSTEM REPORTING CODES:

1. Enter in corresponding address location (left and right digits).
NOTE: Left digit is the first digit and right digit is the second digit in a two digit CS receiver format.
 2. Valid entries are: 1-9, 0 and B-F.
NOTE: A is not permitted.
 3. To disable a code leave boxes blank (*).
NOTE: Dark shaded data value box shows option not available.
 4. Press to save.
- ‡ **NOTE:** Keypad Aux. is not to be selected for UL Installations.

[Default = blank (*) blank (*) from address 0670-0682]
[Default = blank (*) blank (*) from address 0683-0705]

CS AREA & SYSTEM REPORTING OPTIONS (ADDRESS 0785, 0786 & 0788)

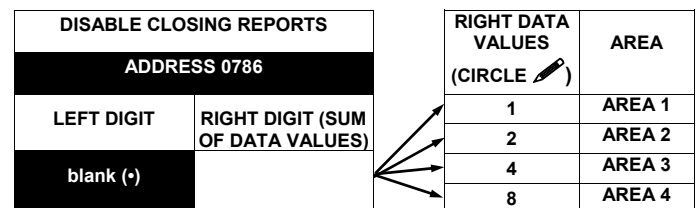
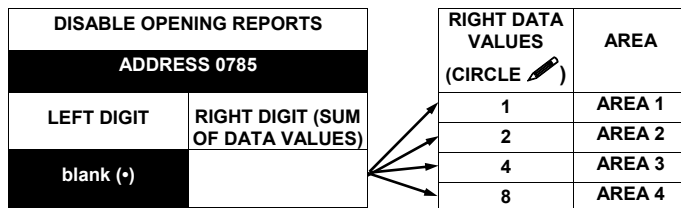

[Default = blank (*) blank (*)]

[Default = blank (*) blank (*)]

OPENING REPORT OPTIONS:

1. Select the desired option by circling the data values for each digit (left and right).
2. Add the data values (ex: F=15=(1+2+4+8) from the selected options. See page 13).
3. Enter in address location (left and right digits).

NOTE: Dark shaded data value box shows option not available. Press to save.

0788	CS System Report Options	
Default		Option
OFF	1	Backup Report on Telco 1 & 2
ON	2	Touch-tone Dialing Only *
OFF	3	Touch-tone Dialing w/Rotary Backup *
OFF	4	RESERVED
OFF	5	Cancel Next Test Timer on any Report
OFF	6	Disable Wait for Silence (Pager Format)
OFF	7	Disable Wait for Handshake on Transmit
OFF	8	Disable Auto Dial Tone Detect

CS SYSTEM REPORTING OPTIONS:

1. Select the desired option entering the option number (1-8) for each digit.
 2. Enter corresponding option number in address location.
- NOTE:** Dark shaded data value box shows option not available.
3. Press to save.

* **NOTE:** If neither Touch-tone Dialing nor Touch-tone w/ Rotary Backup is selected, then system defaults automatically to Rotary Dialing. Leave blank (*) to select Rotary Dialing.

CS ZONE REPORTING OPTIONS (ADDRESS 0720-0783)

ADDRESS 0720-0727							
CONTROL PANEL ZONES REPORT CODE							
ZONE 1	ZONE 2	ZONE 3	ZONE 4	ZONE 5	ZONE 6	ZONE 7	ZONE 8
0720	0721	0722	0723	0724	0725	0726	0727

ADDRESS 0728-0731			
ZONES REPORT CODE			
ZONE 9	ZONE 10	ZONE 11	ZONE 12
0728	0729	0730	0731

ADDRESS 0732-0735			
ZONES REPORT CODE			
ZONE 13	ZONE 14	ZONE 15	ZONE 16
0732	0733	0734	0735

ADDRESS 0736-0739			
ZONES REPORT CODE			
ZONE 17	ZONE 18	ZONE 19	ZONE 20
0736	0737	0738	0739

ADDRESS 0740-0743			
ZONES REPORT CODE			
ZONE 21	ZONE 22	ZONE 23	ZONE 24
0740	0741	0742	0743

ADDRESS 0744-0747			
ZONES REPORT CODE			
ZONE 25	ZONE 26	ZONE 27	ZONE 28
0744	0745	0746	0747

ADDRESS 0748-0751			
ZONES REPORT CODE			
ZONE 29	ZONE 30	ZONE 31	ZONE 32
0748	0749	0750	0751

ADDRESS 0752-0759							
CONTROL PANEL ZONES REPORT CODE							
ZONE 33	ZONE 34	ZONE 35	ZONE 36	ZONE 37	ZONE 38	ZONE 39	ZONE 40
0752	0753	0754	0755	0756	0757	0758	0759

ADDRESS 0760-0763			
ZONES REPORT CODE			
ZONE 41	ZONE 42	ZONE 43	ZONE 44
0760	0761	0762	0763

ADDRESS 0764-0767			
ZONES REPORT CODE			
ZONE 45	ZONE 46	ZONE 47	ZONE 48
0764	0765	0766	0767

ADDRESS 0768-0771			
ZONES REPORT CODE			
ZONE 49	ZONE 50	ZONE 51	ZONE 52
0768	0769	0770	0771

ADDRESS 0772-0775			
ZONES REPORT CODE			
ZONE 53	ZONE 54	ZONE 55	ZONE 56
0772	0773	0774	0775

ADDRESS 0776-0779			
ZONES REPORT CODE			
ZONE 57	ZONE 58	ZONE 59	ZONE 60
0776	0777	0778	0779

ADDRESS 0780-0783			
ZONES REPORT CODE			
ZONE 61	ZONE 62	ZONE 63	ZONE 64
0780	0781	0782	0783

Default for Group Zone Report Codes depends on Easy Menu Question "RCVR. FORMAT".

ZONE REPORT CODE OPTIONS	
DATA ENTRIES	

NOTE: If "Zone Doubling" (Address 1423) is **not** enabled, then Zones 1-8 are included in the control panel and Zones 9-64 are EZM Zones. If "Zone Doubling" is enabled, then Zones 1-16 are included in the control panel and Zones 17-64 are EZM Zones. See Address 1455-1468 to enable "EZM Group Options".

DATA ENTRIES LEFT	MODEM CODE
1	Fire
2	Panic
3	Burglary
4	Hold up
7	Gas Alarm
8	Heat Alarm
0	Auxiliary Alarm
B	24 Hour Auxiliary

PULSE EVENT CODE will be the first digit of the 2 digit reporting code. The second digit will be the second digit of the reporting zone. For example, for zone 9 (address 0728), if the right digit is "3", then the reporting code is "39". For example, for zone 15 (address 0734), if the right digit is "4", then the reporting code is "45".

MODEM CODES determine the zone types reported for the following formats: SIA and ADEMCO Point ID.

1. Select the desired Modem Code for each zone from the table shown.



CS USER REPORTING OPTIONS (ADDRESS 0800-0835)

Enable Users to Report Opening and Closings	ADDR	USERS 1 → 8								ADDR	USERS 9 → 16							
		U1	U2	U3	U4	U5	U6	U7	U8		U9	U10	U11	U12	U13	U14	U15	U16
		1	2	3	4	5	6	7	8		1	2	3	4	5	6	7	8
Enable Opening Report, Telco 1	0800									0801								
Enable Closing Report, Telco 1	0809									0810								
Enable Opening Report, Telco 3	0818									0819								
Enable Closing Report, Telco 3	0827									0828								

Enable Users to Report Opening and Closings	ADDR	USERS 17 → 24								ADDR	USERS 25 → 32							
		U17	U18	U19	U20	U21	U22	U23	U24		U25	U26	U27	U28	U29	U30	U31	U32
		1	2	3	4	5	6	7	8		1	2	3	4	5	6	7	8
Enable Opening Report, Telco 1	0802									0803								
Enable Closing Report, Telco 1	0811									0812								
Enable Opening Report, Telco 3	0820									0821								
Enable Closing Report, Telco 3	0829									0830								

Enable Users to Report Opening and Closings	ADDR	USERS 33 → 40								ADDR	USERS 41 → 48							
		U33	U34	U35	U36	U37	U38	U39	U40		U41	U42	U43	U44	U45	U46	U47	U48
		1	2	3	4	5	6	7	8		1	2	3	4	5	6	7	8
Enable Opening Report, Telco 1	0804									0805								
Enable Closing Report, Telco 1	0813									0814								
Enable Opening Report, Telco 3	0822									0823								
Enable Closing Report, Telco 3	0831									0832								

Enable Users to Report Opening and Closings	ADDR	USERS 49 → 56								ADDR	USERS 57 → 64							
		U49	U50	U51	U52	U53	U54	U55	U56		U57	U58	U59	U60	U61	U62	U63	U64
		1	2	3	4	5	6	7	8		1	2	3	4	5	6	7	8
Enable Opening Report, Telco 1	0806									0807								
Enable Closing Report, Telco 1	0815									0816								
Enable Opening Report, Telco 3	0824									0825								
Enable Closing Report, Telco 3	0833									0834								

Enable Users to Report Opening and Closings	ADDR	USERS 65 → 68								ADDR	USERS 69 → 76							
		U65	U66	U67	U68						U69	U70	U71	U72	U73	U74	U75	U76
		1	2	3	4	5	6	7	8		1	2	3	4	5	6	7	8
Enable Opening Report, Telco 1	0808																	
Enable Closing Report, Telco 1	0817																	
Enable Opening Report, Telco 3	0826																	
Enable Closing Report, Telco 3	0835																	

User 65 = Auto Arming/Disarming
 User 66 = Quickloader Remote Arming/Disarming
 User 67 = Easy Arming (Opening not applicable)
 User 68 = Keyswitch Arming
NOTE: These opening events will report as the user number shown. Also, Keyfobs 1-8 (see Easy Menu Program Driven Mode) will report as Users 57-64, respectively.

CS USER REPORTING OPTIONS: [Default = blank (•) from address 0800-0835]

1. Select the desired option entering the option number (1-8) for each digit.
2. At the keypad, enter corresponding option number in address location. **NOTE:** Dark shaded data value box shows option not available.
3. Press to save.

EZM GROUP OPTIONS (ADDRESS 1455-1468)

EZM Group 1 ADDRESS 1455	EZM Group 2 ADDRESS 1456	EZM Group 3 ADDRESS 1457	EZM Group 4 ADDRESS 1458	EZM Group 5 ADDRESS 1459	EZM Group 6 ADDRESS 1460
EZM Group 7 ADDRESS 1461	EZM Group 8 ADDRESS 1462	EZM Group 9 ADDRESS 1463	EZM Group 10 ADDRESS 1464	EZM Group 11 ADDRESS 1465	EZM Group 12 ADDRESS 1466
EZM Group 13 ADDRESS 1467	EZM Group 14 ADDRESS 1468				

Default depends on Easy Menu Question “# OF ZNS IN AREA 1 ENTER # ZONES” and “EZ ZONE DOUBLING? Y/N”. For example, if 64 Zones are used and Zone Doubling is **not** enabled, then all 14 Groups will be automatically enabled. If 64 Zones are used and Zone Doubling is enabled, then only Groups 1-12 will be automatically enabled.

NOTE: If “Zone Doubling” (Address 1423, option 1) is **not** enabled, then Zones 1-8 are included in the control panel and Zones 9-64 (Groups 1-14) are EZM Zones. If “Zone Doubling” is enabled, then Zones 1-16 are included in the control panel and Zones 17-64 (Groups 1-12) are EZM Zones (and Groups 13 and 14 must not be used).

EZM TYPE		EZM GROUP	ZONES COVERED	
DATA ENTRIES	OPTION		NORMAL	DOUBLED
blank (*)	Not used (No EZM present)	1	9-12	17-20
		2	13-16	21-24
		3	17-20	25-28
		4	21-24	29-32
		5	25-28	33-36
		6	29-32	37-40
		7	33-36	41-44
		8	37-40	45-48
		9	41-44	49-52
		10	45-48	53-56
		11	49-52	57-60
		12	53-56	61-64
1	4-Zone EZM	13	57-60	
		14	61-64	

EZM GROUP OPTIONS: Up to 14 Groups of 4 Zones each may be programmed depending on the number of Zones used and which EZM modules are connected. Each Group represents 4 Zones.

1. Select EZM type from the table shown.
2. Enter either blank (*) or "1" in corresponding address locations above.

NOTE: Dark shaded data value box shows option not available.

3. Press to save.

AREA ARMING OPTIONS (ADDRESS 1469-1472)

"Arming Area 1" Options	ADDRESS 1469	"Arming Area 2" Options	ADDRESS 1470	"Arming Area 3" Options	ADDRESS 1471	"Arming Area 4" Options	ADDRESS 1472
--------------------------------	------------------------	--------------------------------	------------------------	--------------------------------	------------------------	--------------------------------	------------------------

[Default = blank (●) blank (●)]

[Default = blank (●) blank (●)]

[Default = blank (●) blank (●)]

[Default = blank (●) blank (●)]

PRIORITY ARMING "Arming Area 1" Options	
DATA ENTRIES	OPTION
blank (*) blank (*)	Not Used
● E	Priority Areas 2, 3 and 4
● 2	Priority Area 2
● 4	Priority Area 3
● 8	Priority Area 4

PRIORITY ARMING "Arming Area 2" Options	
DATA ENTRIES	OPTION
blank (*) blank (*)	Not Used
● D	Priority Areas 1, 3 and 4
● 1	Priority Area 1
● 4	Priority Area 3
● 8	Priority Area 4

PRIORITY ARMING "Arming Area 3" Options	
DATA ENTRIES	OPTION
blank (*) blank (*)	Not Used
● B	Priority Areas 1, 2 and 4
● 1	Priority Area 1
● 2	Priority Area 2
● 8	Priority Area 4

PRIORITY ARMING "Arming Area 4" Options	
DATA ENTRIES	OPTION
blank (*) blank (*)	Not Used
● 7	Priority Areas 1, 2 and 3
● 1	Priority Area 1
● 2	Priority Area 2
● 4	Priority Area 3

PRIORITY AREA ARMING:

Prevents area arming if the associated "Priority Area" has not yet been armed. In other words, the "Priority Area" must be armed before the "Arming Area" can be armed.

1. Select option from the table shown.

2. Enter either "blank (*) blank (*)" or other digits/letters in corresponding address location. **NOTE:** Dark shaded data value box shows option not available.

3. Press to save.



AREA BELL CONTROL OPTIONS (ADDRESS 1473-1488)

1473 Burglary Output Turns Off upon Disarm		
Default		Option: Disarming Area 1:
ON	1	Area 1 Burg Output Silenced
OFF	2	Area 2 Burg Output Silenced
OFF	3	Area 3 Burg Output Silenced
OFF	4	Area 4 Burg Output Silenced

1474 Burglary Output Turns Off upon Disarm		
Default		Option: Disarming Area 2:
ON	1	Area 1 Burg Output Silenced
OFF	2	Area 2 Burg Output Silenced
OFF	3	Area 3 Burg Output Silenced
OFF	4	Area 4 Burg Output Silenced

1475 Burglary Output Turns Off upon Disarm		
Default		Option: Disarming Area 3:
ON	1	Area 1 Burg Output Silenced
OFF	2	Area 2 Burg Output Silenced
OFF	3	Area 3 Burg Output Silenced
OFF	4	Area 4 Burg Output Silenced

1476 Burglary Output Turns Off upon Disarm		
Default		Option: Disarming Area 4:
ON	1	Area 1 Burg Output Silenced
OFF	2	Area 2 Burg Output Silenced
OFF	3	Area 3 Burg Output Silenced
OFF	4	Area 4 Burg Output Silenced

1477 Pulsed Burg Output Turns Off upon Disarm		
Default		Option: Disarming Area 1:
ON	1	Area 1 Pulsed Burg Output Silenced
OFF	2	Area 2 Pulsed Burg Output Silenced
OFF	3	Area 3 Pulsed Burg Output Silenced
OFF	4	Area 4 Pulsed Burg Output Silenced

1478 Pulsed Burg Output Turns Off upon Disarm		
Default		Option: Disarming Area 2:
ON	1	Area 1 Pulsed Burg Output Silenced
OFF	2	Area 2 Pulsed Burg Output Silenced
OFF	3	Area 3 Pulsed Burg Output Silenced
OFF	4	Area 4 Pulsed Burg Output Silenced

1479 Pulsed Burg Output Turns Off upon Disarm		
Default		Option: Disarming Area 3:
ON	1	Area 1 Pulsed Burg Output Silenced
OFF	2	Area 2 Pulsed Burg Output Silenced
OFF	3	Area 3 Pulsed Burg Output Silenced
OFF	4	Area 4 Pulsed Burg Output Silenced

1480 Pulsed Burg Output Turns Off upon Disarm		
Default		Option: Disarming Area 4:
ON	1	Area 1 Pulsed Burg Output Silenced
OFF	2	Area 2 Pulsed Burg Output Silenced
OFF	3	Area 3 Pulsed Burg Output Silenced
OFF	4	Area 4 Pulsed Burg Output Silenced

1481 PGM1 Output Turns Off upon Disarm		
Default		Option: Disarming Area 1:
ON	1	Area 1 PGM1 Output Silenced
OFF	2	Area 2 PGM1 Output Silenced
OFF	3	Area 3 PGM1 Output Silenced
OFF	4	Area 4 PGM1 Output Silenced

1482 PGM1 Output Turns Off upon Disarm		
Default		Option: Disarming Area 2:
ON	1	Area 1 PGM1 Output Silenced
OFF	2	Area 2 PGM1 Output Silenced
OFF	3	Area 3 PGM1 Output Silenced
OFF	4	Area 4 PGM1 Output Silenced

1483 PGM1 Output Turns Off upon Disarm		
Default		Option: Disarming Area 3:
ON	1	Area 1 PGM1 Output Silenced
OFF	2	Area 2 PGM1 Output Silenced
OFF	3	Area 3 PGM1 Output Silenced
OFF	4	Area 4 PGM1 Output Silenced

1484 PGM1 Output Turns Off upon Disarm		
Default		Option: Disarming Area 4:
ON	1	Area 1 PGM1 Output Silenced
OFF	2	Area 2 PGM1 Output Silenced
OFF	3	Area 3 PGM1 Output Silenced
OFF	4	Area 4 PGM1 Output Silenced

1485 PGM2 Output Turns Off upon Disarm		
Default		Option: Disarming Area 1:
ON	1	Area 1 PGM2 Burg Output Silenced
OFF	2	Area 2 PGM2 Burg Output Silenced
OFF	3	Area 3 PGM2 Burg Output Silenced
OFF	4	Area 4 PGM2 Burg Output Silenced



1486 PGM2 Output Turns Off upon Disarm		
Default		Option: Disarming Area 2:
ON	1	Area 1 PGM2 Burg Output Silenced
OFF	2	Area 2 PGM2 Burg Output Silenced
OFF	3	Area 3 PGM2 Burg Output Silenced
OFF	4	Area 4 PGM2 Burg Output Silenced

1487 PGM2 Output Turns Off upon Disarm		
Default		Option: Disarming Area 3:
ON	1	Area 1 PGM2 Burg Output Silenced
OFF	2	Area 2 PGM2 Burg Output Silenced
OFF	3	Area 3 PGM2 Burg Output Silenced
OFF	4	Area 4 PGM2 Burg Output Silenced

1488 PGM2 Output Turns Off upon Disarm		
Default		Option: Disarming Area 4:
ON	1	Area 1 PGM2 Burg Output Silenced
OFF	2	Area 2 PGM2 Burg Output Silenced
OFF	3	Area 3 PGM2 Burg Output Silenced
OFF	4	Area 4 PGM2 Burg Output Silenced

OUTPUT TURNS OFF UPON DISARM:

Select options for any of the 4 Outputs. By default, the ability to turn off an output upon disarm is not allowed. For example, the ability to silence an Area 1 through Area 4 output via an Area 1 keypad is not enabled by default. To enable selected area output control, enter the number (1,2,3,4) accordingly. For example, if you wish to grant an Area 1 keypad the ability to turn off an Area 2 PGM2 output, enter "2" in Address 1485.

 Enter digit in address location. **NOTE:** Dark shaded data value box shows option not available. Press  to save.

KEYPAD OPTIONS (ADDRESS 1425-1431, 1440-1446)

Enable Keypad Type & Activation	ADDR	Enable Keypad Type	Keypad Area Assignment
		Blank (*) = Burg Keypad 2 = Wizard ‡ ‡Not for UL Installations	Blank (*) = Disabled 1 = Area 1 2 = Area 2 3 = Area 3 4 = Area 4
Keypad 1	1425		
Keypad 2	1426		
Keypad 3	1427		
Keypad 4	1428		
Keypad 5	1429		
Keypad 6	1430		
Keypad 7	1431		

[Default = blank (*) from address 1425-1431]

KEYPAD TYPE: Up to 7 keypads may be programmed, if they are connected.

NOTE: See Keypad Configuration Mode.

1. Select keypad type for each keypad from the tables shown.
2. Enter data in corresponding address locations.
3. Press  to save.

Enable Keypad Options	ADDR	Enable Keypad Options							
		Keypad Fire	Keypad Aux. ‡	Keypad Panic	RSRVD	Ambush	Easy Arming	Panel Access	RSRVD
		1	2	3	4	5	6	7	8
Keypad 1 Options	1440								
Keypad 2 Options	1441								
Keypad 3 Options	1442								
Keypad 4 Options	1443								
Keypad 5 Options	1444								
Keypad 6 Options	1445								
Keypad 7 Options	1446								

[Default = blank (*) from address 1440-1446] ‡ **NOTE:** Keypad Aux. is not to be selected for UL Installations.

ENABLE KEYPAD OPTIONS: Select options for any of the 7 keypads.

1. Select the desired option entering the option number (1-8) for each digit.
2. At the keypad, enter corresponding option number in address location.

NOTE: Dark shaded data value box shows option not available.

3. Press  to save.

TEMPERATURE DISPLAY AT KEYPAD (ADDRESS 1666-1668)

☞ --ZONE 6 TEMPERATURE SENSOR--

1666 Temperature Lower Limit [‡]		
Default		Option
OFF	1	Binary Temperature Value 1°
OFF	2	Binary Temperature Value 2°
OFF	3	Binary Temperature Value 4°
OFF	4	Binary Temperature Value 8°
OFF	5	Binary Temperature Value 16°
OFF	6	Binary Temperature Value 32°
OFF	7	Binary Temperature Value 64°
OFF	8	Enable for Negative Temperature Value

1667 Temperature Upper Limit [‡]		
Default		Option
OFF	1	Binary Temperature Value 1°
OFF	2	Binary Temperature Value 2°
OFF	3	Binary Temperature Value 4°
OFF	4	Binary Temperature Value 8°
OFF	5	Binary Temperature Value 16°
OFF	6	Binary Temperature Value 32°
OFF	7	Binary Temperature Value 64°
OFF	8	Enable for Negative Temperature Value

1668 Enable Temperature Options [‡]		
Default		Option
OFF	1	Enable Temperature Display Option
OFF	2	Select Degrees Celsius
OFF	3	Report Temperature Alarm (Zone 6)
OFF	4	Reserved
OFF	5	Reserved
OFF	6	Reserved
OFF	7	Reserved
OFF	8	Reserved

Temperature Display at Keypad

The temperature is displayed instead of the date on line 2 of the keypad. The keypad will display from -22F to 140F (or -30C to 60C). Fahrenheit is the default setting, select Celsius by enabling address 1668 option 2. When this Temperature Display Option is enabled, Zone 6 becomes the input for the GEM-TEMP64 Temperature Sensor module and Zone 6 of the panel becomes inoperative; if Zone Doubling is selected, zones 6, 14 will be inoperative.

Address 1668 option 3 enables Zone 6 to report a temperature problem. Address 1666 (options 1-7) set the lower limit temperature value and address 1667 (options 1-7) sets the upper limit temperature value (both values are set in binary). If the temperature detected by the panel is above or below these set limits, the panel will report an alarm on Zone 6. To function and report properly, Zone 6 must be selected as a reporting zone, 24hr zone in area 1 and auto-resettable. At both 1666 and 1667 addresses, option 8 sets positive or negative temperature. If the temperature of 0 degrees is required, "negative zero" (-0) degrees must be used (+0 or an empty location is not a valid temperature). To simulate the sensor module, a power supply can be connected to Zone 6 and set from .55v to 3.05v to display the whole temperature range. Temperature values are read and updated every 5 seconds. To report an outer limit temperature, the temperature must be out of limits for 2 seconds. To avoid false alarm reports, the limits have a threshold of 5 degrees in the software. Two new logs have been created for temperature out of limits and restore. If the  key is depressed and held down for 2 seconds, the date will display for 5 seconds.

In addition, three addresses must be enabled (either via Quickloader or via direct address programming) in order for the **Temperature Display at Keypad** feature to operate.

The following features must be enabled In Quickloader (or in direct address programming):

1. **Keypad Assignment, Temperature Settings** tab, **Enable Temperature Display** (Address 1668, option 1)
2. **Keypad Assignment, Keypad Features** tab, **Enable Keypad Time/Date Display** (Address 1420, option 7)
3. **Keypad Assignment, Keypad Features** tab, **Enable Set Time/Date Message** (Address 2051, option 1)

Note: If these three addresses are set and power (AC and battery) are subsequently removed, they keypad will indicate that the time and date are lost and will need to be reset. See WI1425 for more information. **Note:** The GEM-TEMP64 Temperature Sensor module will only trip once per arming cycle.

[‡]This feature not evaluated by UL.

ZONE OPTIONS - ZONES 1 TO 16 (ADDRESS 0900-1019)

	ZONE OPTIONS	ADDR	ZONES 1 → 8								ADDR	ZONES 9 → 16							
			Z1	Z2	Z3	Z4	Z5	Z6	Z7	Z8		Z9	Z10	Z11	Z12	Z13	Z14	Z15	Z16
			1	2	3	4	5	6	7	8		1	2	3	4	5	6	7	8
	50ms Loop Response (A)	0900								0964									
†	Priority	0901								0965									
	Priority with Bypass	0902								0966									
	Auto-Bypass	0903								0967									
†	Selective Bypass	0904								0968									
	Keyswitch Arming	0905								0969									
	Auto-Bypass Re-entry	0906								0970									
	Pre-Alarm Warning	0907								0971									
	Never Arm	0908								0972									
	24-Hour Zone	0909								0973									
†	Alarm Output	0910								0974									
†	Pulsed Alarm Output	0911								0975									
	PGM1 Output	0912								0976									
	PGM2 Output	0913								0977									
†	Entry/Exit 1	0914								0978									
	Entry/Exit 2	0915								0979									
†	Exit/Entry Follower	0916								0980									
†	Auto Reset	0917								0981									
†	Swinger Shutdown	0918								0982									
†	Chime	0919								0983									
	Abort Delay	0920								0984									
	Power-up Delay	0921								0985									
	Day Zone Open	0922								0986									
	Day Zone Short	0923								0987									
	Alarm on Day Zone	0924								0988									
†	Alarm Telco 1	0925								0989									
	Alarm Restore 1	0926								0990									
	Trouble Telco 1	0927								0991									
	Trouble Restore 1	0928								0992									
	Alarm Telco 3	0929								0993									
	Alarm Restore 3	0930								0994									
	Trouble Telco 3	0931								0995									
	Trouble Restore 3	0932								0996									
	No EOL Resistor	0933								0997									
	Trouble on Open	0934								0998									
	Trouble on Short	0935								0999									
†	Zone Area 1	0936								1000									
	Zone Area 2	0937								1001									
	Zone Area 3	0938								1002									
	Zone Area 4	0939								1003									
	Interior (Stay) Bypass	0940								1004									
	Keypad Sounder on Alarm	0941								1005									
†	2-Wire Smoke Detectors (B)	0942								1006									
†	Fire (C)	0943								1007									
	Fire Alarm Verification (C)	0944								1008									
	RESERVED	0945								1009									
	Zone ANDing Group 1	0946								1010									
	Zone ANDing Group 2	0947								1011									
	Zone ANDing Group 3	0948								1012									
	Zone ANDing Group 4	0949								1013									
	Sensor Watch	0950								1014									
	RESERVED	0951								1015									
	Chime 2	0952								1016									
	RESERVED	0953								1017									
	RESERVED	0954								1018									
	Carbon Monoxide	0955								1019									

For notes (A), (B), (C), †, +, ★, see page 30.

ZONE OPTIONS: Select zone options for any zone.

1. Select the desired zone option by entering the option number (1-8) for each selected zone.
2. Enter corresponding option number in address location.

NOTE: Dark shaded data value box shows option not available. Press **ENTER** to save.



ZONE OPTIONS - ZONES 17 TO 32 (ADDRESS 1029-1147)

ZONE FEATURES	ADDR	ZONES 17 → 24								ADDR	ZONES 25 → 32							
		Z17	Z18	Z19	Z20	Z21	Z22	Z23	Z24		Z25	Z26	Z27	Z28	Z29	Z30	Z31	Z32
		1	2	3	4	5	6	7	8		1	2	3	4	5	6	7	8
† + Priority	1029									1093								
Priority with Bypass	1030									1094								
Auto-Bypass	1031									1095								
† + Selective Bypass	1032									1096								
Keyswitch Arming	1033									1097								
Auto-Bypass Re-entry	1034									1098								
Pre-Alarm Warning	1035									1099								
Never Arm	1036									1100								
24-Hour Zone	1037									1101								
† + Alarm Output	1038									1102								
† Pulsed Alarm Output	1039									1103								
PGM1 Output	1040									1104								
PGM2 Output	1041									1105								
† Entry/Exit 1	1042									1106								
† Entry/Exit 2	1043									1107								
† Exit/Entry Follower	1044									1108								
† + Auto Reset	1045									1109								
† + Swinger Shutdown	1046									1110								
† Chime	1047									1111								
Abort Delay	1048									1112								
Power-up Delay	1049									1113								
Day Zone Open	1050									1114								
Day Zone Short	1051									1115								
Alarm on Day Zone	1052									1116								
† Alarm Telco 1	1053									1117								
Alarm Restore 1	1054									1118								
Trouble Telco 1	1055									1119								
Trouble Restore 1	1056									1120								
Alarm Telco 3	1057									1121								
Alarm Restore 3	1058									1122								
Trouble Telco 3	1059									1123								
Trouble Restore 3	1060									1124								
No EOL Resistor	1061									1125								
Trouble on Open	1062									1126								
Trouble on Short	1063									1127								
† Zone Area 1	1064									1128								
Zone Area 2	1065									1129								
Zone Area 3	1066									1130								
Zone Area 4	1067									1131								
Interior (Stay) Bypass	1068									1132								
Keypad Sounder on Alarm	1069									1133								
† Fire (C)	1071									1135								
Fire Alarm Verification (C)	1072									1136								
Zone ANDing Group 1	1074									1138								
Zone ANDing Group 2	1075									1139								
Zone ANDing Group 3	1076									1140								
Zone ANDing Group 4	1077									1141								
Sensor Watch	1078									1142								
RESERVED	1079									1143								
Chime 2	1080									1144								
RESERVED	1081									1145								
RESERVED	1082									1146								
Carbon Monoxide	1083									1147								

For programming instructions, see page 29.

- NOTES:**
- (A) 50ms Loop Response only available for zones 1-8. If Zone Doubling is enabled, Zones 9-16 will follow the loop response programming for Zones 1-8. For all other Zones, loop response is determined by jumpers on the GEM-EZM8 and/or keypad configuration on the GEMDK1CA or GEM-K1VFS.
 - (B) 2-wire Smoke Detectors only available for zones 7 & 8, and Fire must also be selected.
 - (C) If Fire Alarm Verification is selected, then Fire must also be selected.
 - + Enabled when "Enable SIA CP-01 Features?" is activated (Answer "Yes" in the EZ Programming Menu).
 - * Disabled when "Enable SIA CP-01 Features?" is activated (Answer "Yes" in the EZ Programming Menu). Disable Auto-Reset on non-fire zones for SIA CP-01 installations.
 - † When the Easy Program Menu is used, these features are enabled by default.

- DEFAULTS:** The zone options indicated are automatically set after exiting the Easy Menu Driven Mode.
- Priority, Selective Bypass, Alarm Output, Auto Reset, Swinger Shutdown and Zone Area 1 are enabled for the total number of zones entered in "## OF ZONES IN REPORT ENTER ## ZONES".
 - Alarm Telco 1 is enabled for the zone number(s) entered in "REPORT ALL ZONES TO INTERM. ZONES? Y/N".
 - Entry/Exit 1 and Chime are enabled for the zone number(s) entered in "ENTRY/EXIT ZONES ENTER ZONE #".
 - Exit/Entry Follower and Interior Bypass are enabled for the zone number(s) entered in "INTERIOR ZONES ENTER ZONE #".
 - Pulse Alarm Output is enabled for the zone number(s) entered in "PULSE ZONES ENTER ZONE #" or "PULSE FIRE ZMS ENTER ZONE #".
 - Fire is enabled for the zone number(s) entered in "FIRE ZONES ENTER ZONE #".
 - 2-Wire Smoke Detector is enabled for the zone number(s) entered in "2-WIRE FIRE ZMS ENTER ZONE #".

ZONE OPTIONS - ZONES 33 TO 48 (ADDRESS 1157-1275)

ZONE OPTIONS	ADDR	ZONES 33→ 40								ADDR	ZONES 41 → 48							
		Z33	Z34	Z35	Z36	Z37	Z38	Z39	Z40		Z41	Z42	Z43	Z44	Z45	Z46	Z47	Z48
		1	2	3	4	5	6	7	8		1	2	3	4	5	6	7	8
50ms Loop Response (A)																		
†→ Priority	1157									1221								
Priority with Bypass	1158									1222								
Auto-Bypass	1159									1223								
†→ Selective Bypass	1160									1224								
Keyswitch Arming	1161									1225								
Auto-Bypass Re-entry	1162									1226								
Pre-Alarm Warning	1163									1227								
Never Arm	1164									1228								
24-Hour Zone	1165									1229								
†→ Alarm Output	1166									1230								
† Pulsed Alarm Output	1167									1231								
PGM1 Output	1168									1232								
PGM2 Output	1169									1233								
† Entry/Exit 1	1170									1234								
Entry/Exit 2	1171									1235								
† Exit/Entry Follower	1172									1236								
†★ Auto Reset	1173									1237								
†★ Swinger Shutdown	1174									1238								
† Chime	1175									1239								
Abort Delay	1176									1240								
Power-up Delay	1177									1241								
Day Zone Open	1178									1242								
Day Zone Short	1179									1243								
Alarm on Day Zone	1180									1244								
† Alarm Telco 1	1181									1245								
Alarm Restore 1	1182									1246								
Trouble Telco 1	1183									1247								
Trouble Restore 1	1184									1248								
Alarm Telco 3	1185									1249								
Alarm Restore 3	1186									1250								
Trouble Telco 3	1187									1251								
Trouble Restore 3	1188									1252								
No EOL Resistor	1189									1253								
Trouble on Open	1190									1254								
Trouble on Short	1191									1255								
† Zone Area 1	1192									1256								
Zone Area 2	1193									1257								
Zone Area 3	1194									1258								
Zone Area 4	1195									1259								
Interior (Stay) Bypass	1196									1260								
Keypad Sounder on Alarm	1197									1261								
† 2-Wire Smoke Detectors (B)	1198									1262								
† Fire (C)	1199									1263								
Fire Alarm Verification (C)	1200									1264								
RESERVED	1201									1265								
Zone ANDing Group 1	1202									1266								
Zone ANDing Group 2	1203									1267								
Zone ANDing Group 3	1204									1268								
Zone ANDing Group 4	1205									1269								
Sensor Watch	1206									1270								
RESERVED	1207									1271								
Chime 2	1208									1272								
RESERVED	1209									1273								
RESERVED	1210									1274								
Carbon Monoxide	1211									1275								

For programming instructions, see page 29.

For notes (A), (B), (C), †, †, ★, see page 30.



ZONE OPTIONS - ZONES 49 TO 64 (ADDRESS 1285-1403)

	ZONE FEATURES	ADDR	ZONES 49 → 56								ADDR	ZONES 57 → 64							
			Z49	Z50	Z51	Z52	Z53	Z54	Z55	Z56		Z57	Z58	Z59	Z60	Z61	Z62	Z63	Z64
			1	2	3	4	5	6	7	8		1	2	3	4	5	6	7	8
†	Priority	1285									1349								
	Priority with Bypass	1286									1350								
	Auto-Bypass	1287									1351								
†	Selective Bypass	1288									1352								
	Keyswitch Arming	1289									1353								
	Auto-Bypass Re-entry	1290									1354								
	Pre-Alarm Warning	1291									1355								
	Never Arm	1292									1356								
	24-Hour Zone	1293									1357								
†	Alarm Output	1294									1358								
†	Pulsed Alarm Output	1295									1359								
	PGM1 Output	1296									1360								
	PGM2 Output	1297									1361								
†	Entry/Exit 1	1298									1362								
	Entry/Exit 2	1299									1363								
†	Exit/Entry Follower	1300									1364								
†	Auto Reset	1301									1365								
†	Swinger Shutdown	1302									1366								
†	Chime	1303									1367								
	Abort Delay	1304									1368								
	Power-up Delay	1305									1369								
	Day Zone Open	1306									1370								
	Day Zone Short	1307									1371								
	Alarm on Day Zone	1308									1372								
†	Alarm Telco 1	1309									1373								
	Alarm Restore 1	1310									1374								
	Trouble Telco 1	1311									1375								
	Trouble Restore 1	1312									1376								
	Alarm Telco 3	1313									1377								
	Alarm Restore 3	1314									1378								
	Trouble Telco 3	1315									1379								
	Trouble Restore 3	1316									1380								
	No EOL Resistor	1317									1381								
	Trouble on Open	1318									1382								
	Trouble on Short	1319									1383								
†	Zone Area 1	1320									1384								
	Zone Area 2	1321									1385								
	Zone Area 3	1322									1386								
	Zone Area 4	1323									1387								
	Interior (Stay) Bypass	1324									1388								
	Keypad Sounder on Alarm	1325									1389								
†	Fire (C)	1327									1391								
	Fire Alarm Verification (C)	1328									1392								
	Zone ANDing Group 1	1330									1394								
	Zone ANDing Group 2	1331									1395								
	Zone ANDing Group 3	1332									1396								
	Zone ANDing Group 4	1333									1397								
	Sensor Watch	1334									1398								
	RESERVED	1335									1399								
	Chime 2	1336									1400								
	RESERVED	1337									1401								
	RESERVED	1338									1402								
	Carbon Monoxide	1339									1403								

For programming instructions, see page 29.

For notes (A), (B), (C), †, +, ★, see page 30.



EXTERNAL RELAY CONTROL (ADDRESS 1489-1648)

ADDRESS 1489-1493 (RELAY EVENT 1)				
1489	1490	1491	1492	1493
RELAY #	AREA	TIMEOUT	EVENT ID	COND.

ADDRESS 1494-1498 (RELAY EVENT 2)				
1494	1495	1496	1497	1498
RELAY #	AREA	TIMEOUT	EVENT ID	COND.

ADDRESS 1499-1503 (RELAY EVENT 3)				
1499	1500	1501	1502	1503
RELAY #	AREA	TIMEOUT	EVENT ID	COND.

ADDRESS 1504-1508 (RELAY EVENT 4)				
1504	1505	1506	1507	1508
RELAY #	AREA	TIMEOUT	EVENT ID	COND.

ADDRESS 1509-1513 (RELAY EVENT 5)				
1509	1510	1511	1512	1513
RELAY #	AREA	TIMEOUT	EVENT ID	COND.

ADDRESS 1514-1518 (RELAY EVENT 6)				
1514	1515	1516	1517	1518
RELAY #	AREA	TIMEOUT	EVENT ID	COND.

ADDRESS 1519-1523 (RELAY EVENT 7)				
1519	1520	1521	1522	1523
RELAY #	AREA	TIMEOUT	EVENT ID	COND.

ADDRESS 1524-1528 (RELAY EVENT 8)				
1524	1525	1526	1527	1528
RELAY #	AREA	TIMEOUT	EVENT ID	COND.

ADDRESS 1529-1533 (RELAY EVENT 9)				
1529	1530	1531	1532	1533
RELAY #	AREA	TIMEOUT	EVENT ID	COND.

ADDRESS 1534-1538 (RELAY EVENT 10)				
1534	1535	1536	1537	1538
RELAY #	AREA	TIMEOUT	EVENT ID	COND.

ADDRESS 1539-1543 (RELAY EVENT 11)				
1539	1540	1541	1542	1543
RELAY #	AREA	TIMEOUT	EVENT ID	COND.

ADDRESS 1544-1548 (RELAY EVENT 12)				
1544	1545	1546	1547	1548
RELAY #	AREA	TIMEOUT	EVENT ID	COND.

ADDRESS 1549-1553 (RELAY EVENT 13)				
1549	1550	1551	1552	1553
RELAY #	AREA	TIMEOUT	EVENT ID	COND.

ADDRESS 1554-1558 (RELAY EVENT 14)				
1554	1555	1556	1557	1558
RELAY #	AREA	TIMEOUT	EVENT ID	COND.

ADDRESS 1559-1563 (RELAY EVENT 15)				
1559	1560	1561	1562	1563
RELAY #	AREA	TIMEOUT	EVENT ID	COND.

ADDRESS 1564-1568 (RELAY EVENT 16)				
1564	1565	1566	1567	1568
RELAY #	AREA	TIMEOUT	EVENT ID	COND.

ADDRESS 1569-1573 (RELAY EVENT 17)				
1569	1570	1571	1572	1573
RELAY #	AREA	TIMEOUT	EVENT ID	COND.

ADDRESS 1574-1578 (RELAY EVENT 18)				
1574	1575	1576	1577	1578
RELAY #	AREA	TIMEOUT	EVENT ID	COND.

ADDRESS 1579-1583 (RELAY EVENT 19)				
1579	1580	1581	1582	1583
RELAY #	AREA	TIMEOUT	EVENT ID	COND.

ADDRESS 1584-1588 (RELAY EVENT 20)				
1584	1585	1586	1587	1588
RELAY #	AREA	TIMEOUT	EVENT ID	COND.

ADDRESS 1589-1593 (RELAY EVENT 21)				
1589	1590	1591	1592	1593
RELAY #	AREA	TIMEOUT	EVENT ID	COND.

ADDRESS 1594-1598 (RELAY EVENT 22)				
1594	1595	1596	1597	1598
RELAY #	AREA	TIMEOUT	EVENT ID	COND.

ADDRESS 1599-1603 (RELAY EVENT 23)				
1599	1600	1601	1602	1603
RELAY #	AREA	TIMEOUT	EVENT ID	COND.

ADDRESS 1604-1608 (RELAY EVENT 24)				
1604	1605	1606	1607	1608
RELAY #	AREA	TIMEOUT	EVENT ID	COND.

ADDRESS 1609-1613 (RELAY EVENT 25)				
1609	1610	1611	1612	1613
RELAY #	AREA	TIMEOUT	EVENT ID	COND.

ADDRESS 1614-1618 (RELAY EVENT 26)				
1614	1615	1616	1617	1618
RELAY #	AREA	TIMEOUT	EVENT ID	COND.

ADDRESS 1619-1623 (RELAY EVENT 27)				
1619	1620	1621	1622	1623
RELAY #	AREA	TIMEOUT	EVENT ID	COND.

ADDRESS 1624-1628 (RELAY EVENT 28)				
1624	1625	1626	1627	1628
RELAY #	AREA	TIMEOUT	EVENT ID	COND.

ADDRESS 1629-1633 (RELAY EVENT 29)				
1629	1630	1631	1632	1633
RELAY #	AREA	TIMEOUT	EVENT ID	COND.

ADDRESS 1634-1638 (RELAY EVENT 30)				
1634	1635	1636	1637	1638
RELAY #	AREA	TIMEOUT	EVENT ID	COND.

ADDRESS 1639-1643 (RELAY EVENT 31)				
1639	1640	1641	1642	1643
RELAY #	AREA	TIMEOUT	EVENT ID	COND.

ADDRESS 1644-1648 (RELAY EVENT 32)				
1644	1645	1646	1647	1648
RELAY #	AREA	TIMEOUT	EVENT ID	COND.

**TO PROGRAM,
SEE NEXT PAGE**



[Default = blank (•) from address 1489-1648].



To program, follow the 5 steps below.

RELAY EVENT OPTIONS				
RELAY #	AREA	TIMEOUT	EVENT ID	COND.
See Step 1 below	See Step 2 below	See Step 3 below	See Step 4 below	See Step 5 below

STEP 1

RELAY # OPTIONS: The GEM-P1664 supports 16 external relays from Relay Module RM3008. Multiple events may be "mapped" to each relay, up to a maximum of 32 events.

Select the **relay number** from **Table 1** (next page); enter in corresponding address location.

STEP 2

AREA OPTIONS: Each relay event can be assigned to Area 1, 2, 3 and / or 4.

Select the **area** from **Table 2** (on next page); enter in corresponding address location.

STEP 3

TIMEOUTS: Each relay event can be assigned a timeout depending on Alarm Type option.

If Alarm Type is selected for timeout in minutes or seconds, enter the 3-digit **timeout duration** in corresponding address location. To choose seconds or minutes, see step 5A below. 254 is maximum entry.

STEP 4

EVENT ID CODES: Each relay event can be assigned any of the available event IDs from **Table 4**.

Select 2-digit **Event ID** from **Table 4** (on next page); enter in corresponding address locations (left and right digit).

STEP 5

RELAY EVENT CONDITION OPTIONS: Each relay event can be assigned an alarm type; and an activation condition; also, select a timeout type for each. Enter 5A in left area, enter 5B in right area.

5A. Select **Alarm Type** and **Timeout Type** from **Table 5A** (on next page); enter in corresponding left address location.

5B. Select **Activation Conditions** from **Table 5B** (on next page); enter in corresponding right address location.

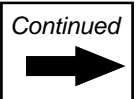

RELAY EVENT OPTIONS				
RELAY #	AREA	TIMEOUT	EVENT ID	COND.
See Table 1 below	See Table 2 below (right nibble)	Enter a Time period, in seconds or minutes	See Table 4 below	See Tables 5A & 5B below

DATA ENTRY		RELAY #
Left Nibble	Right Nibble	
blank (*)	blank (*)	NONE
blank (*)	1	1
blank (*)	2	2
blank (*)	3	3
blank (*)	4	4
blank (*)	5	5
blank (*)	6	6
blank (*)	7	7
blank (*)	8	8
blank (*)	9	9
blank (*)	0	10
blank (*)	B	11
blank (*)	C	12
blank (*)	D	13
blank (*)	E	14
blank (*)	F	15
1	blank (*)	16

DATA ENTRY	TURN OFF ON AREA DISARM
blank (*)	NONE
1	Area 1
2	Area 2
3	Area 1 & Area 2
4	Area 3
5	Area 1 & Area 3
6	Area 2 & Area 3
7	Areas 1, 2 & 3
8	Area 4
9	Area 1 & Area 4
0	Area 2 & Area 4
B	Areas 1, 2 & 4
C	Areas 3 & 4
D	Areas 1, 3 & 4
E	Areas 2, 3 & 4
F	Areas 1-4

RELAY EVENT ALARM TYPE OPTIONS		
LEFT DATA ENTRIES	ALARM TYPE	TIMEOUT TYPE
blank (*)	Burglary	Minutes
1	Fire	Minutes
4	Day Zone	Minutes
8	Burglary	Seconds
9	Fire	Seconds
C	Day Zone	Seconds

RELAY EVENT ACTIVATION CONDITIONS	
RIGHT DATA ENTRIES	OPTIONS
1	Alarm
2	Restore
3	Trouble
4	Trouble Restore
5	Follow Zone

EVENT ID CODES		
DATA ENTRIES		OPTION
LEFT	RIGHT	
blank (*)	blank (*)	Area 1 Arm
blank (*)	1	Area 2 Arm
blank (*)	2	Area 3 Arm
blank (*)	3	Area 4 Arm
blank (*)	8	Zone 1
blank (*)	9	Zone 2
blank (*)	0	Zone 3
blank (*)	B	Zone 4
blank (*)	C	Zone 5
blank (*)	D	Zone 6
blank (*)	E	Zone 7
blank (*)	F	Zone 8
1	blank (*)	Zone 9
1	1	Zone 10
1	2	Zone 11
1	3	Zone 12
1	4	Zone 13
1	5	Zone 14
1	6	Zone 15
1	7	Zone 16
1	8	Zone 17
1	9	Zone 18
1	0	Zone 19
1	B	Zone 20
1	C	Zone 21
1	D	Zone 22
1	E	Zone 23
1	F	Zone 24
2	blank (*)	Zone 25
2	1	Zone 26
2	2	Zone 27
2	3	Zone 28
2	4	Zone 29
2	5	Zone 30
2	6	Zone 31
2	7	Zone 32
2	8	Zone 33
2	9	Zone 34
2	0	Zone 35
2	B	Zone 36
2	C	Zone 37

EVENT ID CODES		
DATA ENTRIES		OPTION
LEFT	RIGHT	
2	D	Zone 38
2	E	Zone 39
2	F	Zone 40
3	blank (*)	Zone 41
3	1	Zone 42
3	2	Zone 43
3	3	Zone 44
3	4	Zone 45
3	5	Zone 46
3	6	Zone 47
3	7	Zone 48
3	8	Zone 49
3	9	Zone 50
3	0	Zone 51
3	B	Zone 52
3	C	Zone 53
3	D	Zone 54
3	E	Zone 55
3	F	Zone 56
4	blank (*)	Zone 57
4	1	Zone 58
4	2	Zone 59
4	3	Zone 60
4	4	Zone 61
4	5	Zone 62
4	6	Zone 63
4	7	Zone 64
6	8	Area 1 KP Ambush
6	9	Area 1 KP Panic
6	0	Area 1 KP Fire
6	B	Area 1 KP Aux †
6	C	Area 1 KP Tamper
6	D	Area 1 Fail to Open
6	E	Area 1 Fail to Close
7	blank (*)	Area 2 KP Ambush
7	1	Area 2 KP Panic
7	2	Area 2 KP Fire
7	3	Area 2 KP Aux †
7	4	Area 2 KP Tamper
7	5	Area 2 Fail to Open
7	6	Area 2 Fail to Close

EVENT ID CODES		
DATA ENTRIES		OPTION
LEFT	RIGHT	
7	8	Area 3 KP Ambush
7	9	Area 3 KP Panic
7	0	Area 3 KP Fire
7	B	Area 3 KP Aux †
7	C	Area 3 KP Tamper
7	D	Area 3 Fail to Open
7	E	Area 3 Fail to Close
7	F	Area 4 KP Ambush
8	1	Area 4 KP Panic
8	2	Area 4 KP Fire
8	3	Area 4 KP Aux †
8	4	Area 4 KP Tamper
8	5	Area 4 Fail to Open
8	6	Area 4 Fail to Close
0	8	Test Timer
0	B	Memory Fail
0	C	Low Battery
0	D	AC Fail
0	E	EZM Tamper
0	F	Alarm Supervisory
B	5	RF Receiver Trouble (Tamper/Fail)
B	6	Wireless TX Tamper
B	7	Wireless TX Trouble (LB/Supervisory)
C	8	Area 1 Arming AWAY
C	9	Area 2 Arming AWAY
C	0	Area 3 Arming AWAY
C	B	Area 4 Arming AWAY
D	blank (*)	Keypad Fail
D	1	EZM Fail
D	2	Quickloader Device Control
D	5	General System Alarm
D	8	Area 1 General System Alarm
D	9	Area 2 General System Alarm
D	0	Area 3 General System Alarm
D	B	Area 4 General System Alarm
F	blank (*)	Relay Control Group 1
F	1	Relay Control Group 2
F	8	Entry Relay Area 1
F	9	Entry Relay Area 2
F	0	Entry Relay Area 3
F	B	Entry Relay Area 4

†NOTE: Keypad Auxiliary is not to be selected for UL Installations.
NOTE: Keypad Tamper must be enabled in UL installations.



RF RECEIVER & SUPERVISORY TIMER OPTIONS (ADDRESS 2029-2044 & 2056)

Number of RF Receivers	ADDRESS 2056	
	LEFT DIGIT	RIGHT DIGIT
	blank (*)	

DATA ENTRIES	RF RECEIVER(S)
blank (*)	None
1	1
2	2

RF RECEIVERS: Up to 2 RF Receivers may be programmed.

1. Select the number of receivers from the table shown.
2. Enter number in address location shown.
3. Press  to save.

Default for Number of Receivers depends on Easy Menu Question for RF Transmitters.

RF SUPERVISORY TIMERS: RF Supervisory Timers may be programmed for each type of transmitter used. A transmitter will send a transmission every time it is tripped, when there is NO activity, the transmitter sends a status transmission about once an hour. If the receiver does NOT receive ANY signal (a trip or a status) from a transmitter in the time specified for transmitter type, a system trouble "WIRELESS TROUBLE/E04-NN SERVICE" will be displayed at the keypad.

1. Select timer delay from the table shown. Timers are programmed in increments of 30 minutes each. Valid entries are [3] through [F] (90 minutes-450 minutes).
2. Enter in corresponding address locations below (right nibble).
3. Press  to save.

RF SUPERVISORY TIMER	RF TRANSMITTER	ADDR	RF SUPERVISORY DELAY TIME (Select timer delay from the table at right)
Type 0	Window/Door, 2 Pt.	2029	
Type 1	Window/Door, 2 Pt.	2030	
Type 2	Window/Door, 2 Pt.	2031	
Type 3	Window/Door, 2 Pt.	2032	
Type 4	RESERVED		
Type 5	PIR	2034	
Type 6	PIR	2035	
Type 7	Smoke Detector	2036	
Type 8	Smoke Detector	2037	
Type 9	RESERVED		
Type A	Dual Tech.	2039	
Type B	RESERVED		
Type C	Window/Door, 4 Pt.	2041	
Type D	PIR	2042	
Type E	Smoke Detector	2043	
Type F	Napco Glass Break	2044	

RF SUPERVISORY TIMERS	
DATA ENTRIES	DELAY
3	90 min.
4	120 min.
5	150 min.
6	180 min.
7	210 min.
8	240 min.
9	270 min.
0	300 min.
B	330 min.
C	360 min.
D	390 min.
E	420 min.
F	450 min.

[Default = blank (*) from address 2029-2044]. Default = 8 (240 minutes)

NOTE: These timers apply only to Supervised RF Transmitters (see RF Transmitters in Easy Menu Driven Mode Pro-

CLEAR PROGRAM OPTIONS (ADDRESS 2285 & 2286)

2285 XX	H
---------	---

Clear Dealer Program (Erases Dealer Program)



This *erases the dealer program*. Use this feature to start a customized default program. Program Data and System Status Memory is erased where Scheduled Data and Zone Descriptions are maintained.

Access address 2285, then press . Data entry is not allowed.

NOTE: Enter Easy Menu Driven Program Mode to program system again.

2286 XX	H
---------	---

Cold Start (Erases Entire Program)



This erases the entire program including Dealer Program by erasing Program Data, Zone Description Data and System Status Data (similar to a new panel).







Access address 2286, then press . Data entry is not allowed.

NOTE: Some features (schedules) can only be programmed again with the Downloading Software. If power fails, time and date restarts at 00:00:00 and a date of 01-01-04 (January 1, 2004).

USER PROGRAM MODE

PRELIMINARY INFORMATION

The User Program Mode is covered in detail in the operating instructions for the keypad in use.

-  The Program Mode cannot be accessed while the communicator is transmitting except during the first three minutes after power-up.
-  After entering codes or data, press the save  button. *Data will not be stored into memory unless this button is pressed.*
-  If the keypad is in the Program Mode and no activity is detected for longer than 4 minutes, a steady tone will sound.
-  Press the  button to silence the sounder and exit the User Program Mode.

ACCESSING USER PROGRAM MODE

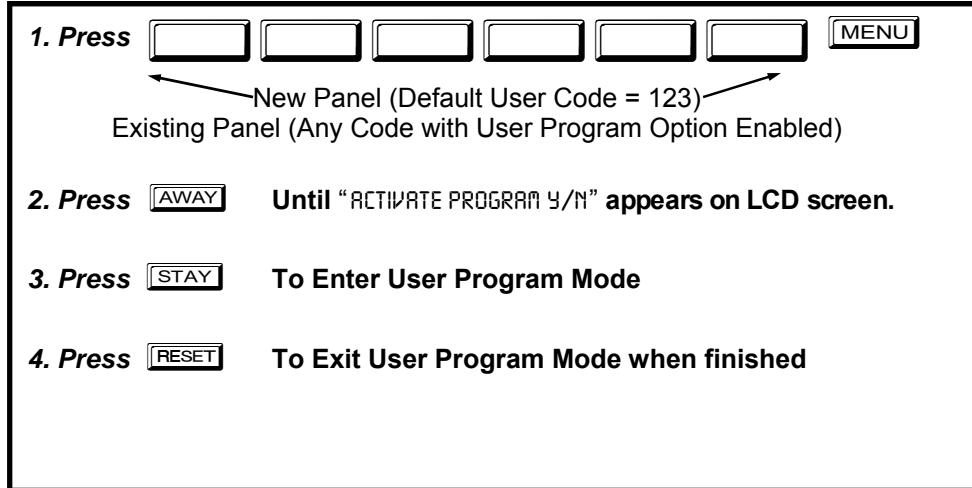

USER CODES

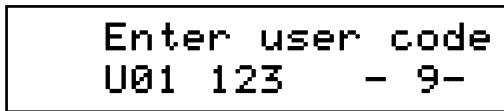

Keypad (Direct Entry)

Up to 64 User Codes may be programmed.
NOTE: In this mode, only the code is programmable; the accompanying Area Options must be programmed in the Dealer Program Mode (see page 5).

☞ Use the [MENU] button to place the cursor over the User Number.

☞ Enter a User Number (01-8) using the number buttons. The cursor will then advance to the User Code and read the existing code, if any.

☞ Enter the new User Code using the number buttons (0-9). If an old code is displayed, program over it. To erase the digit at the cursor, press [*] [0] button.

☞ Press the [ENTER] button to save the code in memory.

☞ Repeat this procedure for each user. To proceed to Zone-Description programming, press the NEXT/YES button or the PRIOR/NO button.

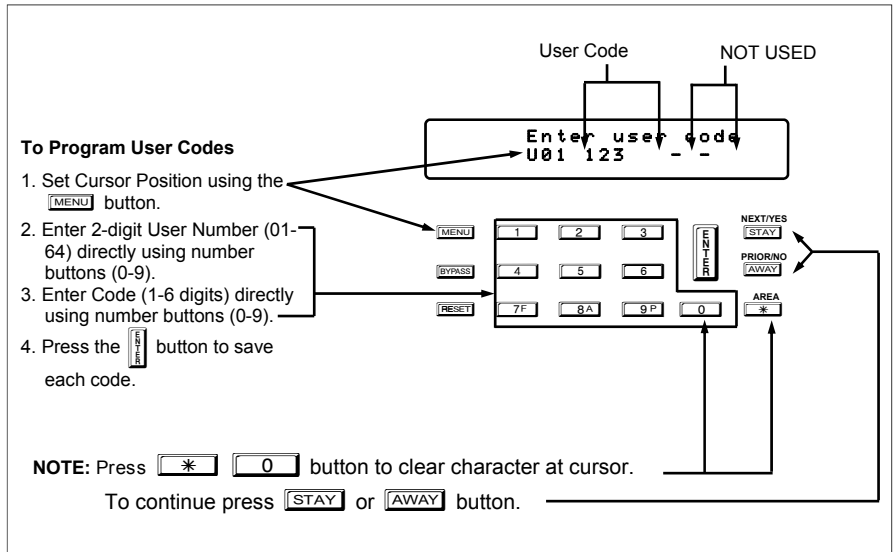

Programming User Codes with a Keypad

ZONE DESCRIPTIONS (USING A KEYPAD)

01-

Enter an identifying description for each zone. Characters are selected by pressing keypad buttons multiple times, "Cell Phone" style. Buttons through plus and are used, as per the following table:

PRESS:	CHARACTERS DISPLAYED IN SEQUENCE	HOLD AND PRESS:	CHARACTERS DISPLAYED IN SEQUENCE
	ABC1		abc1
	DEF2		def2
	GHI3		ghi3
	JKL4		jkl4
	MNO5		mno5
	PQR6		pqr6
	STU7		stu7
	VWX8		vwx8
	YZ90		yz90
	(SPACE) * . () , / : ? #		(Reserved)

Press to move cursor right.

Press to move cursor left.

Notes:

- After releasing the number button for 2 seconds, the character will be accepted and the cursor advanced to the right.
- After releasing the number button, if a new number button is pressed before the 2 second window expires, the current character will be accepted and the cursor automatically advanced to the right. The first of the 4 characters of this new number button will be displayed.
- To erase an existing entry, use or to move the cursor below the character to be changed. Enter a new character to overwrite the old, or press zero to delete the character.
- To generate lowercase characters, the button must be pressed and held down while pressing the number button. If the button is released during the 2 second window, the current character will change to uppercase.

Press to save.

To advance to the next zone (or to any other zone), move the cursor to the displayed zone number (i.e., "01") using and . Change the zone number using keys through . Enter two digits for the zone number (after entering the first digit, the cursor will automatically advance to the second digit). When the second zone number digit is entered, the cursor will automatically advance to the right, allowing the description locations to be entered. Always press to save each zone description.

Enter Date

< / / >

(Direct Entry)

Enter Date (Press the button to set cursor.)

Enter the current date in the format MM/DD/YY, where MM = the month (01–12); DD=the day (01–31); and YY=the year. Press to save. Press NEXT button to proceed.

Enter Time

< : >

(Direct Entry)

Enter Time (Press the button to set cursor.)

Enter the current time in the format HH:MMA/P, where HH=hours (01–12); MM=minutes (00–59). Select AM or PM by pressing any number button, then press

once again to save.

NOTE: To enter the date and time, "Enable Keypad Time/Date Display" (Address 1420) must be enabled.



KEYPAD CONFIGURATION MODE

This section will focus on configuring the GEM-K1VPS and GEM-DK1CA keypads.

KEYPAD INSTALLATION

Each keypad must be assigned an address number (1–7) and each requires its own configuration procedure (see **CONFIGURING THE KEYPADS**, which follows). At least 1 keypad must be used; only 1 is required for a single-area Commercial Burglary installation.

CONFIGURING THE KEYPADS

A total of up to 7 keypads may be connected to the panel. Each keypad must be configured for (a) keypad tactile beep; (b) entry sounder; (c) keypad address; (d) compatibility number; (e) EZM address; and (f) zone response.

To enter the Keypad Configuration Mode:

NORMAL
KEYPAD
CONFIGURE



1. Move jumper JP1 (located in the center of the control panel board) from Pins 1-2 (top two) to Pins 2-3 (bottom two). **NOTE:** See Wiring Diagram at the end of this manual.
2. After about 15 seconds, the display will read "XX OUT OF SYSTEM", where XX indicates the keypad address.
3. Press and proceed as follows. (Repeat the following procedure for all keypads).

Keypad Beep ON

Keypad Tactile Beep

Upon entering the Keypad Configuration Mode, "KEYPAD BEEP ON" will be displayed, indicating that the tactile beep, which sounds when any button is pressed, is on. To turn off the tactile beep, press the button (the button will toggle the tactile beep on and off). Press to continue or press to exit.

Entry Sounder ON

Entry Sounder

To turn off the keypad entry sounder during entry time, press (the button will toggle the entry sounder on and off). Press to continue or press to exit.

Keypad Address 01

Keypad Address

If more than one keypad is installed, each must be assigned a unique keypad address (that is, no two keypads may be numbered alike):

Keypads must be numbered consecutively (missing numbers are not permitted)

To assign the keypad number, proceed as follows:

1. Enter the assigned keypad number 01–07, then press to save. A valid number will be acknowledged by a short beep; an invalid number will be rejected by a long beep.
2. Press to continue or press to exit.

New
Compat # 0000

Compatibility Number (Not Applicable)

THIS FEATURE IS NOT COMPATIBLE WITH THE GEM-P1664 CONTROL PANEL. **DO NOT CHANGE THIS SETTING.**

Press the **MENU** button to continue or press the **RESET** button to exit.

EZM Address 01

EZM Address

The keypad's internal EZM (Expansion Zone Module) may be utilized to provide four additional wired zones. Whether used alone or in conjunction with optional GEM-EZM series modules or other keypad EZMs, it must be assigned a unique address (or Group number, see Keypad Programming

Workbook) similar to its keypad address. If no other EZMs are to be used, designate the keypad as Group "01" at the "EZM ADDRESS 00" display. In multiple-EZM systems, enter an assigned group number "01" through "14". (Each EZM must have a unique assigned group number, starting with "01" and proceeding consecutively.) Press the **MENU** button to continue or press the **RESET** button to exit.

Zone Response 00

Zone Response

The normal loop response of each keypad expansion zone is 750mS, however the response time of any zone can be reduced to 50mS as follows.

1. Of the following, circle the number(s) in parentheses associated with the zone(s) to be changed: Zone 1=(1); Zone 2=(2); Zone 3=(4); Zone 4=(8)

2. Add up the circled numbers.

3. At the keypad, enter the sum as a two-digit number "01" through "15" on the display, then press **ENTER**.

Example. Change Zones 2, 3 and 4 to 50mS response.

1. Circle numbers for Zones 2, 3 and 4: (2), (4) and (8).

2. Add up the circled numbers: $2 + 4 + 8 = 14$.

3. Enter "14" at the keypad, then press the **ENTER** button.

Press the **MENU** button to continue or press the **RESET** button to exit.

Program Control
Message # ?

Program Control Message (Not Applicable)

THIS FEATURE IS NOT COMPATIBLE WITH THE GEM-P1664 CONTROL PANEL. **DO NOT CHANGE THIS SETTING.**

Press the **MENU** button to continue (the display will loop back through selections, for changes) or press the **RESET** button to exit the Keypad Configuration Mode (display will read "01 OUT OF SYSTEM"). Then replace Jumper JP1 across Pins 1-2 (top two).

EASY MENU PROGRAMMING WORKSHEET - 2 OF 4

RF Transmitter Points:

XMTR #	ZONE #	RF ID (printed on xmtr box)				CHECK SUM	POINT #
1							
2							
3							
4							
5							
6							
7							
8							
9							
10							
11							
12							
13							
14							
15							
16							

XMTR #	ZONE #	RF ID (printed on xmtr box)				CHECK SUM	POINT #
17							
18							
19							
20							
21							
22							
23							
24							
25							
26							
27							
28							
29							
30							
31							
32							

XMTR #	ZONE #	RF ID (printed on xmtr box)				CHECK SUM	POINT #
33							
34							
35							
36							
37							
38							
39							
40							
41							
42							
43							
44							
45							
46							
47							
48							

XMTR #	ZONE #	RF ID (printed on xmtr box)				CHECK SUM	POINT #
49							
50							
51							
52							
53							
54							
55							
56							
57							
58							
59							
60							
61							
62							
63							
64							

Key Fob Transmitters:

KEY FOB #	Area	RF ID (printed on xmtr box)				CHECK SUM	OPTION 1	OPTION 2
1								
2								
3								
4								
5								
6								
7								
8								



EASY MENU PROGRAMMING WORKSHEET - 3 OF 4

Zone Descriptions 1-32

ZN #	CHARACTERS AVAILABLE (See below)																												
	1	2	3	4	5	6	7	8	9	10	11	12	13	14	15	16	17	18	19	20	21	22	23	24	25	26	27	28	29
1																													
2																													
3																													
4																													
5																													
6																													
7																													
8																													
9																													
10																													
11																													
12																													
13																													
14																													
15																													
16																													
17																													
18																													
19																													
20																													
21																													
22																													
23																													
24																													
25																													
26																													
27																													
28																													
29																													
30																													
31																													
32																													

Characters Available for Zone Descriptions
 !@#\$%^&*()_+!|{|[]`.,.<>?
 1234567890
 abcdefghijklmnopqrstuvwxyz
 ABCDEFGHIJKLMNOPQRSTUVWXYZ

Dealer Code:

For Zones 33-64,
see next page



EASY MENU PROGRAMMING WORKSHEET - 4 OF 4

Zone Descriptions 33-64

ZN #	CHARACTERS AVAILABLE (See below)																													
	1	2	3	4	5	6	7	8	9	10	11	12	13	14	15	16	17	18	19	20	21	22	23	24	25	26	27	28	29	
33																														
34																														
35																														
36																														
37																														
38																														
39																														
40																														
41																														
42																														
43																														
44																														
45																														
46																														
47																														
48																														
49																														
50																														
51																														
52																														
53																														
54																														
55																														
56																														
57																														
58																														
59																														
60																														
61																														
62																														
63																														
64																														

Characters Available for Zone Descriptions
 ! @ # \$ % ^ & * () _ + ! | | { } [] ` , . < > ?
 1 2 3 4 5 6 7 8 9 0
 a b c d e f g h i j k l m n o p q r s t u v w x y z
 A B C D E F G H I J K L M N O P Q R S T U V W X Y

For Zones 1-32,
 see previous
 ← page

Dealer Code:



ALPHABETICAL INDEX

1400HZ HANDSHAKE/KISSOFF, ADDRESS 0461.....	20
1400HZ HANDSHAKE/KISSOFF, ADDRESS 0483.....	20
1400HZ HANDSHAKE/KISSOFF, ADDRESS 0505.....	20
2300HZ HANDSHAKE/KISSOFF, ADDRESS 0461.....	20
2300HZ HANDSHAKE/KISSOFF, ADDRESS 0483.....	20
2300HZ HANDSHAKE/KISSOFF, ADDRESS 0505.....	20
24 HOUR AUXILIARY (MODEM CODE)	23
24 HOUR ZONES IN AREA 1	6
24-HOUR ZONE (ZONE OPTION), ADDRESS 0909, 0973.....	29
24-HOUR ZONE (ZONE OPTION), ADDRESS 1037, 1101.....	30
24-HOUR ZONE (ZONE OPTION), ADDRESS 1165, 1229.....	31
24-HOUR ZONE (ZONE OPTION), ADDRESS 1293, 1357.....	32
2-WIRE FIRE ZONES IN AREA 1.....	6
2-WIRE SMOKE DETECTORS (ZONE OPTION), ADDRESS 0942.....	29
2-WIRE SMOKE DETECTORS (ZONE OPTION), ADDRESS 1198, 1262.....	31
3/1 WITH EXTENDED RESTORES, ADDRESS 0461	20
3/1 WITH EXTENDED RESTORES, ADDRESS 0483	20
3/1 WITH EXTENDED RESTORES, ADDRESS 0505	20
50MS LOOP RESPONSE (ZONE OPTION), ADDRESS 0900, 0964	29
50MS LOOP RESPONSE ZONES.....	7
ABORT DELAY (ZONE OPTION), ADDRESS 0920, 0984	29
ABORT DELAY (ZONE OPTION), ADDRESS 1048, 1112	30
ABORT DELAY (ZONE OPTION), ADDRESS 1176, 1240	31
ABORT DELAY (ZONE OPTION), ADDRESS 1304, 1368	32
ABORT DELAY, ADDRESS 1417	15
AC FAIL REPORT DELAY, ADDRESS 1419	15
ACCESS	
AREA OPTION	9
ACCESS CONTROL ON PGM2 OUTPUT, ADDRESS 1421	19
ACCESSING DEALER PROGRAM MODE.....	5
ACTIVATE DOWNLOAD FUNCTION	4
ADDRESS DISPLAYS	
TYPES.....	11
ADDRESS MODE DISPLAYS	11
ADEMCO POINT ID (CS RECEIVER 1 FORMAT)	20
ADEMCO SLOW, SILENT KNIGHT SLOW (CS RECEIVER 1 FORMAT).....	20
ALARM ON DAY ZONE (ZONE OPTION), ADDRESS 0924, 0988.....	29
ALARM ON DAY ZONE (ZONE OPTION), ADDRESS 1052, 1116.....	30
ALARM ON DAY ZONE (ZONE OPTION), ADDRESS 1180, 1244.....	31
ALARM ON DAY ZONE (ZONE OPTION), ADDRESS 1308, 1372.....	32
ALARM OUTPUT (ZONE OPTION), ADDRESS 0910, 0974	29
ALARM OUTPUT (ZONE OPTION), ADDRESS 1038, 1102	30
ALARM OUTPUT (ZONE OPTION), ADDRESS 1166, 1230	31
ALARM OUTPUT (ZONE OPTION), ADDRESS 1294, 1358	32
ALARM OUTPUT SUPERV., ADDRESS 0689	22
ALARM OUTPUT TIMEOUT, ADDRESS 1414	16
ALARM OUTPUT, ADDRESS 0836	17
ALARM OUTPUT, ADDRESS 0857	17
ALARM OUTPUT, ADDRESS 0865	17
ALARM OUTPUT, ADDRESS 0873	18
ALARM OUTPUT, ADDRESS 0881	18
ALARM RESTORE 1 (ZONE OPTION), ADDRESS 0926, 0990	29
ALARM RESTORE 1 (ZONE OPTION), ADDRESS 1054, 1118	30
ALARM RESTORE 1 (ZONE OPTION), ADDRESS 1182, 1246	31
ALARM RESTORE 1 (ZONE OPTION), ADDRESS 1310, 1374	32
ALARM RESTORE 3 (ZONE OPTION), ADDRESS 0930, 0994	29
ALARM RESTORE 3 (ZONE OPTION), ADDRESS 1058, 1122	30
ALARM RESTORE 3 (ZONE OPTION), ADDRESS 1186, 1250	31
ALARM RESTORE 3 (ZONE OPTION), ADDRESS 1314, 1378	32
ALARM RESTORE, ADDRESS 0670	22
ALARM TELCO 1 (ZONE OPTION), ADDRESS 0925, 0989.....	29
ALARM TELCO 1 (ZONE OPTION), ADDRESS 1053, 1117.....	30
ALARM TELCO 1 (ZONE OPTION), ADDRESS 1181, 1245.....	31
ALARM TELCO 1 (ZONE OPTION), ADDRESS 1309, 1373.....	32
ALARM TELCO 3 (ZONE OPTION), ADDRESS 0929, 0993.....	29
ALARM TELCO 3 (ZONE OPTION), ADDRESS 1057, 1121.....	30
ALARM TELCO 3 (ZONE OPTION), ADDRESS 1185, 1249.....	31
ALARM TELCO 3 (ZONE OPTION), ADDRESS 1313, 1377.....	32
AMBUSH	
AREA OPTION	9
AMBUSH, ADDRESS 0698	22
AREA ARMING OPTIONS (ADDRESS 1469-1472).....	25
AREA BELL CONTROL OPTIONS (ADDRESS 1473-1488)	26
ARM ONLY	
AREA OPTION	9
ARM/DISARM	
AREA OPTION	9
AUTO BELL TEST ON ARMING, ADDRESS 1421	19
AUTO BYPASS RE-ENTRY ZONES	7
AUTO RESET (ZONE OPTION), ADDRESS 0917, 0981.....	29
AUTO RESET (ZONE OPTION), ADDRESS 1045, 1109.....	30
AUTO RESET (ZONE OPTION), ADDRESS 1173, 1237.....	31
AUTO RESET (ZONE OPTION), ADDRESS 1301, 1365.....	32
AUTO RESET AFTER BURGLARY OUTPUT TIMEOUT, ADDRESS 1421	19
AUTO-BYPASS (ZONE OPTION), ADDRESS 0903, 0967	29
AUTO-BYPASS (ZONE OPTION), ADDRESS 1031, 1095.....	30
AUTO-BYPASS (ZONE OPTION), ADDRESS 1159, 1223.....	31
AUTO-BYPASS (ZONE OPTION), ADDRESS 1287, 1351.....	32
AUTO-BYPASS RE-ENTRY (ZONE OPTION), ADDRESS 0906, 0970	29
AUTO-BYPASS RE-ENTRY (ZONE OPTION), ADDRESS 1034, 1098	30
AUTO-BYPASS RE-ENTRY (ZONE OPTION), ADDRESS 1162, 1226	31
AUTO-BYPASS RE-ENTRY (ZONE OPTION), ADDRESS 1290, 1354	32
AUTOMATIC INTERIOR BYPASS/EASY EXIT, ADDRESS 1424.....	19
AUX OUTPUT ACTIVATED ON ALARM ZONES.....	7
AUXILIARY ALARM (MODEM CODE).....	23
AUXILIARY, ADDRESS 0701	22
BACKUP REPORT ON TELCO 1 & 2, ADDRESS 0788	22
BINARY (BIT) FORMAT EXAMPLE	11
BIT FORMAT	
EXAMPLE	11
BURGLARY (MODEM CODE).....	23
BURGLARY OUTPUT TURNS OFF UPON DISARM, ADDRESS 1473.....	26
BURGLARY OUTPUT TURNS OFF UPON DISARM, ADDRESS 1474.....	26
BURGLARY OUTPUT TURNS OFF UPON DISARM, ADDRESS 1475.....	26
BURGLARY OUTPUT TURNS OFF UPON DISARM, ADDRESS 1476.....	26
BYPASS ENABLE	
AREA OPTION	9
CALLBACK METHOD	4
CALLBACK TELEPHONE NUMBER, ADDRESS 0526-0545.....	16
CANCEL A CODE.....	9
CANCEL NEXT TEST TIMER ON ANY REPORT, ADDRESS 0788	22
CANCEL, ADDRESS 0681	22
CARBON MONOXIDE (ZONE OPTION).....	29-32
CENTRAL STATION RECEIVER 1 ACCOUNT NUMBER	8
CENTRAL STATION RECEIVER 1 FORMAT.....	8
CENTRAL STATION RECEIVER 1 TELEPHONE NUMBER	8
CHANGE PULSE OUTPUT TO TEMPORAL OUTPUT, ADDRESS 1422	19
CHANGING OR CANCELING A CODE.....	9
CHIME (ZONE OPTION), ADDRESS 0919, 0983.....	29
CHIME (ZONE OPTION), ADDRESS 1047, 1111.....	30
CHIME (ZONE OPTION), ADDRESS 1175, 1239.....	31
CHIME (ZONE OPTION), ADDRESS 1303, 1367.....	32
CHIME 2 (ZONE OPTION), ADDRESS 0952, 1016	29
CHIME 2 (ZONE OPTION), ADDRESS 1080, 1144	30

ALPHABETICAL INDEX (CONT'D)

CHIME 2 (ZONE OPTION), ADDRESS 1208, 1272.....	31
CHIME 2 (ZONE OPTION), ADDRESS 1336, 1400.....	32
CHIME 2 ZONES IN AREA 1.....	7
CHIME TIME, ADDRESS 1418.....	15
CHIME ZONES IN AREA 1.....	7
CHIRP OUTPUT ON KEYFOB ARM/DISARM, ADDRESS 1422.....	19
CLEAR DEALER PROGRAM	
EASY MENU.....	10
CLEAR DEALER PROGRAM, ADDRESS 2285.....	37
CLOSING REPORT.....	24
CLOSING REPORT ONLY ON CONDITIONAL CLOSE, ADDRESS 1420.....	19
CLOSING, ADDRESS 0678.....	22
COLD START	
EASY MENU.....	10
COLD START, ADDRESS 2286.....	37
COMPATIBILITY NUMBER.....	41
CONDITIONAL CLOSE, ADDRESS 0680.....	22
CONFIGURING THE KEYPADS.....	40
CONTROL PANEL FIRMWARE VERSION.....	2
CREATE A CUSTOM PROGRAM.....	6
CS AREA & SYSTEM REPORTING OPTIONS (ADDRESS 0785, 0786 & 0788).....	22
CS RECEIVER 1 FORMAT, ADDRESS 0460.....	20
CS RECEIVER 1 TELEPHONE NUMBER, ADDRESS 0462-0481.....	20
CS RECEIVER 2 FORMAT, ADDRESS 0482.....	20
CS RECEIVER 2 TELEPHONE NUMBER, ADDRESS 0484-0503.....	20
CS RECEIVER 3 FORMAT, ADDRESS 0504.....	20
CS RECEIVER 3 TELEPHONE NUMBER, ADDRESS 0506-0525.....	20
CS RECEIVER OPTIONS - TELCO 1, ADDRESS 0461.....	20
CS RECEIVER OPTIONS - TELCO 2, ADDRESS 0483.....	20
CS RECEIVER OPTIONS - TELCO 3, ADDRESS 0505.....	20
CS SUBSCRIBER ID OPTIONS (ADDRESS 0560-0667).....	21
CS SYSTEM REPORT OPTIONS, ADDRESS 0788.....	22
CS SYSTEM REPORTING CODES, ADDRESS 0683-0708.....	22
CS TELCO SUBSCRIBER ID NUMBERS.....	21
CS USER REPORTING OPTIONS (ADDRESS 0800-0835).....	24
CS ZONE REPORTING OPTIONS (ADDRESS 0720-0783).....	23
CURRENT TIME.....	10
CUSTOM DEFAULT PROGRAM.....	5
CUSTOMIZING A DEFAULT PROGRAM.....	5
DATE.....	10
DAY ZONE OPEN (ZONE OPTION), ADDRESS 0922, 0986.....	29
DAY ZONE OPEN (ZONE OPTION), ADDRESS 1050, 1114.....	30
DAY ZONE OPEN (ZONE OPTION), ADDRESS 1178, 1242.....	31
DAY ZONE OPEN (ZONE OPTION), ADDRESS 1306, 1370.....	32
DAY ZONE SHORT (ZONE OPTION), ADDRESS 0923, 0987.....	29
DAY ZONE SHORT (ZONE OPTION), ADDRESS 1051, 1115.....	30
DAY ZONE SHORT (ZONE OPTION), ADDRESS 1179, 1243.....	31
DAY ZONE SHORT (ZONE OPTION), ADDRESS 1307, 1371.....	32
DEALER CODE.....	10
DEFAULT.....	5
DEALER PROGRAM - PRELIMINARY INFORMATION.....	5
DEALER PROGRAM MODE.....	4
DEALER PROGRAM MODE	
ACCESSING.....	5
DECIMAL FORMAT.....	12
EXAMPLE.....	12
DECIMAL FORMAT EXAMPLE.....	12
DEFAULT DEALER CODE.....	5
DIGITAL DIALER RPT ENTER/EXIT TEST MODE, ADDRESS 2053.....	19
DIRECT ADDRESS OVERVIEW.....	11
DIRECT ADDRESS PROGRAM MODE.....	4
DIRECT ADDRESS PROGRAM MODE.....	11
DISABLE [ON/OFF] AS EASY EXIT, ADDRESS 2051.....	19
DISABLE 2ND CALL ANS. MACHINE OVERRIDE, ADDRESS 1424.....	19
DISABLE AUTO DIAL TONE DETECT, ADDRESS 0788.....	22
DISABLE CALL WAITING ON 1ST ATTEMPT, ADDRESS 2053.....	19
DISABLE CALLBACK DOWNLOAD, ADDRESS 1422.....	19
DISABLE CLOSING REPORTS, ADDRESS 0786.....	22
DISABLE CODE REQUIRED FOR EZ BYPASS, ADDRESS 1424.....	19
DISABLE KEYPAD FUNCTION MODE DOWNLOAD, ADDRESS 1422.....	19
DISABLE KEYPAD INSTANT MODE, ADDRESS 1421.....	19
DISABLE OPENING REPORTS, ADDRESS 0785.....	22
DISABLE SYSTEM TROUBLE AUDIBLE TIMEOUT, ADDRESS 2051.....	19
DISABLE WAIT FOR HANDSHAKE ON TRANSMIT, ADDRESS 0788.....	22
DISABLE WAIT FOR SILENCE (PAGER FORMAT), ADDRESS 0788.....	22
DISABLE ZONE FAULT SCROLLING, ADDRESS 1420.....	19
DISABLED	
AREA OPTION.....	9
DON'T CLEAR PGM2 OUTPUT WITH DISARM, ADDRESS 1424.....	19
DOWNLOAD/CALLBACK OPTIONS (ADDRESS 2059 & 0526-0545).....	16
DOWNLOADING FROM A COMPUTER.....	4
EASY MENU DRIVEN PROGRAM MODE.....	5
EASY MENU PROGRAMMING WORKSHEET.....	42, 43, 44, 45
EASY MENU-DRIVEN PROGRAM.....	4
ENABLE "K SERIES" STYLE KEYPADS, ADDRESS 2051.....	19
ENABLE ALARM OUTPUT ON TELCO FAIL ONLY WHEN ARMED, ADDRESS 1423.....	19
ENABLE AUTOARM IF NOT CLOSED AT END OF WINDOW, ADDRESS 1420.....	19
ENABLE BURG OUTPUT CHIRP ON KEYFOB.....	8
ENABLE CANCEL REPORT TO TELCO 3, ADDRESS 2051.....	19
ENABLE CP-01 EGRESS TONES ONLY, ADDRESS 2053.....	19
ENABLE CP-01 LIMITS, ADDRESS 2053.....	19
ENABLE GEM-PRINT MODULE, ADDRESS 2051.....	19
ENABLE GLOBAL AMBUSH CODE, ADDRESS 1422.....	19
ENABLE KEYPAD 1 ONLY PROGRAMMING, ADDRESS 2053.....	19
ENABLE KEYPAD OPTIONS, ADDRESS 1440-1446.....	27
ENABLE KEYPAD SET TIME/DATE MESSAGE, ADDRESS 2051.....	19
ENABLE KEYPAD TIME/DATE DISPLAY, ADDRESS 1420.....	19
ENABLE KEYPAD TYPE & ACTIVATION, ADDRESS 1425-1431.....	27
ENABLE LINE-FAULT TEST, ADDRESS 1423.....	19
ENABLE LOCAL ALARM ON FIRST ZONE AND TRIP, ADDRESS 1421.....	19
ENABLE NO EOLR ZONES.....	7
ENABLE RESIDENTIAL FIRE, ADDRESS 1422.....	19
ENABLE SIA CP-01 FEATURES.....	8
ENABLE TCP/IP AES RPT, ADDRESS 0461.....	20
ENABLE TCP/IP AES RPT, ADDRESS 0483.....	20
ENABLE TCP/IP AES RPT, ADDRESS 0505.....	20
ENABLE TCP/IP COMMUNICATIONS, ADDRESS 2054.....	19
ENABLE TELCO LINE FAULT TEST.....	7
ENABLE TEMPERATURE DISPLAY OPTION, ADDRESS 1668.....	28
ENABLE USERS TO REPORT OPENING AND CLOSINGS.....	24
ENABLE ZONE DOUBLING (ZONES 9-16), ADDRESS 1423.....	19
ENABLE ZONE NUMBER ON PULSE ALARM, ADDRESS 0461.....	20
ENABLE ZONE NUMBER ON PULSE ALARM, ADDRESS 0483.....	20
ENABLE ZONE NUMBER ON PULSE ALARM, ADDRESS 0505.....	20
ENTER DATE.....	10, 39
ENTER TIME.....	10, 39
ENTER USER CODES.....	8
ENTER ZONE DESCRIPTIONS.....	10
ENTRY DELAY 1, ADDRESS 0001.....	15
ENTRY DELAY 2, ADDRESS 0002.....	15
ENTRY/EXIT 1 (ZONE OPTION), ADDRESS 0914, 0978.....	29
ENTRY/EXIT 1 (ZONE OPTION), ADDRESS 1042, 1106.....	30
ENTRY/EXIT 1 (ZONE OPTION), ADDRESS 1170, 1234.....	31



ALPHABETICAL INDEX (CONT'D)

ENTRY/EXIT 1 (ZONE OPTION), ADDRESS 1298, 1362.....	32	KEYPAD CONFIGURATION MODE.....	40
ENTRY/EXIT 2 (ZONE OPTION), ADDRESS 0915, 0979.....	29	KEYPAD EASY PROGRAM MENU.....	6
ENTRY/EXIT 2 (ZONE OPTION), ADDRESS 1043, 1107.....	30	KEYPAD ENTRY SOUNDER.....	40
ENTRY/EXIT 2 (ZONE OPTION), ADDRESS 1171, 1235.....	31	KEYPAD INSTALLATION.....	40
ENTRY/EXIT 2 (ZONE OPTION), ADDRESS 1299, 1363.....	32	KEYPAD OPTIONS (ADDRESS 1425-1431, 1440-1446).....	27
ERASE DEALER PROGRAM, ADDRESS 2285.....	37	KEYPAD SOUNDER ON ALARM (ZONE OPTION), ADDRESS 0941, 1005.....	29
ERASE ENTIRE PROGRAM, ADDRESS 2286.....	37	KEYPAD SOUNDER ON ALARM (ZONE OPTION), ADDRESS 1069, 1133.....	30
ERASING DEALER PROGRAM		KEYPAD SOUNDER ON ALARM (ZONE OPTION), ADDRESS 1197, 1261.....	31
EASY MENU.....	10	KEYPAD SOUNDER ON ALARM (ZONE OPTION), ADDRESS 1325, 1389.....	32
ERASING ENTIRE PROGRAM		KEYPAD SOUNDER ON ALARM ZONES.....	7
EASY MENU.....	10	KEYPAD TACTILE BEEP.....	40
EXIT DEALER PROGRAM MODE.....	10	KEYSWITCH ARMING (ZONE OPTION), ADDRESS 0905, 0969.....	29
EXIT DELAY, ADDRESS 0000.....	15	KEYSWITCH ARMING (ZONE OPTION), ADDRESS 1033, 1097.....	30
EXIT TIME RESTART, ADDRESS 2053.....	19	KEYSWITCH ARMING (ZONE OPTION), ADDRESS 1161, 1225.....	31
EXIT/ENTRY FOLLOWER (ZONE OPTION), ADDRESS 0916, 0980.....	29	KEYSWITCH ARMING (ZONE OPTION), ADDRESS 1289, 1353.....	32
EXIT/ENTRY FOLLOWER (ZONE OPTION), ADDRESS 1044, 1108.....	30	LEADING DIGITS FOR PAGER FORMAT (1ST DIGIT), ADDRESS 0546.....	16
EXIT/ENTRY FOLLOWER (ZONE OPTION), ADDRESS 1172, 1236.....	31	LEADING DIGITS FOR PAGER FORMAT (2ND DIGIT), ADDRESS 0547.....	16
EXIT/ENTRY FOLLOWER (ZONE OPTION), ADDRESS 1300, 1364.....	32	LINE-FAULT TEST ONLY WHEN ARMED, ADDRESS 1423.....	19
EXIT/ENTRY ZONES IN AREA 1.....	6	LOCAL DOWNLOADING.....	4
EXIT/ENTRY2 ZONES IN AREA 1.....	7	LOCAL OR CENTRAL STATION REPORTING SYSTEM.....	6
EXTERNAL RELAY CONTROL (ADDRESS 1489-1648).....	33	LOW BATTERY, ADDRESS 0686.....	22
EZM ADDRESS.....	41	LUG E15 AREA 1 ARMED AWAY ONLY, ADDRESS 2052.....	19
EZM GROUP OPTIONS (ADDRESS 1455-1468).....	25	MAINTAINED KEYSWITCH ARMING, ADDRESS 1421.....	19
EZM TAMPER, ADDRESS 0688.....	22	MEMORY FAIL, ADDRESS 0685.....	22
FAIL TO CLOSE, ADDRESS 0704.....	22	MODEM CODES.....	23
FAIL TO OPEN, ADDRESS 0703.....	22	NEVER ARM (ZONE OPTION), ADDRESS 0908, 0972.....	29
FIRE (MODEM CODE).....	23	NEVER ARM (ZONE OPTION), ADDRESS 1036, 1100.....	30
FIRE (ZONE OPTION), ADDRESS 0943, 1007.....	29	NEVER ARM (ZONE OPTION), ADDRESS 1164, 1228.....	31
FIRE (ZONE OPTION), ADDRESS 1071, 1135.....	30	NEVER ARM (ZONE OPTION), ADDRESS 1292, 1356.....	32
FIRE (ZONE OPTION), ADDRESS 1199, 1263.....	31	NEW PANELS.....	5
FIRE (ZONE OPTION), ADDRESS 1327, 1391.....	32	NO EOL RESISTOR (ZONE OPTION), ADDRESS 0933, 0997.....	29
FIRE ALARM VERIFICATION (ZONE OPTION), ADDRESS 0944, 1008.....	29	NO EOL RESISTOR (ZONE OPTION), ADDRESS 1061, 1125.....	30
FIRE ALARM VERIFICATION (ZONE OPTION), ADDRESS 1072, 1136.....	30	NO EOL RESISTOR (ZONE OPTION), ADDRESS 1189, 1253.....	31
FIRE ALARM VERIFICATION (ZONE OPTION), ADDRESS 1200, 1264.....	31	NO EOL RESISTOR (ZONE OPTION), ADDRESS 1317, 1381.....	32
FIRE ALARM VERIFICATION (ZONE OPTION), ADDRESS 1328, 1392.....	32	NO. RINGS BEFORE PICKUP, ADDRESS 2059.....	16
FIRE ZONES IN AREA 1.....	6	NUMBER OF KEYPADS IN AREA 1.....	8
FIRE, ADDRESS 0700.....	22	NUMBER OF RINGS BEFORE PICKUP, ADDRESS 2059.....	16
FIRMWARE VERSION.....	2	OPENING AFTER ALARM, ADDRESS 0679.....	22
FUNCTION MODE.....	4	OPENING REPORT.....	24
GAS ALARM (MODEM CODE).....	23	OPENING REPORT ONLY AFTER ALARM REPORT, ADDRESS 1420.....	19
GEM-P1664 WIRING DIAGRAM.....	56	OPENING, ADDRESS 0677.....	22
GEMINI KEYPAD EASY PROGRAM MENU.....	6	OUT OF SYSTEM.....	40
GLOBAL AMBUSH CODE, ADDRESS 2045.....	17	PAGER (CS RECEIVER 1 FORMAT).....	20
HEAT ALARM (MODEM CODE).....	23	PAGER FORMAT OPTIONS (ADDRESS 0546 & 0547).....	16
HEXADECIMAL FORMAT		PANEL AC FAIL, ADDRESS 0687.....	22
EXAMPLE.....	13	PANEL ZONE DOUBLING.....	6
HEXADECIMAL FORMAT EXAMPLE.....	13	PANIC (MODEM CODE).....	23
HOLD UP (MODEM CODE).....	23	PANIC, ADDRESS 0699.....	22
INCL. SEL./GRP. BYPASS IN COND. CLOSE /STATUS, ADDRESS 1420.....	19	PGM ON RF TRANSMITTER TAMPER, ADDRESS 2052.....	19
INHIBIT SYSTEM TROUBLE AUDIBLE AT KEYPAD, ADDRESS 1423.....	19	PGM1 OUTPUT (ZONE OPTION), ADDRESS 0912, 0976.....	29
INTERIOR (STAY) BYPASS (ZONE OPTION), ADDRESS 0940, 1004.....	29	PGM1 OUTPUT (ZONE OPTION), ADDRESS 1040, 1104.....	30
INTERIOR (STAY) BYPASS (ZONE OPTION), ADDRESS 1068, 1132.....	30	PGM1 OUTPUT (ZONE OPTION), ADDRESS 1168, 1232.....	31
INTERIOR (STAY) BYPASS (ZONE OPTION), ADDRESS 1196, 1260.....	31	PGM1 OUTPUT (ZONE OPTION), ADDRESS 1296, 1360.....	32
INTERIOR (STAY) BYPASS (ZONE OPTION), ADDRESS 1324, 1388.....	32	PGM1 OUTPUT TIMEOUT, ADDRESS 1416.....	16
INTERIOR NORMALLY BYPASSED, ADDRESS 1422.....	19	PGM1 OUTPUT TURNS OFF UPON DISARM, ADDRESS 1481.....	26
INTERIOR ZONES IN AREA 1.....	6	PGM1 OUTPUT TURNS OFF UPON DISARM, ADDRESS 1482.....	26
KEY FOB TRANSMITTERS AS ARM/DISARM & CONTROL DEVICES.....	9	PGM1 OUTPUT TURNS OFF UPON DISARM, ADDRESS 1483.....	26
KEY FOB TRANSMITTERS AS ZONE INPUT DEVICES.....	10	PGM1 OUTPUT TURNS OFF UPON DISARM, ADDRESS 1484.....	26
KEYFOB LOW BATTERY, ADDRESS 0705.....	22	PGM1 OUTPUT, ADDRESS 0838.....	17
KEYPAD		PGM1 OUTPUT, ADDRESS 0858.....	17
CONFIGURING.....	40	PGM1 OUTPUT, ADDRESS 0866.....	17
KEYPAD ADDRESS.....	40	PGM1 OUTPUT, ADDRESS 0874.....	18

ALPHABETICAL INDEX (CONT'D)

PGM1 OUTPUT, ADDRESS 0882	18	REPORT EVENT TELCO 1, ADDRESS 0869	17
PGM2 OUTPUT (ZONE OPTION), ADDRESS 0913, 0977.....	29	REPORT EVENT TELCO 1, ADDRESS 0877	18
PGM2 OUTPUT (ZONE OPTION), ADDRESS 1041, 1105.....	30	REPORT EVENT TELCO 1, ADDRESS 0885	18
PGM2 OUTPUT (ZONE OPTION), ADDRESS 1169, 1233.....	31	REPORT EVENT TELCO 3, ADDRESS 0842	17
PGM2 OUTPUT (ZONE OPTION), ADDRESS 1297, 1361.....	32	REPORT EVENT TELCO 3, ADDRESS 0863	17
PGM2 OUTPUT ACCESS CNTRL TIMEOUT, ADDRESS 1413.....	15	REPORT EVENT TELCO 3, ADDRESS 0871	17
PGM2 OUTPUT TIMEOUT, ADDRESS 1412	16	REPORT EVENT TELCO 3, ADDRESS 0879	18
PGM2 OUTPUT TURNS OFF UPON DISARM, ADDRESS 1485	26	REPORT EVENT TELCO 3, ADDRESS 0887	18
PGM2 OUTPUT TURNS OFF UPON DISARM, ADDRESS 1486	26	REPORT OPENING AND CLOSINGS	24
PGM2 OUTPUT TURNS OFF UPON DISARM, ADDRESS 1487	26	REPORT RESTORE TELCO 1, ADDRESS 0841.....	17
PGM2 OUTPUT TURNS OFF UPON DISARM, ADDRESS 1488	26	REPORT RESTORE TELCO 3, ADDRESS 0843.....	17
PGM2 OUTPUT, ADDRESS 0839	17	REPORT TEMPERATURE ALARM (ZONE 6), ADDRESS 1668	28
PGM2 OUTPUT, ADDRESS 0860	17	RESET DAY ZONE WITH ARM/DISARM ONLY, ADDRESS 1422	19
PGM2 OUTPUT, ADDRESS 0868	17	RESOUND ON WIRELESS SMOKE LOW BATTERY, ADDRESS 1424	19
PGM2 OUTPUT, ADDRESS 0876	18	RF REC. TROUBLE, ADDRESS 0684.....	22
PGM2 OUTPUT, ADDRESS 0884	18	RF RECEIVER & SUPERVISORY TIMER OPTIONS (ADDRESS 2029-2044 & 2056).....	36
POWER-UP DELAY (ZONE OPTION), ADDRESS 0921, 0985.....	29	RF TRANSMITTER POINTS	9
POWER-UP DELAY (ZONE OPTION), ADDRESS 1049, 1113.....	30	RPT EXIT ERR/RECENT CLOSE, ADDRESS 2053	19
POWER-UP DELAY (ZONE OPTION), ADDRESS 1177, 1241.....	31	SELECT ALARM OUTPUT FOR KEYFOB CHIRP, ADDRESS 1423.....	19
POWER-UP DELAY (ZONE OPTION), ADDRESS 1305, 1369.....	32	SELECT DEGREES CELSIUS, ADDRESS 1668	28
PRE-ALARM WARNING (ZONE OPTION), ADDRESS 0907, 0971	29	SELECTIVE BYPASS (ZONE OPTION), ADDRESS 0904, 0968.....	29
PRE-ALARM WARNING (ZONE OPTION), ADDRESS 1035, 1099	30	SELECTIVE BYPASS (ZONE OPTION), ADDRESS 1032, 1096.....	30
PRE-ALARM WARNING (ZONE OPTION), ADDRESS 1163, 1227	31	SELECTIVE BYPASS (ZONE OPTION), ADDRESS 1160, 1224.....	31
PRE-ALARM WARNING (ZONE OPTION), ADDRESS 1291, 1355	32	SELECTIVE BYPASS (ZONE OPTION), ADDRESS 1288, 1352.....	32
PRIORITY (ZONE OPTION), ADDRESS 0901, 0965.....	29	SENSOR WATCH (ZONE OPTION), ADDRESS 0950, 1014.....	29
PRIORITY (ZONE OPTION), ADDRESS 1029, 1093	30	SENSOR WATCH (ZONE OPTION), ADDRESS 1078, 1142.....	30
PRIORITY (ZONE OPTION), ADDRESS 1157, 1221	31	SENSOR WATCH (ZONE OPTION), ADDRESS 1206, 1270.....	31
PRIORITY (ZONE OPTION), ADDRESS 1285, 1349.....	32	SENSOR WATCH (ZONE OPTION), ADDRESS 1334, 1398.....	32
PRIORITY ARMING AREA 1, ADDRESS 1469	25	SENSOR WATCH TIME, ADDRESS 2050.....	15
PRIORITY ARMING AREA 2, ADDRESS 1470	25	SENSOR WATCH ZONES	7
PRIORITY ARMING AREA 3, ADDRESS 1471	25	SIA (CS RECEIVER 1 FORMAT)	20
PRIORITY ARMING AREA 4, ADDRESS 1472	25	SILENT KNIGHT FAST (CS RECEIVER 1 FORMAT).....	20
PRIORITY WITH BYPASS (ZONE OPTION), ADDRESS 0902, 0966	29	SINGLE DIGIT ONLY, ADDRESS 0461	20
PRIORITY WITH BYPASS (ZONE OPTION), ADDRESS 1030, 1094	30	SINGLE DIGIT ONLY, ADDRESS 0483	20
PRIORITY WITH BYPASS (ZONE OPTION), ADDRESS 1158, 1222	31	SINGLE DIGIT ONLY, ADDRESS 0505	20
PRIORITY WITH BYPASS (ZONE OPTION), ADDRESS 1286, 1350	32	SOUND ALARM ON EXIT ERROR, ADDRESS 2053.....	19
PROGRAM CONTROL MESSAGE	41	STATUS REPORT, ADDRESS 1420	19
PROGRAMMING CONVENTIONS.....	14	SUM CHECK, ADDRESS 0461	20
PROGRAMMING STEPS		SUM CHECK, ADDRESS 0483	20
GENERAL	14	SUM CHECK, ADDRESS 0505	20
PULSE ALARM OUTPUT TIMEOUT, ADDRESS 1415.....	16	SUPPRESS BYPASS REMINDER WHEN ARMED, ADDRESS 1421	19
PULSE EVENT CODE.....	23	SWINGER SHUTDOWN (ZONE OPTION), ADDRESS 0918, 0982	29
PULSED ALARM OUTPUT (ZONE OPTION), ADDRESS 0911, 0975	29	SWINGER SHUTDOWN (ZONE OPTION), ADDRESS 1046, 1110	30
PULSED ALARM OUTPUT (ZONE OPTION), ADDRESS 1039, 1103.....	30	SWINGER SHUTDOWN (ZONE OPTION), ADDRESS 1174, 1238	31
PULSED ALARM OUTPUT (ZONE OPTION), ADDRESS 1167, 1231	31	SWINGER SHUTDOWN (ZONE OPTION), ADDRESS 1302, 1366	32
PULSED ALARM OUTPUT (ZONE OPTION), ADDRESS 1295, 1359	32	SYSTEM DELAYS & TIMEOUTS (ADDRESS 0000-0002, 1413, 1417, 2050 & 2055).....	15
PULSED ALARM OUTPUT, ADDRESS 0837	17	SYSTEM DELAYS & TIMEOUTS (ADDRESS 1418-1419).....	15
PULSED ALARM OUTPUT, ADDRESS 0856	17	SYSTEM OPTIONS (ADDRESS 0836-0871 & 2045).....	17
PULSED ALARM OUTPUT, ADDRESS 0864	17	SYSTEM OPTIONS (ADDRESS 0872-0887)	18
PULSED ALARM OUTPUT, ADDRESS 0872	18	SYSTEM OPTIONS (ADDRESS 1420-1424, 2051-2054)	19
PULSED ALARM OUTPUT, ADDRESS 0880.....	18	SYSTEM OUTPUT TIMEOUTS (ADDRESS 1412 & 1414-1416).....	16
PULSED BURG OUTPUT TURNS OFF UPON DISARM, ADDRESS 1477	26	SYSTEM PROGRAMMING OPTIONS	4
PULSED BURG OUTPUT TURNS OFF UPON DISARM, ADDRESS 1478	26	SYSTEM RESPONSE ACTIVATED BY AREA 1 EVENT/TROUBLE	17
PULSED BURG OUTPUT TURNS OFF UPON DISARM, ADDRESS 1479	26	SYSTEM RESPONSE ACTIVATED BY AREA 2 EVENT/TROUBLE	17
PULSED BURG OUTPUT TURNS OFF UPON DISARM, ADDRESS 1480	26	SYSTEM RESPONSE ACTIVATED BY AREA 3 EVENT/TROUBLE	18
QUICK METHOD	9	SYSTEM RESPONSE ACTIVATED BY AREA 4 EVENT/TROUBLE	18
RADIONICS FAST (CS RECEIVER 1 FORMAT).....	20	SYSTEM RESPONSE ACTIVATED BY GLOBAL EVENT/TROUBLE	17
RADIONICS, DCI, FRANKLIN SLOW (CS RECEIVER 1 FORMAT).....	20	TAMPER, ADDRESS 0702.....	22
RELAY MODULE RM3008.....	34	TCP/IP PANEL/SITE INITIATED FUNCTIONS, ADDRESS 2054	19
REMOTE DOWNLOADING	4	TELCO FAIL, ADDRESS 0683	22
REPORT CANCEL WINDOW, ADDRESS 2055.....	15	TEMPERATURE DISPLAY AT KEYPAD (ADDRESS 1666-1668).....	28
REPORT EVENT TELCO 1, ADDRESS 0840.....	17		
REPORT EVENT TELCO 1, ADDRESS 0861.....	17		



ALPHABETICAL INDEX (CONT'D)

TEMPERATURE LOWER LIMIT, ADDRESS 1666.....	28
TEMPERATURE OPTIONS, ADDRESS 1668.....	28
TEMPERATURE UPPER LIMIT, ADDRESS 1667.....	28
TEST TIMER, ADDRESS 0682.....	22
TIME.....	10
TOTAL NUMBER OF ZONES IN AREA 1.....	6
TOUCH-TONE DIALING ONLY, ADDRESS 0788.....	22
TOUCH-TONE DIALING W/ROTARY BACKUP, ADDRESS 0788.....	22
TRANSMITTER WIRELESS POINTS	
ENROLLING.....	9
TROUBLE ON OPEN (ZONE OPTION), ADDRESS 0934, 0998.....	29
TROUBLE ON OPEN (ZONE OPTION), ADDRESS 1062, 1126.....	30
TROUBLE ON OPEN (ZONE OPTION), ADDRESS 1190, 1254.....	31
TROUBLE ON OPEN (ZONE OPTION), ADDRESS 1318, 1382.....	32
TROUBLE ON SHORT (ZONE OPTION), ADDRESS 0935, 0999.....	29
TROUBLE ON SHORT (ZONE OPTION), ADDRESS 1063, 1127.....	30
TROUBLE ON SHORT (ZONE OPTION), ADDRESS 1191, 1255.....	31
TROUBLE ON SHORT (ZONE OPTION), ADDRESS 1319, 1383.....	32
TROUBLE RESTORE 1 (ZONE OPTION), ADDRESS 0928, 0992.....	29
TROUBLE RESTORE 1 (ZONE OPTION), ADDRESS 1056, 1120.....	30
TROUBLE RESTORE 1 (ZONE OPTION), ADDRESS 1184, 1248.....	31
TROUBLE RESTORE 1 (ZONE OPTION), ADDRESS 1312, 1376.....	32
TROUBLE RESTORE 3 (ZONE OPTION), ADDRESS 0932, 0996.....	29
TROUBLE RESTORE 3 (ZONE OPTION), ADDRESS 1060, 1124.....	30
TROUBLE RESTORE 3 (ZONE OPTION), ADDRESS 1188, 1252.....	31
TROUBLE RESTORE 3 (ZONE OPTION), ADDRESS 1316, 1380.....	32
TROUBLE RESTORE, ADDRESS 0672.....	22
TROUBLE TELCO 1 (ZONE OPTION), ADDRESS 0927, 0991.....	29
TROUBLE TELCO 1 (ZONE OPTION), ADDRESS 1055, 1119.....	30
TROUBLE TELCO 1 (ZONE OPTION), ADDRESS 1183, 1247.....	31
TROUBLE TELCO 1 (ZONE OPTION), ADDRESS 1311, 1375.....	32
TROUBLE TELCO 3 (ZONE OPTION), ADDRESS 0931, 0995.....	29
TROUBLE TELCO 3 (ZONE OPTION), ADDRESS 1059, 1123.....	30
TROUBLE TELCO 3 (ZONE OPTION), ADDRESS 1187, 1251.....	31
TROUBLE TELCO 3 (ZONE OPTION), ADDRESS 1315, 1379.....	32
TROUBLE, ADDRESS 0671.....	22
UNIVERSAL HIGH SPEED (CS RECEIVER 1 FORMAT).....	20
USER CODES.....	38
USER PROGRAM	
AREA OPTION.....	9
USER PROGRAM MODE.....	4
USER PROGRAM MODE	
ACCESSING.....	38
PRELIMINARY INFORMATION.....	37
USERS TO REPORT OPENING AND CLOSINGS.....	24
VERI-PHONE AUDIO PRIORITY OVER ALARMS, ADDRESS 1424.....	19
VERI-PHONE ZONES TRIP PGM2 OUTPUT, ADDRESS 1424.....	19
WIRELESS TROUBLE ACTIVATES TELCO 1, ADDRESS 1423.....	19
WIRELESS TROUBLE ACTIVATES TELCO 3, ADDRESS 1423.....	19
WIRING DIAGRAM.....	56
XMITTER LOW BATTERY, ADDRESS 0673.....	22
XMITTER SUPERVISION, ADDRESS 0674.....	22
XMITTER TAMPER, ADDRESS 0675.....	22
ZONE 6 TEMPERATURE SENSOR.....	28
ZONE ANDING GROUP 1 (ZONE OPTION), ADDRESS 0946, 1010.....	29
ZONE ANDING GROUP 1 (ZONE OPTION), ADDRESS 1074, 1138.....	30
ZONE ANDING GROUP 1 (ZONE OPTION), ADDRESS 1202, 1266.....	31
ZONE ANDING GROUP 1 (ZONE OPTION), ADDRESS 1330, 1394.....	32
ZONE ANDING GROUP 2 (ZONE OPTION), ADDRESS 0947, 1011.....	29
ZONE ANDING GROUP 2 (ZONE OPTION), ADDRESS 1075, 1139.....	30
ZONE ANDING GROUP 2 (ZONE OPTION), ADDRESS 1203, 1267.....	31
ZONE ANDING GROUP 2 (ZONE OPTION), ADDRESS 1331, 1395.....	32
ZONE ANDING GROUP 3 (ZONE OPTION), ADDRESS 0948, 1012.....	29
ZONE ANDING GROUP 3 (ZONE OPTION), ADDRESS 1076, 1140.....	30
ZONE ANDING GROUP 3 (ZONE OPTION), ADDRESS 1204, 1268.....	31
ZONE ANDING GROUP 3 (ZONE OPTION), ADDRESS 1332, 1396.....	32
ZONE ANDING GROUP 4 (ZONE OPTION), ADDRESS 0949, 1013.....	29
ZONE ANDING GROUP 4 (ZONE OPTION), ADDRESS 1077, 1141.....	30
ZONE ANDING GROUP 4 (ZONE OPTION), ADDRESS 1205, 1269.....	31
ZONE ANDING GROUP 4 (ZONE OPTION), ADDRESS 1333, 1397.....	32
ZONE AREA 1 (ZONE OPTION), ADDRESS 0936, 1000.....	29
ZONE AREA 1 (ZONE OPTION), ADDRESS 1064, 1128.....	30
ZONE AREA 1 (ZONE OPTION), ADDRESS 1192, 1256.....	31
ZONE AREA 1 (ZONE OPTION), ADDRESS 1320, 1384.....	32
ZONE AREA 2 (ZONE OPTION), ADDRESS 0937, 1001.....	29
ZONE AREA 2 (ZONE OPTION), ADDRESS 1065, 1129.....	30
ZONE AREA 2 (ZONE OPTION), ADDRESS 1193, 1257.....	31
ZONE AREA 2 (ZONE OPTION), ADDRESS 1321, 1385.....	32
ZONE AREA 3 (ZONE OPTION), ADDRESS 0938, 1002.....	29
ZONE AREA 3 (ZONE OPTION), ADDRESS 1066, 1130.....	30
ZONE AREA 3 (ZONE OPTION), ADDRESS 1194, 1258.....	31
ZONE AREA 3 (ZONE OPTION), ADDRESS 1322, 1386.....	32
ZONE AREA 4 (ZONE OPTION), ADDRESS 0939, 1003.....	29
ZONE AREA 4 (ZONE OPTION), ADDRESS 1067, 1131.....	30
ZONE AREA 4 (ZONE OPTION), ADDRESS 1195, 1259.....	31
ZONE AREA 4 (ZONE OPTION), ADDRESS 1323, 1387.....	32
ZONE DESCRIPTIONS	
ENTERING.....	10
ZONE DESCRIPTIONS.....	39
ZONE DOUBLING.....	6
ZONE OPTIONS - ZONES 1 TO 16 (ADDRESS 0900-1019).....	29
ZONE OPTIONS - ZONES 17 TO 32 (ADDRESS 1029-1147).....	30
ZONE OPTIONS - ZONES 33 TO 48 (ADDRESS 1157-1275).....	31
ZONE OPTIONS - ZONES 49 TO 64 (ADDRESS 1285-1403).....	32
ZONE REPORT CODE OPTIONS.....	23
ZONE RESPONSE.....	41

ADDRESS NUMBER INDEX

ADDRESS 0000.....	EXIT DELAY.....	15
ADDRESS 0000-0002.....	SYSTEM DELAYS & TIMEOUTS.....	15
ADDRESS 0001.....	ENTRY DELAY 1.....	15
ADDRESS 0002.....	ENTRY DELAY 2.....	15
ADDRESS 0460.....	CS RECEIVER 1 FORMAT.....	20
ADDRESS 0461.....	1400HZ HANDSHAKE/KISSOFF.....	20
ADDRESS 0461.....	2300HZ HANDSHAKE/KISSOFF.....	20
ADDRESS 0461.....	3/1 WITH EXTENDED RESTORES.....	20
ADDRESS 0461.....	CS RECEIVER OPTIONS - TELCO 1.....	20
ADDRESS 0461.....	ENABLE ZONE NUMBER ON PULSE ALARM.....	20
ADDRESS 0461.....	SINGLE DIGIT ONLY.....	20
ADDRESS 0461.....	SUM CHECK.....	20
ADDRESS 0461.....	ENABLE TCP/IP AES RPT.....	20
ADDRESS 0462-0481.....	CS RECEIVER 1 TELEPHONE NUMBER.....	20
ADDRESS 0482.....	CS RECEIVER 2 FORMAT.....	20
ADDRESS 0483.....	1400HZ HANDSHAKE/KISSOFF.....	20
ADDRESS 0483.....	2300HZ HANDSHAKE/KISSOFF.....	20
ADDRESS 0483.....	3/1 WITH EXTENDED RESTORES.....	20
ADDRESS 0483.....	CS RECEIVER OPTIONS - TELCO 2.....	20
ADDRESS 0483.....	ENABLE ZONE NUMBER ON PULSE ALARM.....	20
ADDRESS 0483.....	SINGLE DIGIT ONLY.....	20
ADDRESS 0483.....	SUM CHECK.....	20
ADDRESS 0483.....	ENABLE TCP/IP AES RPT.....	20
ADDRESS 0484-0503.....	CS RECEIVER 2 TELEPHONE NUMBER.....	20
ADDRESS 0504.....	CS RECEIVER 3 FORMAT.....	20
ADDRESS 0505.....	1400HZ HANDSHAKE/KISSOFF.....	20
ADDRESS 0505.....	2300HZ HANDSHAKE/KISSOFF.....	20
ADDRESS 0505.....	3/1 WITH EXTENDED RESTORES.....	20
ADDRESS 0505.....	CS RECEIVER OPTIONS - TELCO 3.....	20
ADDRESS 0505.....	ENABLE ZONE NUMBER ON PULSE ALARM.....	20
ADDRESS 0505.....	SINGLE DIGIT ONLY.....	20
ADDRESS 0505.....	SUM CHECK.....	20
ADDRESS 0505.....	ENABLE TCP/IP AES RPT.....	20
ADDRESS 0506-0525.....	CS RECEIVER 3 TELEPHONE NUMBER.....	20
ADDRESS 0526-0545.....	DOWNLOAD/CALLBACK OPTIONS.....	16
ADDRESS 0546.....	LEADING DIGITS FOR PAGER FORMAT (1ST DIGIT).....	16
ADDRESS 0546.....	PAGER FORMAT OPTIONS.....	16
ADDRESS 0547.....	LEADING DIGITS FOR PAGER FORMAT (2ND DIGIT).....	16
ADDRESS 0547.....	PAGER FORMAT OPTIONS.....	16
ADDRESS 0560-0667.....	CS SUBSCRIBER ID OPTIONS.....	21
ADDRESS 0670.....	ALARM RESTORE.....	22
ADDRESS 0671.....	TROUBLE.....	22
ADDRESS 0672.....	TROUBLE RESTORE.....	22
ADDRESS 0673.....	XMITTER LOW BATTERY.....	22
ADDRESS 0674.....	XMITTER SUPERVISION.....	22
ADDRESS 0675.....	XMITTER TAMPER.....	22
ADDRESS 0677.....	OPENING.....	22
ADDRESS 0678.....	CLOSING.....	22
ADDRESS 0679.....	OPENING AFTER ALARM.....	22
ADDRESS 0680.....	CONDITIONAL CLOSE.....	22
ADDRESS 0681.....	CANCEL.....	22



ADDRESS NUMBER INDEX (CONT'D)

ADDRESS 0682.....	TEST TIMER.....	22
ADDRESS 0683.....	TELCO FAIL.....	22
ADDRESS 0683-0708.....	CS SYSTEM REPORTING CODES.....	22
ADDRESS 0684.....	RF REC. TROUBLE.....	22
ADDRESS 0685.....	MEMORY FAIL.....	22
ADDRESS 0686.....	LOW BATTERY.....	22
ADDRESS 0687.....	PANEL AC FAIL.....	22
ADDRESS 0688.....	EZM TAMPER.....	22
ADDRESS 0689.....	ALARM OUTPUT SUPERV.....	22
ADDRESS 0698.....	AMBUSH.....	22
ADDRESS 0699.....	PANIC.....	22
ADDRESS 0700.....	FIRE.....	22
ADDRESS 0701.....	AUXILIARY.....	22
ADDRESS 0702.....	TAMPER.....	22
ADDRESS 0703.....	FAIL TO OPEN.....	22
ADDRESS 0704.....	FAIL TO CLOSE.....	22
ADDRESS 0705.....	KEYFOB LOW BATTERY.....	22
ADDRESS 0720-0783.....	CS ZONE REPORTING OPTIONS.....	23
ADDRESS 0785.....	CS AREA & SYSTEM REPORTING OPTIONS.....	22
ADDRESS 0785.....	DISABLE OPENING REPORTS.....	22
ADDRESS 0786.....	CS AREA & SYSTEM REPORTING OPTIONS.....	22
ADDRESS 0786.....	DISABLE CLOSING REPORTS.....	22
ADDRESS 0788.....	BACKUP REPORT ON TELCO 1 & 2.....	22
ADDRESS 0788.....	CANCEL NEXT TEST TIMER ON ANY REPORT.....	22
ADDRESS 0788.....	CS AREA & SYSTEM REPORTING OPTIONS.....	22
ADDRESS 0788.....	CS SYSTEM REPORT OPTIONS.....	22
ADDRESS 0788.....	DISABLE AUTO DIAL TONE DETECT.....	22
ADDRESS 0788.....	DISABLE WAIT FOR HANDSHAKE ON TRANSMIT.....	22
ADDRESS 0788.....	DISABLE WAIT FOR SILENCE (PAGER FORMAT).....	22
ADDRESS 0788.....	TOUCH-TONE DIALING ONLY.....	22
ADDRESS 0788.....	TOUCH-TONE DIALING W/ROTARY BACKUP.....	22
ADDRESS 0800-0835.....	CS USER REPORTING OPTIONS.....	24
ADDRESS 0836.....	ALARM OUTPUT.....	17
ADDRESS 0836-0871.....	SYSTEM OPTIONS.....	17
ADDRESS 0837.....	PULSED ALARM OUTPUT.....	17
ADDRESS 0838.....	PGM1 OUTPUT.....	17
ADDRESS 0839.....	PGM2 OUTPUT.....	17
ADDRESS 0840.....	REPORT EVENT TELCO 1.....	17
ADDRESS 0841.....	REPORT RESTORE TELCO 1.....	17
ADDRESS 0842.....	REPORT EVENT TELCO 3.....	17
ADDRESS 0843.....	REPORT RESTORE TELCO 3.....	17
ADDRESS 0856.....	PULSED ALARM OUTPUT.....	17
ADDRESS 0857.....	ALARM OUTPUT.....	17
ADDRESS 0858.....	PGM1 OUTPUT.....	17
ADDRESS 0860.....	PGM2 OUTPUT.....	17
ADDRESS 0861.....	REPORT EVENT TELCO 1.....	17
ADDRESS 0863.....	REPORT EVENT TELCO 3.....	17
ADDRESS 0864.....	PULSED ALARM OUTPUT.....	17
ADDRESS 0865.....	ALARM OUTPUT.....	17
ADDRESS 0866.....	PGM1 OUTPUT.....	17
ADDRESS 0868.....	PGM2 OUTPUT.....	17

ADDRESS NUMBER INDEX (CONT'D)

ADDRESS 0869	REPORT EVENT TELCO 1	17
ADDRESS 0871	REPORT EVENT TELCO 3	17
ADDRESS 0872	PULSED ALARM OUTPUT	18
ADDRESS 0872-0887	SYSTEM OPTIONS	18
ADDRESS 0873	ALARM OUTPUT	18
ADDRESS 0874	PGM1 OUTPUT	18
ADDRESS 0876	PGM2 OUTPUT	18
ADDRESS 0877	REPORT EVENT TELCO 1	18
ADDRESS 0879	REPORT EVENT TELCO 3	18
ADDRESS 0880	PULSED ALARM OUTPUT	18
ADDRESS 0881	ALARM OUTPUT	18
ADDRESS 0882	PGM1 OUTPUT	18
ADDRESS 0884	PGM2 OUTPUT	18
ADDRESS 0885	REPORT EVENT TELCO 1	18
ADDRESS 0887	REPORT EVENT TELCO 3	18
ADDRESS 0900-1019	ZONE OPTIONS - ZONES 1 TO 16	29
ADDRESS 1029-1147	ZONE OPTIONS - ZONES 17 TO 32	30
ADDRESS 1157-1275	ZONE OPTIONS - ZONES 33 TO 48	31
ADDRESS 1285-1403	ZONE OPTIONS - ZONES 49 TO 64	32
ADDRESS 1412	PGM2 OUTPUT TIMEOUT	16
ADDRESS 1412	SYSTEM OUTPUT TIMEOUTS	16
ADDRESS 1413	PGM2 OUTPUT ACCESS CNTRL TIMEOUT	15
ADDRESS 1413	SYSTEM DELAYS & TIMEOUTS	15
ADDRESS 1414	ALARM OUTPUT TIMEOUT	16
ADDRESS 1414-1416	SYSTEM OUTPUT TIMEOUTS	16
ADDRESS 1415	PULSE ALARM OUTPUT TIMEOUT	16
ADDRESS 1416	PGM1 OUTPUT TIMEOUT	16
ADDRESS 1417	ABORT DELAY	15
ADDRESS 1417	SYSTEM DELAYS & TIMEOUTS	15
ADDRESS 1418	CHIME TIME	15
ADDRESS 1418-1419	SYSTEM DELAYS & TIMEOUTS	15
ADDRESS 1419	AC FAIL REPORT DELAY	15
ADDRESS 1420	CLOSING REPORT ONLY ON CONDITIONAL CLOSE	19
ADDRESS 1420	DISABLE ZONE FAULT SCROLLING	19
ADDRESS 1420	ENABLE AUTOARM IF NOT CLOSED AT END OF WINDOW	19
ADDRESS 1420	ENABLE KEYPAD TIME/DATE DISPLAY	19
ADDRESS 1420	INCL. SEL./GRP. BYPASS IN COND. CLOSE /STATUS	19
ADDRESS 1420	OPENING REPORT ONLY AFTER ALARM REPORT	19
ADDRESS 1420	STATUS REPORT	19
ADDRESS 1420-1424	SYSTEM OPTIONS	19
ADDRESS 1421	ACCESS CONTROL ON PGM2 OUTPUT	19
ADDRESS 1421	AUTO BELL TEST ON ARMING	19
ADDRESS 1421	AUTO RESET AFTER BURGLARY OUTPUT TIMEOUT	19
ADDRESS 1421	DISABLE KEYPAD INSTANT MODE	19
ADDRESS 1421	ENABLE LOCAL ALARM ON FIRST ZONE AND TRIP	19
ADDRESS 1421	MAINTAINED KEYSWITCH ARMING	19
ADDRESS 1421	SUPPRESS BYPASS REMINDER WHEN ARMED	19
ADDRESS 1422	CHANGE PULSE OUTPUT TO TEMPORAL OUTPUT	19
ADDRESS 1422	CHIRP OUTPUT ON KEYFOB ARM/DISARM	19
ADDRESS 1422	DISABLE CALLBACK DOWNLOAD	19
ADDRESS 1422	DISABLE KEYPAD FUNCTION MODE DOWNLOAD	19



ADDRESS NUMBER INDEX (CONT'D)

ADDRESS 1422.....	ENABLE GLOBAL AMBUSH CODE.....	19
ADDRESS 1422.....	ENABLE RESIDENTIAL FIRE.....	19
ADDRESS 1422.....	INTERIOR NORMALLY BYPASSED.....	19
ADDRESS 1422.....	RESET DAY ZONE WITH ARM/DISARM ONLY.....	19
ADDRESS 1423.....	ENABLE ALARM OUTPUT ON TELCO FAIL ONLY WHEN ARMED.....	19
ADDRESS 1423.....	ENABLE LINE-FAULT TEST.....	19
ADDRESS 1423.....	ENABLE ZONE DOUBLING (ZONES 9-16).....	19
ADDRESS 1423.....	INHIBIT SYSTEM TROUBLE AUDIBLE AT KEYPAD.....	19
ADDRESS 1423.....	LINE-FAULT TEST ONLY WHEN ARMED.....	19
ADDRESS 1423.....	SELECT ALARM OUTPUT FOR KEYFOB CHIRP.....	19
ADDRESS 1423.....	WIRELESS TROUBLE ACTIVATES TELCO 1.....	19
ADDRESS 1423.....	WIRELESS TROUBLE ACTIVATES TELCO 3.....	19
ADDRESS 1424.....	AUTOMATIC INTERIOR BYPASS/EASY EXIT.....	19
ADDRESS 1424.....	DISABLE 2ND CALL ANS. MACHINE OVERRIDE.....	19
ADDRESS 1424.....	DISABLE CODE REQUIRED FOR EZ BYPASS.....	19
ADDRESS 1424.....	DON'T CLEAR PGM2 OUTPUT WITH DISARM.....	19
ADDRESS 1424.....	RESOUND ON WIRELESS SMOKE LOW BATTERY.....	19
ADDRESS 1424.....	VERI-PHONE AUDIO PRIORITY OVER ALARMS.....	19
ADDRESS 1424.....	VERI-PHONE ZONES TRIP PGM2 OUTPUT.....	19
ADDRESS 1425-1431.....	ENABLE KEYPAD TYPE & ACTIVATION.....	27
ADDRESS 1425-1431.....	KEYPAD OPTIONS.....	27
ADDRESS 1440-1446.....	ENABLE KEYPAD OPTIONS.....	27
ADDRESS 1440-1446.....	KEYPAD OPTIONS.....	27
ADDRESS 1455-1468.....	EZM GROUP OPTIONS.....	25
ADDRESS 1469.....	PRIORITY ARMING AREA 1.....	25
ADDRESS 1469-1472.....	AREA ARMING OPTIONS.....	25
ADDRESS 1470.....	PRIORITY ARMING AREA 2.....	25
ADDRESS 1471.....	PRIORITY ARMING AREA 3.....	25
ADDRESS 1472.....	PRIORITY ARMING AREA 4.....	25
ADDRESS 1473.....	BURGLARY OUTPUT TURNS OFF UPON DISARM.....	26
ADDRESS 1473-1488.....	AREA BELL CONTROL OPTIONS.....	26
ADDRESS 1474.....	BURGLARY OUTPUT TURNS OFF UPON DISARM.....	26
ADDRESS 1475.....	BURGLARY OUTPUT TURNS OFF UPON DISARM.....	26
ADDRESS 1476.....	BURGLARY OUTPUT TURNS OFF UPON DISARM.....	26
ADDRESS 1477.....	PULSED BURG OUTPUT TURNS OFF UPON DISARM.....	26
ADDRESS 1478.....	PULSED BURG OUTPUT TURNS OFF UPON DISARM.....	26
ADDRESS 1479.....	PULSED BURG OUTPUT TURNS OFF UPON DISARM.....	26
ADDRESS 1480.....	PULSED BURG OUTPUT TURNS OFF UPON DISARM.....	26
ADDRESS 1481.....	PGM1 OUTPUT TURNS OFF UPON DISARM.....	26
ADDRESS 1482.....	PGM1 OUTPUT TURNS OFF UPON DISARM.....	26
ADDRESS 1483.....	PGM1 OUTPUT TURNS OFF UPON DISARM.....	26
ADDRESS 1484.....	PGM1 OUTPUT TURNS OFF UPON DISARM.....	26
ADDRESS 1485.....	PGM2 OUTPUT TURNS OFF UPON DISARM.....	26
ADDRESS 1486.....	PGM2 OUTPUT TURNS OFF UPON DISARM.....	26
ADDRESS 1487.....	PGM2 OUTPUT TURNS OFF UPON DISARM.....	26
ADDRESS 1488.....	PGM2 OUTPUT TURNS OFF UPON DISARM.....	26
ADDRESS 1489-1648.....	EXTERNAL RELAY CONTROL.....	33
ADDRESS 1666.....	TEMPERATURE LOWER LIMIT.....	28
ADDRESS 1666-1668.....	TEMPERATURE DISPLAY AT KEYPAD.....	28
ADDRESS 1667.....	TEMPERATURE UPPER LIMIT.....	28
ADDRESS 1668.....	ENABLE TEMPERATURE DISPLAY OPTION.....	28



ADDRESS NUMBER INDEX (CONT'D)

ADDRESS 1668.....	REPORT TEMPERATURE ALARM (ZONE 6)	28
ADDRESS 1668.....	SELECT DEGREES CELSIUS	28
ADDRESS 1668.....	TEMPERATURE OPTIONS.....	28
ADDRESS 2029-2044.....	RF RECEIVER & SUPERVISORY TIMER OPTIONS	36
ADDRESS 2045.....	GLOBAL AMBUSH CODE	17
ADDRESS 2045.....	SYSTEM OPTIONS	17
ADDRESS 2050.....	SENSOR WATCH TIME	15
ADDRESS 2050.....	SYSTEM DELAYS & TIMEOUTS	15
ADDRESS 2051.....	DISABLE [ON/OFF] AS EASY EXIT	19
ADDRESS 2051.....	DISABLE SYSTEM TROUBLE AUDIBLE TIMEOUT.....	19
ADDRESS 2051.....	ENABLE "K SERIES" STYLE KEYPADS.....	19
ADDRESS 2051.....	ENABLE CANCEL REPORT TO TELCO 3.....	19
ADDRESS 2051.....	ENABLE GEM-PRINT MODULE.....	19
ADDRESS 2051.....	ENABLE KEYPAD SET TIME/DATE MESSAGE.....	19
ADDRESS 2051-2054.....	SYSTEM OPTIONS	19
ADDRESS 2052.....	LUG E15 AREA 1 ARMED AWAY ONLY	19
ADDRESS 2052.....	PGM ON RF TRANSMITTER TAMPER	19
ADDRESS 2053.....	DIGITAL DIALER RPT ENTER /EXIT TEST MODE	19
ADDRESS 2053.....	DISABLE CALL WAITING ON 1ST ATTEMPT	19
ADDRESS 2053.....	ENABLE CP-01 EGRESS TONES ONLY.....	19
ADDRESS 2053.....	ENABLE CP-01 LIMITS	19
ADDRESS 2053.....	ENABLE KEYPAD 1 ONLY PROGRAMMING.....	19
ADDRESS 2053.....	EXIT TIME RESTART	19
ADDRESS 2053.....	RPT EXIT ERR/RECENT CLOSE.....	19
ADDRESS 2053.....	SOUND ALARM ON EXIT ERROR.....	19
ADDRESS 2054.....	ENABLE TCP/IP COMMUNICATIONS.....	19
ADDRESS 2054.....	TCP/IP PANEL/SITE INITIATED FUNCTIONS.....	19
ADDRESS 2055.....	REPORT CANCEL WINDOW	15
ADDRESS 2055.....	SYSTEM DELAYS & TIMEOUTS	15
ADDRESS 2056.....	RF RECEIVER & SUPERVISORY TIMER OPTIONS	36
ADDRESS 2059.....	DOWNLOAD/CALLBACK OPTIONS	16
ADDRESS 2059.....	NO. RINGS BEFORE PICKUP	16
ADDRESS 2059.....	NUMBER OF RINGS BEFORE PICKUP	16
ADDRESS 2285.....	CLEAR DEALER PROGRAM	37
ADDRESS 2285.....	ERASE DEALER PROGRAM	37
ADDRESS 2286.....	COLD START.....	37
ADDRESS 2286.....	ERASE ENTIRE PROGRAM	37



