

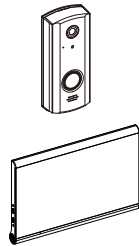

iVision+ Connect



Door station **IVPC-DS**

Mobile station **IVPC-MS**

or a device (not included) running the OPTEx Vision App.

Introduction

This guide covers the installation and setup of the basic IVPC Wireless Intercom System. The basic system contains an IVPC-DS door station and an IVPC-MS mobile station or a device running the OPTEx Vision App.

By the end of the steps, you will be ready to try some of the operations covered in the user manual.

Thank you for choosing OPTEx!

General Information

<< LED indications >>

Power on (Wired operation)		*Low battery Warning	
Power on (Battery operation)		** Low battery error	
Wi-Fi pairing mode		Battery power charging	
Active Call/Live View		Firmware update in progress	
Active Call/Live View (2-way Audio Activated)		*** Device error	

* Low battery warning: The device will cease to function within a week if not recharged
 ** Low battery error: The battery is completely drained. Please recharge immediately.
 *** Device error: Please contact a service provider.

IVPC-DS

Front view

- HD camera
- Light sensor
- Microphone
- LED indicator
- Doorbell button
- Speaker

Rear view (Mounting plate/ back cover removed)

- AC/DC power Input
- External antenna jack
- Internal/external antenna switch
- Internal 5,000 mAh rechargeable battery
- Device ID Back up QR code (Do not remove)

Bottom view

- Open the rubber bushing
- Open the front cover

- Micro USB port (For battery charging)
- Power on/off (Short press to turn power on/off)
- Factory reset (Press & hold for 5 seconds, until white & blue LED starts blinking)
- *Memory card slot (Memory card is installed as a factory default)

* Lift rubber plug for access.

Mounting plate

Back cover

< Accessories >

- Screw pack
- USB charging cable
- Bypass cable
- Cable connector
- Power cable

IVPC-MS

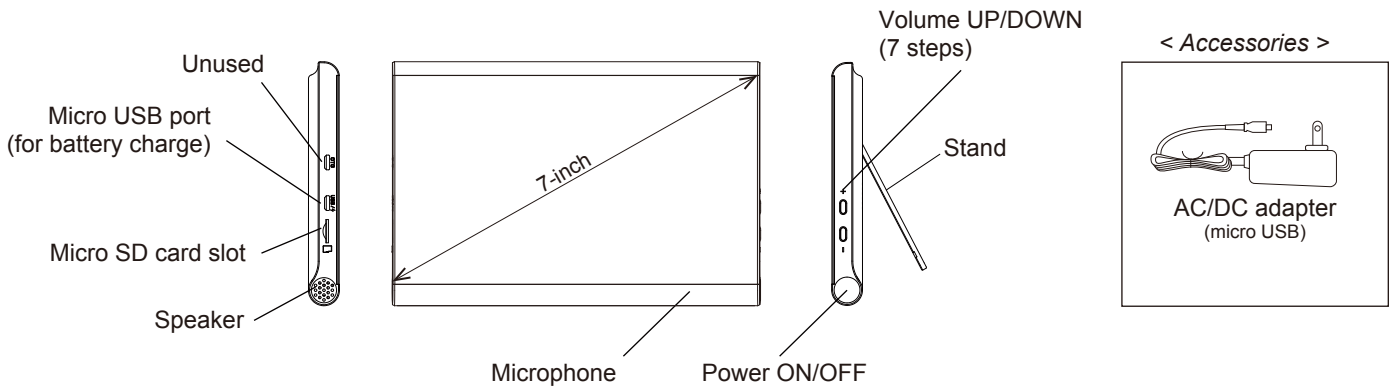

What to expect

- 1 **Collect information;** to register (pair) the IVPC system to the Wi-Fi network.
- 2 **Set up for pairing;** prepare each device for the pairing processes.
- 3 **Pair the IVPC-DS;** pair the IVPC-DS to the IVPC-MS or a device running the OPTEx Vision App and test them.
- 4 **Choose the location;** check the installation site to see if it meets performance needs.
- 5 **Mount the IVPC-DS;** install on the site.
- 6 **Confirm operation;** final check of the operations and customize settings if necessary.

1 Collect information

- Ask the user for the Wi-Fi SSID and password.
Record them on the two lines below.

Wi-Fi router
 SSID; _____
 Password; _____

NOTE For iOS only
 ● When using a device operated by iOS, following password may be required for pairing.
Wi-Fi direct
 SSID; RVDP- xxxxxxxx
 Password; **12345678**

- Peel the Device ID (DID) QR code from the mounting plate of the IVPC-DS and place on the space provided below.
- Note the location name, changed Device password and Admin password set during the installation.
- Hand the user this page when the installation process is finished for their record.

Device password: default 123456

It is used when pairing the IVPC-DS with the IVPC-MS or a device running the OPTEx Vision App. It is necessary to change at the first pairing.

Admin password: default 123456

Used when changing settings. It is necessary to change after the first settings change.

Place DS #1	Place DS #2	Place DS #3	Place DS #4	Place DS #5	Place DS #6
QR Code	QR Code	QR Code	QR Code	QR Code	QR Code

Location name					
Admin. password					
Device password					

2 Set up for pairing

IVPC-DS

1 Loosen the lock screw.

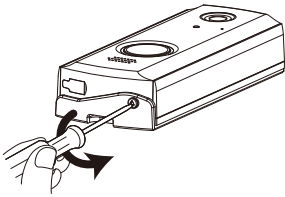

2 Remove the mounting plate.

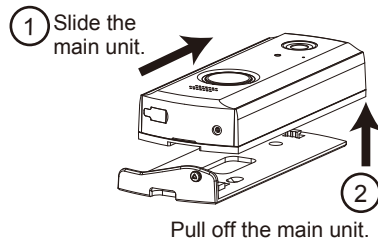

3 Remove the front cover.

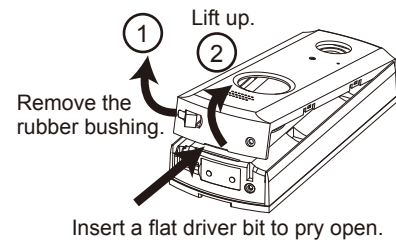

4 Power on.

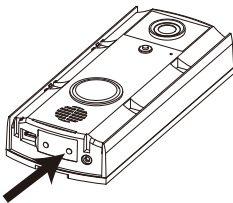

Push the power on/off button.
Confirm LED is flashing blue & white.
This is the pairing mode.
(Hold the factory reset button if not in the pairing mode.)

5 Replace the front cover.

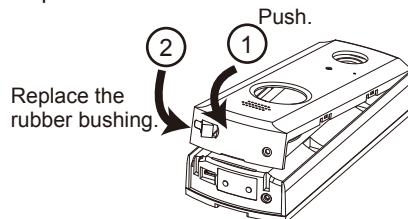

If having trouble with the cover, make sure the bushing is not in the way.

6 Push the front cover to secure.

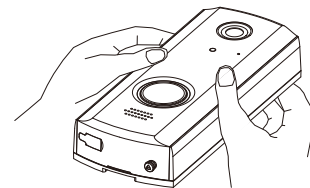

IVPC-MS

1 Plug in.

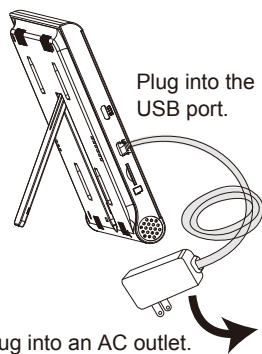

Plug into an AC outlet.

2 Power on.

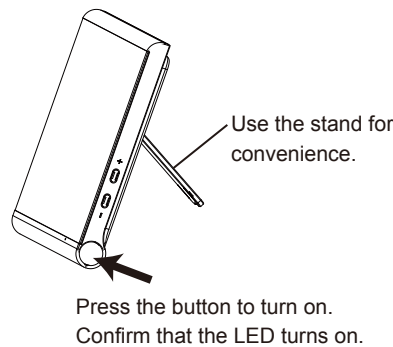

Press the button to turn on.
Confirm that the LED turns on.

3 Wait for startup screen.

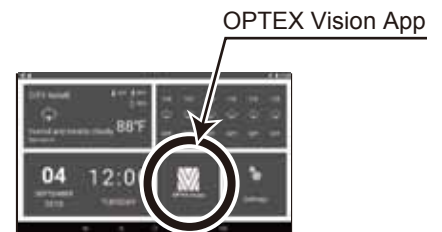

The display shows the startup screen.

Caution Do not use other AC/DC adapter than included.

<< To use the system with a device running the OPTEX Vision App. (option) >>

Download OPTEX Vision

1 Visit either "App store" or "Google play" .



2 Search "OPTEX Vision" in the store.



3 Find "OPTEX Vision" to download it.



An internet connection is required.

3 Pair the IVPC-DS

- Follow the guidance on the screen to register the IVPC-DS to the IVPC-MS.
- Changes can be made using the device and app settings covered in the user manual.

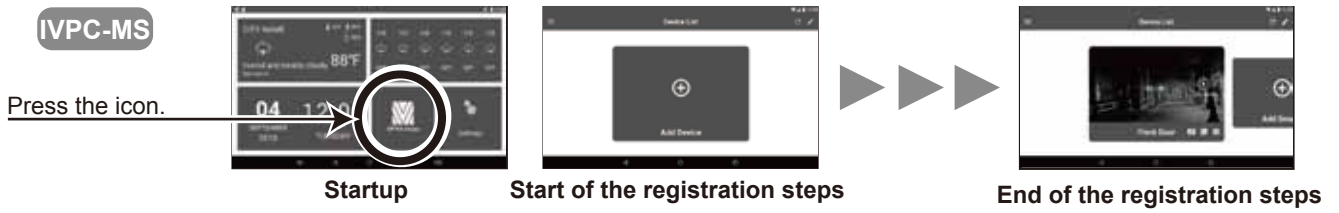

<< To use the system with a device running the OPTEx Vision App. (option) >>

- Follow the guidance on the screen to register the IVPC-DS to a device running the OPTEx Vision App.

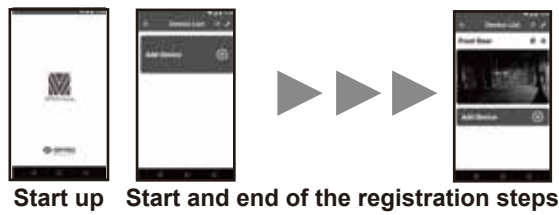

NOTE

- Reference Step 1 or scan the QR code on the back side of the IVPC-DS to get the Device ID.

4 Choose the location

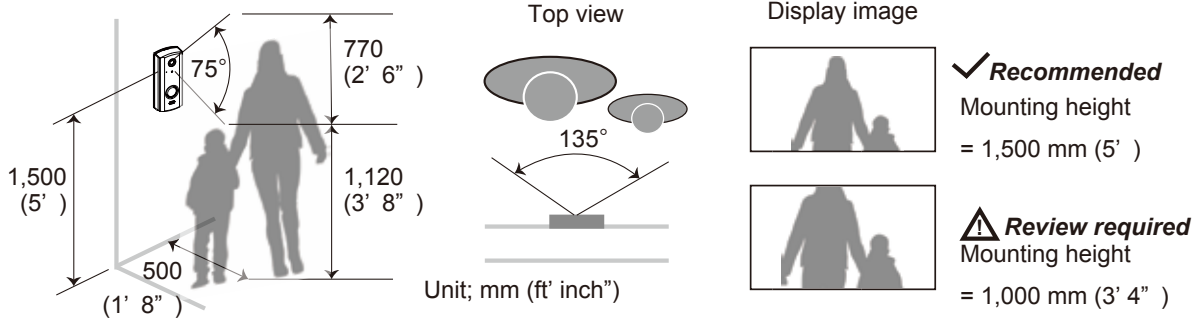

Caution

Consider how lighting may change throughout the day.
Avoid backgrounds with bright lights such as direct sunlight.

<< Confirm good Wi-Fi signal at the location before mounting >>

- 1 Hold the IVPC-DS at the intended mounting place.
- 2 Press the doorbell.
- 3 The IVPC-MS or a device running the OPTEx Vision App should respond confirming Wi-Fi communication with the router.

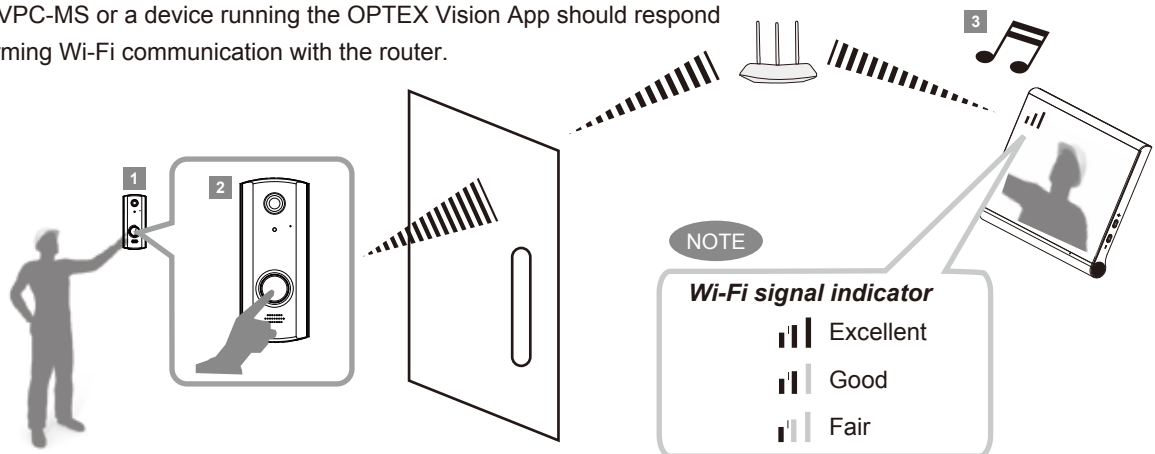

5

Mount the IVPC-DS

- Choose **battery** or **wired operation**.

Battery operation

1 Fix the mounting plate.

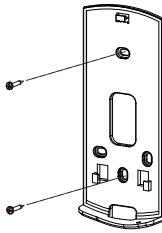

2 Mount the main unit.

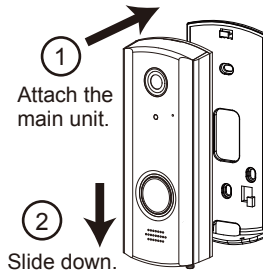

3 Tighten the lock screw.

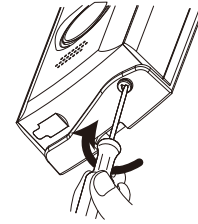

<< Battery charging >>

- Charging not needed for wired operation.
- Use the included USB cable with any USB port power supply or charge station capable of delivering 5 V DC at 1A or greater.
- Full charge time will be approximately 10 hours.

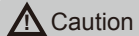

**Please recharge only when temperature is +10°C to +40°C.
(+50°F to +104°F)**

Micro USB port
(For battery charging)

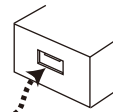
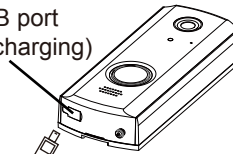

USB port: 5 V 1 A or greater power supply

Wired operation (New installation); 10 to 24 V AC/DC

- See "Retrofit wiring" on the next page, if replacing an existing door chime.

1 Make sure to turn off power.



2 Fix the mounting plate.

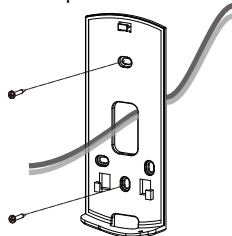

3 Remove the back cover.

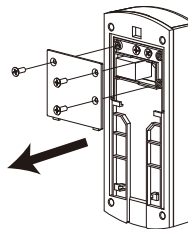

4 Wire the power cables.

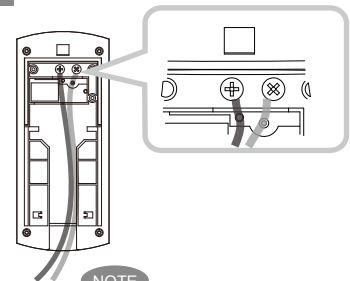

5 Replace the back cover. *1

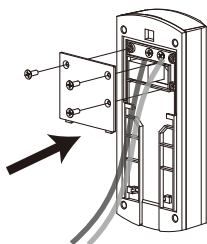

6 Assemble the main unit.

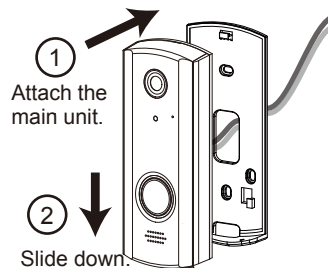

7 Tighten the lock screw.

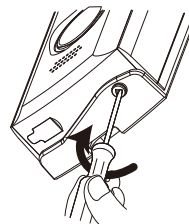

8 Turn on power. *2

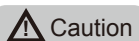

- *1 The back cover protects against water intrusion. Make sure nothing is interfering with it.
- *2 If the power source is kept off, the IVPC-DS is driven by the inner battery. It may cause unexpected system shutdown if power is not restored before the battery depletes.

<< Retrofit wiring >>

- Existing cables and power source for a door chime can be used to power the IVPC-DS.
- Existing door button and chime are not used for this installation.

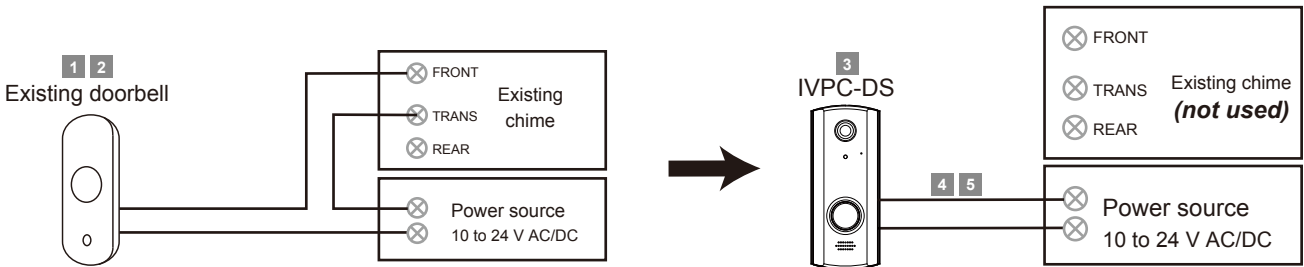

1 Turn off power. Disconnect all wires from the existing chime.



2 Remove the existing doorbell.

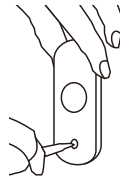

3 Mount the IVPC-DS instead. *1 (Refer to **5 Wired operation**)



4 Connect the power source to the IVPC-DS. If necessary, use the bypass cable (included) for the connection.



5 Turn on IVPC-DS power. *2



⚠ Caution

- *1 The back cover protects against water intrusion. Make sure nothing is interfering with it.
- *2 If the power source is kept off, the IVPC-DS is driven by the inner battery. It may cause unexpected system shutdown if power is not restored before the battery depletes.

6 Confirm operation

After completing installation, follow up with a final operation test:

1. Push the doorbell button on the IVPC-DS to confirm audio and video on the IVPC-MS or a device running the OPTEx Vision App.
2. Go through the settings section of the user manual to customize the settings.
3. Hand this guide and the user manual to the end user for safekeeping.
4. The information from **1** can be used to expand the device network later on.

Reference

Expanding the system

- Refer to the product lineup information in the user manual if unsure of how the system can be expanded.

<< Specifications >>

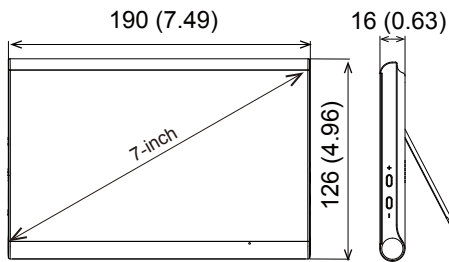
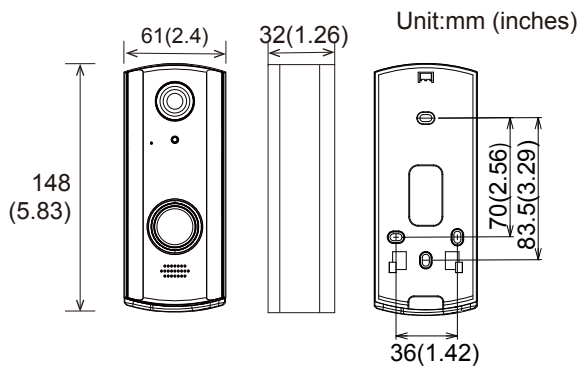

Model		IVPC-DS
Video	Video format	H.264 720p HD/VGA
	Recording file format	MP4
	View angle	H135° / V75°
Audio direction		Two ways (Full duplex)
Wi-Fi	Network connectivity	Wi-Fi 802.11 b/g/n
	Frequency	2.4 GHz
Sub 1 G	Frequency	916 MHz
Power		10 to 24 V AC/DC or Rechargeable battery (included)
Battery life *		2 months/1 year (battery saving OFF/ON)
Battery charging time		10 h with 5 V DC, 1 A supply
Night vision		IR lighting LED
Operating temperature		-20°C to 50°C (-4°F to 122°F)
Operating humidity		< 90% (no condensation)
IP rate		IPX5
Memory card **		microSD card; UHS-I 4 to 32 GB

* at 25°C ** 4 GB microSD card is included.

Model		IVPC-MS
Audio direction		Two ways (Full Duplex)
Wi-Fi	Network connectivity	Wi-Fi 802.11 b/g/n
	Frequency	2.4GHz
Power		AC adapter 5 V/1.5 A
Battery life		Approximate 8 h in standby
Charging time		10 h by included AC/DC adapter
LCD display		7-inch Touch LCD 1,024 x 600
Operating temperature		0°C to 40°C (32°F to 104°F)
Operating humidity		< 90% (no condensation)

- Specifications and designs are subject to change without prior notice.

FCC Statement

This device complies with Part 15 of the FCC Rules. Operation is subject to the following two conditions: (1) This device may not cause harmful interference, and (2) this device must accept any interference received, including interference that may cause undesired operation. Any Changes or modifications not expressly approved by party responsible for compliance could void the user' s authority to operate the equipment.

Note: This equipment has been tested and found to comply with the limits for a Class B digital device, pursuant to part 15 of the FCC Rules.

These limits are designed to provide reasonable protection against harmful interference in a residential installation. This equipment generates, uses and can radiate radio frequency energy and, if not installed and used in accordance with the instructions, may cause harmful interference to radio communications. However, there is no guarantee that interference will not occur in a particular installation. If this equipment does cause harmful interference to radio or television reception, which can be determined by turning the equipment off and on, the user is encouraged to try to correct the interference by one or more of the following measures:

- Reorient or relocate the receiving antenna.
- Increase the separation between the equipment and receiver.
- Connect the equipment into an outlet on a circuit different from that to which the receiver is connected.
- Consult the dealer or an experienced radio/TV technician for help.

Radiation Exposure Statement

This equipment complies with FCC radiation exposure limits set forth for an uncontrolled environment. This transmitter must not be co-located or operating in conjunction with any other antenna or transmitter (see **).

IC RSS warning

This device complies with Industry Canada license-exempt RSS standard(s). Operation is subject to the following two conditions: (1) this device may not cause interference, and (2) this device must accept any interference, including interference that may cause undesired operation of the device. Under Industry Canada regulations, this radio transmitter may only operate using an antenna of a type and maximum (or lesser) gain approved for the transmitter by Industry Canada. To reduce potential radio interference to other users, the antenna type and its gain should be so chosen that, the equivalent isotropically radiated power (e.i.r.p.) is not more than that necessary for successful communication. (1/2) This radio transmitter (identify the device by certification number, or model number if Category II) has been approved by Industry Canada to operate with the antenna types listed below with the maximum permissible gain and required antenna impedance for each antenna type indicated. Antenna types not included in this list, having a gain greater than the maximum gain indicated for that type, are strictly prohibited for use with this device.

IC Radiation Exposure Statement:

This equipment complies with IC RF radiation exposure limits set forth for an uncontrolled environment. This transmitter must not be co-located or operating in conjunction with any other antenna or transmitter (see **).

** For the IVPC-DS, the equipment should be installed and operated with minimum distance 20 cm between the radiator & your body.

Status	Check point	Solution
The registration was not completed successfully. The IVPC-DS will change from blue/white blinking to no light or solid white.	Did something go wrong during the wizard? e.g. Wi-Fi password is incorrect.	Press and hold the factory reset button on the IVPC-DS, to enter the Wi-Fi registration mode. Retry to set each item.
	Communication status with the Wi-Fi router is not good. Or, not connected. Check the communication status between the Wi-Fi router and the IVPC-MS or a smartphone.	Refine the communication state by changing the installation location of the Wi-Fi router. Move the Wi-Fi router closer to the IVPC-DS. Also, an IVPC-ANT (optional External Antenna) is available. A Wi-Fi range extender may expand the Wi-Fi coverage.
	Device is not in device list.	Retry the registration process for the device. Manually enter the Device ID, if necessary.
The chime does not sound even if the doorbell button of the IVPC-DS is pressed (LED does not light).	Power is not supplied to the IVPC-DS. In case of battery operation, check the remaining battery level with the IVPC-MS or a smartphone application. In case of wired operation, check the power supply wiring and voltage.	In case of battery operation, charge the battery. Charging time is about 10 hours with 5 V DC, 1 A supply. In case of wired operation, supply 10 to 24 V AC/DC to the power supply terminals.
Audio is interrupted.	Communication status with the Wi-Fi router may be bad. Check the communication status between the Wi-Fi router and the IVPC-MS or a device running the OPTEX Vision App.	When the communication state is less than fair, refine the communication state by changing the installation location of the Wi-Fi router. Move the Wi-Fi router closer to the IVPC-DS. Also, an IVPC-ANT (optional External Antenna) is available. When the communication state is excellent or good, try raising the volume of the IVPC-MS or a device running the OPTEX Vision App.
The picture is distorted.	Communication status with the Wi-Fi router may be bad. Check the communication status between the Wi-Fi router and the IVPC-MS or a device running the OPTEX Vision App.	When the communication state is less than fair, refine the communication state by changing the installation location of the Wi-Fi router. Move the Wi-Fi router closer to the IVPC-DS. Also, an IVPC-ANT (optional External Antenna) is available.
	Check whether any device that uses 2.4 GHz band such as a kitchen microwave or a baby monitor is located nearby the unit.	Move away from those devices.

NOTE

- Test the total operation after the installation is completed.
- Dispose of used products and batteries should be in accordance with local government regulations/laws.

Warranty

1. This product is under warranty for normal usage for 18 months from the week of the year manufactured which can be identified from the serial number indicated on the label placed in the unit of the IVPC series.

Serial number: YYWWAAAAZZZZ (e.g. 1850502590001)

YY indicates last two digits of the year manufactured (e.g. "18" = Year 2018)

WW indicates the week number of the year manufactured (e.g. "50" = 50th week)

AAAAA indicates the model in 5-digit code (e.g. "50259" = IVPC-DS)

ZZZZ indicates a serial number of the week manufactured

(e.g. "0001" = the first product in the week)

2. The warranty may not be applicable when any of following circumstances is found.
 - Physical or electrical modification is made to the product.
 - Product malfunction is resulting from an improper usage, an accident, natural disaster or any environmental event.
 - Please call our technical support before arranging a return.



OPTEX INC. (U.S.)
URL: www.optexamerica.com

p. 800-966-7839
warranty-returns@optexamerica.com
tech@optexamerica.com



ivisionplusconnect.info/techtips