

CX-ED1079L/DL

'UNIVERSAL' LOW & STANDARD PROFILE ELECTRIC STRIKES



CX-ED1079L/DL AND
STAINLESS STEEL
FACEPLATES

FEATURES

- COMPATIBLE WITH CENTERLINE CYLINDRICAL AND MORTISE LOCKSETS
- CX-ED1079L: SHALLOW DEPTH, 1/2"-5/8" (13mm - 16mm) LATCH PROJECTION (THROW)
- CX-ED1079DL: EXTENDED DEPTH, 5/8"-3/4" (16mm - 19mm) LATCH PROJECTION (THROW)
- FIELD SELECTABLE FAIL SECURE/FAIL SAFE
- DUAL VOLTAGE 12/24V, AC OR DC
- LATCH BOLT MONITORING INCLUDED
- ADJUSTABLE STRIKE BODY
- 3 STAINLESS STEEL FACEPLATES PROVIDED:
 - ANSI SQUARE 4 7/8" x 1 1/4" (123mm x 32mm)
 - HOLLOW METAL DOOR 6 7/8" x 1 1/4" (173mm x 32mm)
 - WOOD DOOR 7 7/8" x 1 3/8" (200mm x 36mm)
- CONTINUOUS DUTY OPERATION
- NON-HANDED
- EASY FIT CONNECTORS FOR POWER & MONITORING WIRES
- TRIM PLATE PROVIDED
- 5 YEAR WARRANTY

DESCRIPTION

Camden CX-ED1079L and CX-ED1079DL grade 1 ANSI strikes for cylindrical and centerline mortise locksets offer the very best strike quality and performance, with the added value of built-in latch monitoring and three stainless steel faceplates. The 'Universal' strike design delivers unparalleled application flexibility, with field selectable voltage, fail safe/fail secure operation and mechanical adjustment of the strike body.

DIMENSIONS

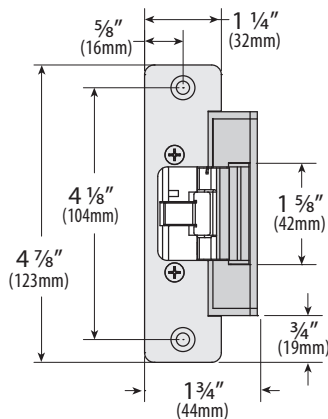

CX-ED1079L

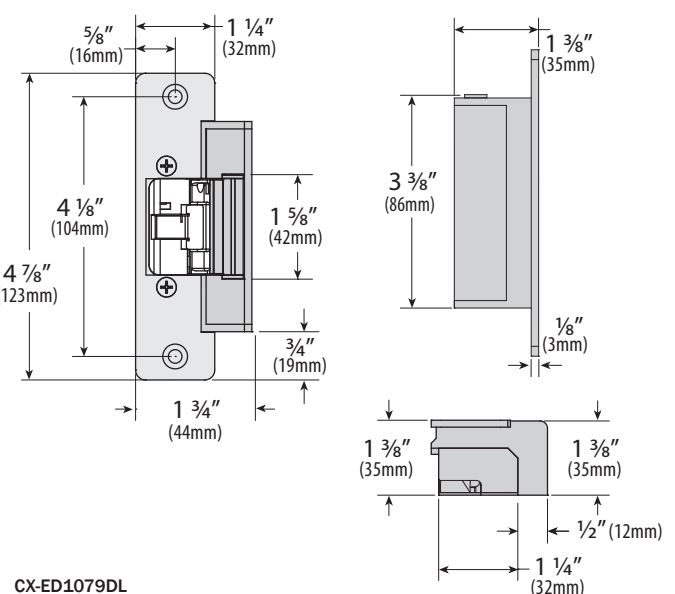
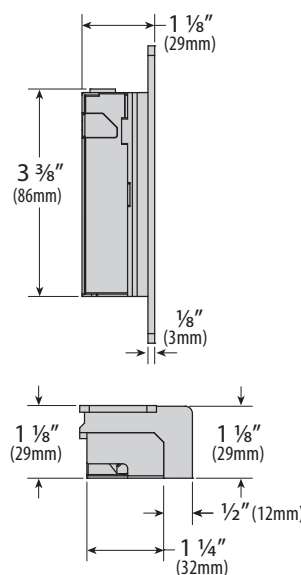

CX-ED1079DL

CX-ED1079L/DL ELECTRIC STRIKES

DOOR FRAME TYPES

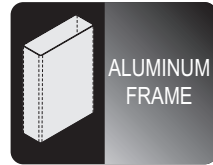
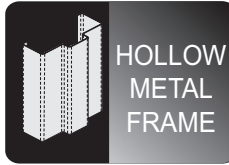

COMPATIBLE LOCKSETS



SPECIFICATIONS

VOLTAGE:	12/24V AC/DC	MECH. ADJUSTMENT:	STRIKE BODY
CURRENT DRAW:	260mA@12V DC, 150mA@24V DC	OPERATION:	AC – BUZZ, DC – SILENT
STATIC HOLD FORCE:	1,500 LBS.	LATCH MONITOR:	LATCH BOLT
DYNAMIC STRENGTH:	70 FT-LBS.	DUTY:	CONTINUOUS
ENDURANCE:	1,000,000 CYCLES (FACTORY TESTED) 250,000 CYCLES (UL VERIFIED)	DIMENSIONS (BODY):	CX-ED1079L: 3 3/8" L x 1 3/4" W x 1 1/8" D (86mm x 44mm x 29mm)
MODE:	FIELD SELECTABLE FAIL SAFE/FAIL SECURE		CX-ED1079DL: 3 3/8" L x 1 3/4" W x 1 3/8" D (86mm x 44mm x 35mm)

ORDERING INFORMATION

CX-ED1079L: LOW PROFILE GRADE 1 'UNIVERSAL' ELECTRIC STRIKE, 12/24V AC/DC, FAIL SAFE/FAIL SECURE OPERATION, HORIZONTAL ADJUSTMENT, C/W LATCH MONITORING AND 3 STAINLESS STEEL FACEPLATES (CX-ESP1B, CX-ESP3B & CX-ESP4B)

CX-ED1079DL: STANDARD DEPTH GRADE 1 'UNIVERSAL' ELECTRIC STRIKE, 12/24V AC/DC, FAIL SAFE/FAIL SECURE OPERATION, HORIZONTAL ADJUSTMENT, C/W LATCH MONITORING AND 3 STAINLESS STEEL FACEPLATES (CX-ESP1B, CX-ESP3B & CX-ESP4B)

FACEPLATES

INCLUDED IN PACKAGE

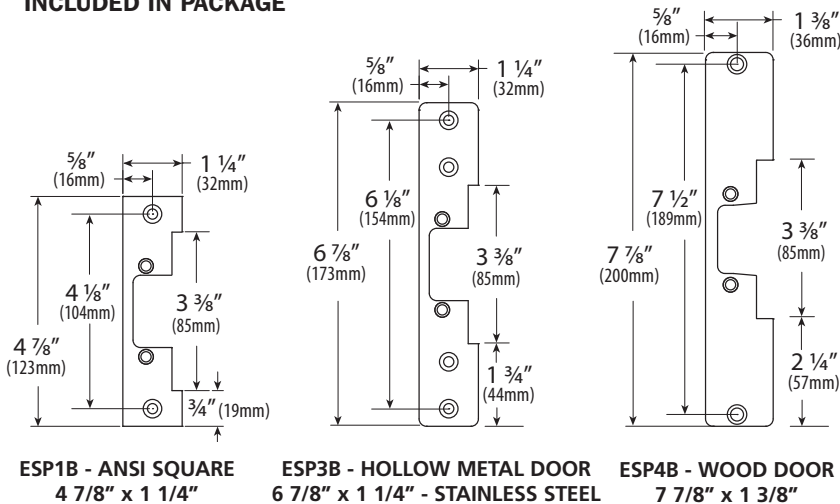

ADDITIONAL FACEPLATE

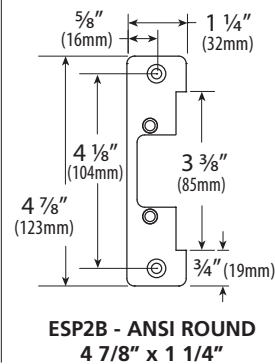

CX-JIG1



CX-ED-LIP1

CUTTING JIGS

- CX-JIG1:** FOR CX-ED1079L STRIKE, ANSI ROUND FACEPLATE (CX-ESP2B)
- CX-JIG2:** FOR CX-ED1079L STRIKE, HOLLOW METAL DOOR FACEPLATE (CX-ESP3B)
- CX-JIG3:** FOR CX-ED1079DL STRIKE, ANSI ROUND FACEPLATE (CX-ESP2B)
- CX-JIG4:** FOR CX-ED1079DL STRIKES, HOLLOW METAL DOOR FACEPLATE (CX-ESP3B)
- CX-JIG5:** FOR CX-ED1079L/DL STRIKES, ANSI AND HOLLOW METAL DOOR FACEPLATES

LIP EXTENSION BRACKETS

- CX-ED-LIP1:**
1" LIP EXTENSION FOR ANSI STRIKES (STACKABLE)
- CX-ED-LIP2:**
2" LIP EXTENSION FOR ANSI STRIKES