

ELK-M1XRFTWM

Two-Way Wireless Transceiver/ Expander
for Elk Two-Way Wireless Sensors.

Refer to page 8 for a listing of sensor part numbers.

INSTALLATION MANUAL

ELK

PRODUCTS, INC.

PO Box 100

3266 US Hwy 70 West

Hildebran, NC 28637

828-397-4200 828-397-4415 Fax

<http://www.elkproducts.com>

Table of Contents

Installation and Setup	4
Diagnostic LED Indicators	5
Setting the Data Bus Address and the Starting Wireless Zone ID.....	5
Data Bus Enrollment::	6
Operation	7
How does the Elk Two-Way technology differ from one-way wireless technology?	7
Installation and Replacement of Batteries in Wireless Sensors::	7
Elk 6000 Series Wireless Sensors	8
'Quick Step' Enrollment of Elk 6000 Series Sensors	9
M1 Keypad Programming for Wireless	10
Appendix A - Data Bus Selection Table	12
Appendix B - Examples of Zone Configurations	13
Appendix C - Installing Multiple Redundant Transceivers	14
Appendix D - Agency Statements	15

FEATURES:

- Adds up to 144 individual wireless zones (sensors/points)
- Operates from the 4 wire RS485 Data Bus
- Multiple Transceivers (Receivers) may be connected to a single Control
- Flash Memory allows field updating of operating Firmware
- Compatible with Elk complete line of Two-Way Wireless Sensors.

SPECIFICATIONS:

- Operating Frequency: 902 Mhz to 928 Mhz
- Transmission Duration (active on-time): 50 ms
- Sensitivity: >105 dbm
- Operating Temperature: 32° F to +120° F (0° C to 49° C)
- Operating Voltage: 12 Volts D.C.
- Current Draw: 25mA Receiving, 85mA Transmitting

NOTE: ELK PRODUCTS IS NOT RESPONSIBLE FOR ANY CHANGES OR MODIFICATIONS NOT EXPRESSLY APPROVED BY THE PARTY RESPONSIBLE FOR COMPLIANCE. SUCH MODIFICATIONS COULD VOID THE USER'S AUTHORITY TO OPERATE THE EQUIPMENT.

OVERVIEW

The letter "M" in the M1XRFTWM receiver part number stands for "**multiple receiver capable**". The previous Elk two way receiver (M1XRFTW) was occasionally installed in multiples on a single installation. The intention and benefit of multiple receivers was for added coverage in super large buildings. It was discovered however that if the multiple receivers were not spaced far enough apart then their overlapping coverage area could cause processor memory overflow if the multiple receivers too often heard the same transmission from one or more sensors. This could then lead to false supervisory troubles or other issues. Not all installations experienced this and some continue to work fine with no issues. It can largely depend on the installation or environmental conditions. This new M1XRFTWM receiver is especially designed to filter out duplicate transmissions and recover from memory issues should they ever occur.

The M1XRFTWM is both a transmitter and a receiver (a transceiver). In other words it has the ability to transmit and receiver thereby making it "two-way". The compatible Elk 6000 series wireless sensors are also two-way, making them vastly superior to traditional one-way wireless sensors. See the listing of available sensors later in the manual. This list is constantly growing and may not be current in this manual due to its printing date. Please contact your local Elk distributor for the latest products and information.

NOTE: In the M1 Keypad Installer programming and the ElkRP programming software you may find conflicting wording with respect to receiver and transceiver. That is because Elk produces two other models of wireless expanders for the M1 Control. The ELK-M1XRFEG † allows M1 to accept Interlogix (aka GE, UTC) one-way sensors. The M1XRF2H † allows M1 to accept Honeywell (aka Ademco) 5800 series one-way sensors. Hopefully this doesn't cause confusion.

Regardless of the model and supported wireless protocol, each receiver connects to the M1 Control via the RS485 four (4) wire Data Bus and becomes enrolled and integrated much the same way as a hardwired expander. Because they are Data Bus attached they may be remotely mounted virtually anywhere in the building, providing maximum convenience and coverage (range). The serial numbers (TXID) for all wireless sensors are stored safely inside the control. Should it ever become necessary to replace a wireless receiver it shouldn't be necessary to reprogram the sensor info. Simply replace the wireless expander and perform a data bus enrollment to allow the M1 Control to begin communicating with it.

VERY IMPORTANT

The M1XRFTWM "two-way" Transceiver must be enrolled as the first zone expander (Address # 2) on the M1 Control Data Bus.

And NO MORE THAN 3 additional M1XRFTWM transceivers may be connected to the M1 for expanded coverage. If added, the 2nd M1XRFTWM transceiver must be enrolled at data bus address 3, the 3rd at data bus address 4, and the 4th at data bus address 5. If there are any other existing model expanders (wireless or hardwire) already installed at one of these needed addresses they must be relocated (moved) to a higher address to make room for the M1XRFTWM(s). See Appendixes A, B, & C for additional details on the use of multiple transceivers.

No bus addresses other than 2, 3, 4, or 5 may be used for M1XRFTWM Transceivers.

Upgrading or retrofitting existing installations - In a retrofit or takeover situation it is possible to mix various models of Elk M1XRFx wireless expanders and their compatible sensors on a single M1 Control. This can be economically beneficial as it prevents having to throw away or replace existing wireless sensors just to utilize another brand. HOWEVER, EXTREME CAUTION must be followed to ensure that each sensor is installed within adequate range of it's respective and compatible wireless expander brand/model. In other words, the sensors and wireless expanders are physically and electronically different. Each sensor can only communicate with its respective wireless expander brand/model.

IN AN INSTALLATION CONSISTING OF MIXED BRAND/MODEL WIRELESS EXPANDERS THE SENSOR BRAND/MODEL MUST BE MATCHED TO THE CORRECT WIRELESS EXPANDER BRAND/MODEL.

We recommend the ELK-M1G Control be running application firmware ver. 5.3.10 or higher. Refer to Elk's website for "flash" file updates.

† Not evaluated by UL

Installation and Setup

INSTALL UNIT * SET ADDRESS AND OPTION JUMPERS * ACTIVATE M1 BUS ENROLLMENT PROCESS

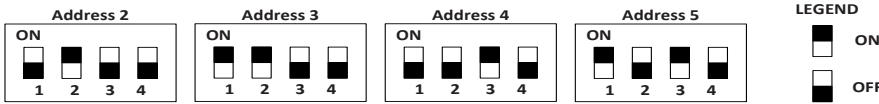

NOTE: ONLY addresses 2, 3, 4, or 5 are permitted to be used with the M1XRFTWM.

Installation must be in accordance with:

- Chapter 2 of the National Fire Alarm Code, ANSI/NFPA 72 and the National Electrical Code, ANSI/NFPA 70.
- UL 1641, Standard for Installation and Classification of Residential Burglar Alarm Systems
- Local Authority Having Jurisdiction
- Wiring methods shall be in accordance with the National Electrical Code, ANSI/NFPA 70.

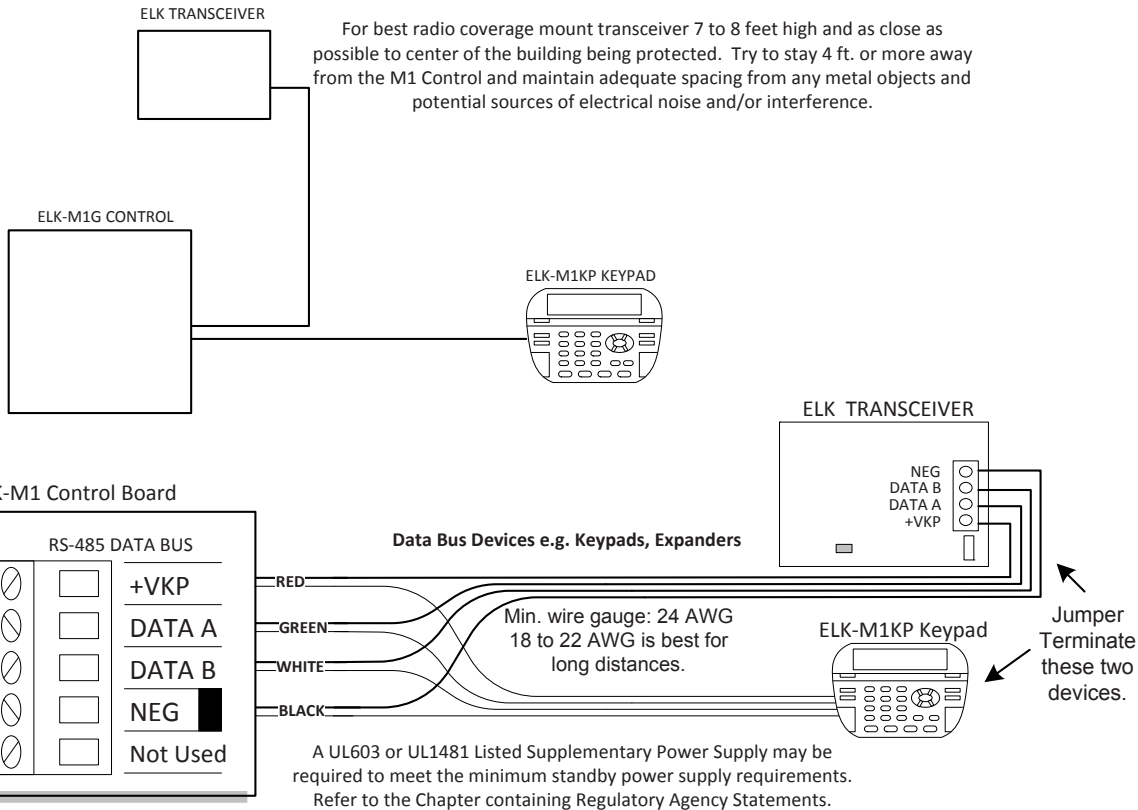

1. **Mounting** - Use two (2) #6 x 1/2" screws (not provided) on each side of the housing for mounting. The Transceiver connects to the Keypad data bus and may be remotely located up to several thousand feet away from the control. NEVER mount inside a metal enclosure or on metalized surface! Space at least 4 to 6 feet from electrical devices that generates noise, including the M1 Control. Electrical noise may negatively affect operation.
2. **Wiring Connections** - Turn the power Off on the Control Panel before making any wiring connections. Connect terminals +12V, A, B, and Neg from the transceiver to the M1's Keypad Data Bus (terminals +VKP, Data A, Data B, & Neg).

NOTE: Refer to the M1 Installation Manual and the M1DBH information in that manual about proper connections of data bus devices with multiple homerun cables.

3. **Antenna** - This device uses a single on-board ceramic antenna. No external antenna is required.

Diagnostic LED Indicators

There are four (4) LEDs on the board that provide valuable information as to the operation of the Transceiver:

STATUS (Data Bus Status) - Multiple conditions exist for this LED:

OFF = No Power to the unit.

ON Solid = Power is good but it is not yet enrolled with the M1 or the Microprocessor is not functioning.

BLINKING = 2 different blink rates:

- Slow "one blink per second" indicates Normal Operating mode.

- Two blips with brief off indicates Bootloader mode. Unit needs to be flash programmed with application firmware. Unit will not be operational until application firmware has been flashed into the unit using ElkRP.

LEARNED RF - This LED indicates that a valid transmitter has sent a signal packet back to the M1 Control.

ALL RF - This LED blinks whenever any transmission is detected in the same frequency as the Transceiver.

DATA BUS ACTIVE - This LED blinks near continuously and indicates activity on the M1 Data Bus.

Setting the Data Bus Address and the Starting Wireless Zone ID

The Transceiver must be addressed and enrolled as the 1st zone expander (Data Bus Address # 2) on the M1 Control. For extended range/coverage up to 3 additional Transceivers may be installed so long as they are enrolled as the 2nd, 3rd, and 4th zone expander ONLY (Data Bus Addresses 3, 4, and 5) on the M1 Control. If another hardwire or wireless expander is presently enrolled at one of these addresses that device must be moved to another address in order to make room for the Transceiver. Refer to Appendixes A, B, & C for more details on the use of multiple transceivers.

Data Bus Address Information: Every device attached to the M1 Data Bus must have a valid address setting within it's device type. TYPE 1 is for Keypads, TYPE 2 is for Hardwire and Wireless Input expanders, TYPE 3 is for Output expanders, TYPE 5 is for Serial expanders. This grouping of devices into different device types allows reduces the required number of address numbers as it allows devices in different groups to share the address numbers. All devices other than keypads utilize a bank of 4 miniature DIP switches for setting their address number. Each switch has an OFF or ON position (binary value 0 or 1) and decimal equiv. value of (1, 2, 4, or 8). The total decimal value of the "ON" switches determines the data bus address. Set the switches to the desired data bus address by referring to Tables 1-1 and 1-2. A small screwdriver may be helpful.

Hardwired Expanders versus Wireless Expanders (Transceivers):

A single Hardwired Zone Expander adds 16 hardwired zones at a time to an M1 Control. The data bus address determines the zones numbers (starting and ending) of that group of 16 zones. See Table 1-1 and 1-2. If additional M1XINs are installed each must be assigned a different address, usually the next available, which sets the zone numbers (starting and ending) of that group of 16 zones.

A single Wireless Transceiver/Zone Expander can add up to 144 wireless zones to an M1 Control. The primary Transceiver must be installed and enrolled at data bus address #2 and the first wireless zone will always be Zone 17. If the full compliment of 144 wireless zones is installed, the last wireless zone would be Zone 160. **No wireless Zones may exist beyond Zone 160.**

No hardwired zone expander should ever be assigned a data bus address that would result in a conflict between a wireless zone and a hardwired zone. In a mixed system of hardwired and wireless zones if any hardwired zone expanders are enrolled in the range of zones 33 through 160 then an entire group of 16 wireless zones is lost for every hardwired (16 zone) expander installed.

WIRELESS Zone Expanders

Data Bus Address	Wireless "Starting Point" Zone 17 up to 160	Switch Settings			
		S1	S2	S3	S4
2	Primary M1XRFTWM	Off	On	Off	Off
3	Opt. 2 nd M1XRFTWM	On	On	Off	Off
4	Opt. 3 rd M1XRFTWM	Off	Off	On	Off
5	Opt. 4 th M1XRFTWM	On	Off	On	Off
6	Zones 81 - 96	Off	On	On	Off
7	Zones 97 - 112	On	On	On	Off
8	Zones 113 - 128	Off	Off	Off	On
9	Zones 129 - 144	On	Off	Off	On
10	Zones 145 - 160	Off	On	Off	On
11	FROM 16 WIRELESS ZONES, UP TO A TOTAL OF 144 WIRELESS ZONES, MAY BE ADDED PROVIDED NO WIRELESS ZONES OVERLAP WITH HARDWIRED ZONES. FROM 1 UP TO A MAXIMUM OF 4 M1XRFTWM TRANSCIEVERS MAY BE INSTALLED.				
12					
13					
14					
15					

HARDWIRED Zone Expanders

Data Bus Address	Starting and Ending Zone Numbers	Switch Settings			
		S1	S2	S3	S4
2	Zones 17 - 32	Off	On	Off	Off
3	Zones 33 - 48	On	On	Off	Off
4	Zones 49 - 64	Off	Off	On	Off
5	Zones 65 - 80	On	Off	On	Off
6	Zones 81 - 96	Off	On	On	Off
7	Zones 97 - 112	On	On	On	Off
8	Zones 113 - 128	Off	Off	Off	On
9	Zones 129 - 144	On	Off	Off	On
10	Zones 145 - 160	Off	On	Off	On
11	Zones 161 - 176	On	On	Off	On
12	Zones 177 - 192	Off	Off	On	On
13	Zones 193 - 208	On	Off	On	On
14	<i>not valid</i>	-	-	-	-
15	<i>not valid</i>	-	-	-	-

Tables 1-1 and 1-2

As shown above zones 17 to 32 are associated with data bus address 2, which is where the primary Elk-M1XRFTWM must be setup and enrolled. Avoid setting up and enrolling hardwired expanders at any of the data bus addresses where a wireless zone might someday be needed.

Data Bus Enrollment::

Once the data bus address is set to "2" and the Transceiver has been powered up then it will be necessary to manually ENROLL the device in order for the M1 Control to recognize it. Data bus enrollment can be done from keypad programming "Menu 1 - Bus Module Enrollment" or from the ElkRP Remote Programming Software.

(The steps below require an M1 LCD Keypad)

1. Press the ELK key, then 9 (or scroll up) to display 9 - Installation Programming. Press the RIGHT arrow key to select this menu.
2. Enter the Installer Program Code. (The default code is 172839)
3. The first Installer Programming menu displayed will be "Bus Module Enrollment"
4. Press the RIGHT arrow key to select this menu. "Enrolling Bus Modules" will display
5. The control will transmit an enrollment message to all data bus devices, followed by a display showing the total Bus Modules that are enrolled. To view the enrolled devices press the RIGHT arrow key next to the word Edit.
6. Press the * or Exit keys to exit Installer Programming.

**Auth. Required
Enter Valid Pin**

**01-Bus Module
Enrollment**

**XX Bus Modules
Enrolled, Edit**

Important considerations when installing an M1XRFTWM:

- A single M1XRFTWM Transceiver expander is capable of supporting up to 144 wireless Sensors/Zones.
- Wireless zones are always allocated in Groups of 16 but it is not necessary to install or use all 16 zones in the group. However it is important to understand that NO HARDWIRED zones can exist at any of these zone number locations.
- Take special care to ensure that NO wireless zone numbers spill over into data bus addresses that are already assigned to a M1XIN Hardwired Zone Expander, or vis versa. It may be necessary to move a hardwired expander and its related zones up higher in the numbering scheme just to make room for a group of 16 wireless zones.
- Elk strongly recommends that all wireless zones be assigned consecutively. The wireless group numbers AND the associated data bus addresses will also be consecutive. Do not mix hardwired zone expanders in between groups of wireless zones. Data bus addresses that are potentially vulnerable to this are addresses 2,3,4,5,6,7,8,9, & 10 since these addresses are the only locations where the wireless zones (17 thru 160) can exist.
- Zone 160 is the highest wireless zone number allowed. Wireless zones cannot exist in the range of 161 through 208.
- If a large number of wireless zones is ever anticipated then it would be wise to AVOID any of these potentially overlapping data bus addresses (zones) when assigning a hardwired expander.

Example: To install an M1 Control with 64 wireless zones the first zone will begin at Zone #17 since the M1XRFTWM must be assigned at data bus address 2. Starting from 17 then adding 64 zones results in the last wireless zone being zone #80. And zone #80 is the last zone in the data bus address #5 location. So the next or first available data bus address for a hardwired zone expander would have to be data bus address #6. NO HARDWIRED ZONE EXPANDER COULD BE SET to data bus addresses 2, 3, 4, or 5. Each of those data bus addresses are reserved for the 64 wireless zones.

NOTE: Please anticipate whether the system may someday require more wireless or hardwired zones. If the answer is yes then it would be wise to plan the data bus address assignments in such a way that future growth is possible without having to default the control or totally re-arrange the addresses at a future date.

Operation

How does the Elk Two-Way technology differ from one-way wireless technology?

Elk's Two-Way technology is superior to traditional one-way wireless products in many ways.

1. Every signal sent by an Elk two-way sensor receives a positive acknowledgment from the transceiver. *One-way systems have the reputation of being "fire and pray".*
2. Elk two-way sensors only send one signal at a time. *One-way sensors have no choice but to blindly send multiple signals in hopes that at least one will reach the receiver.*
3. Long battery life and energy efficiency are inherent designs of the Elk two-way sensors. Elk two-way sensors only need to re-transmit if they get not response from the transceiver.
4. Long range coverage is possible due to the 900 MHz frequency range and automatic frequency hopping design. *One-way systems operate at a specific, non-adjustable lower frequency.*
5. A two-color LED indicator on the sensor provides operational feedback. A single Green blink means the transmission was sent and positively acknowledged by the transceiver. A Red blink means the sensor was unable to receive an acknowledgment from the M1XRFTWM transceiver. *One-way sensors provide no indication of signal verification.*
6. Installation confidence. All Elk 6000 series sensors artificially limit their RF power to 50% of normal for the first 10 minutes after battery installation. This "stress test" helps to assure that a sensor's mounting location and range is suitable for long term reliability. The principle is that a sensor that is able to reliably communicate using half the normal power will have a high degree of reliability with full 100% power. *Other sensor brands do not provide this confidence feature.* To take full advantage of this feature we recommended that every sensor be temporarily installed at its intended location and violated (tripped) multiple times while observing the two-color LED indicator. A near instant GREEN blink response from the sensor is Ideal. The sensor will repeatedly attempt to reach the receiver for up to 20 seconds, but any time it takes more than just a few seconds to get through it means that the mounting location is poor. Therefore, we strongly suggest reorienting the sensor to another spot on the mounting surface, or rotating its mounting by 90 degrees whenever it takes more than a few seconds to get a GREEN acknowledge. Excessive range and poor wireless conditions will always result in a delay of the GREEN blink. A Red blink means the sensor was unable to receive an acknowledgment from the M1XRFTW transceiver. NOTE: In extreme situations it may be necessary to relocate the transceiver to a closer spot or to add an additional remote transceiver to cover distant sensors.

NOTE: The Green Acknowledge LED does not operate for sensor restoral transmissions.

Programming tools needed for the M1XRFTWM Transceiver and Sensors.

There are no special tools required for Elk's two-way wireless product line. The Transceiver itself and the sensors may be programmed using either the M1 Keypad Installer Programming or the ElkRP Remote Programming software. The following pages document the options and steps for programming from the keypad.

Installation and Replacement of Batteries in Wireless Sensors::

A Low Battery trouble will be sent to the Control whenever a sensor determines that its battery needs to be replaced. This will generally occur well in advance of the battery becoming completely dead. However, it is up to the customer to ensure that the Low Battery trouble is responded to and rectified in a timely manner so that the system can continue to operate.

When replacing a Low Battery:









1. Remove the old battery and **WAIT AT LEAST 20 SECONDS** before installing the new battery. This is important as it allows the sensor circuitry to completely shutdown and erase the low battery memory.
2. After **20 seconds**, install the new battery, then trip the sensor a couple of times so that an "all good" signal will be sent to the control to clear the low battery trouble.

Elk 6000 Series Wireless Sensors

Enrollment and programming of wireless devices may be done from Keypad Installer Programming or from ElkRP

Enrollment from Keypad Installer Programming utilizes Menu 14 and the LRN (Learn) method. The enroll method varies between sensors. Please follow the specific enroll method suggested below and read the additional programming recommendations.

Enrollment from the ElkRP software involves typing in the TXID (serial number of the sensor) along with selecting the particular attributes.

Image	Part Number(s) & Description	Keypad Enroll Method	From Keypad Installer Programming use Menu 14, sub-menu 3: Lrn Sel Wireless Transmitter. Follow the published Enroll Method procedure and other steps as listed below.
	Elk6010 † Keychain Remote (FOB), 4 buttons with System Status Inquiry	Enroll Method 3	Set the Supervision Type as "0". This is mandatory! Use Menu 14, sub-menu 2:Xmit Transmitter Opt. Program the Zone Def. as 15-KEYFOB using Menu 5:Zone Definitions. Key (button) functions may be modified using Menu 14, sub-menu 4:KeyfobSel Event Definition. By factory default key (button) 1=Arm, 2=Disarm, and 3=Inquiry (System Status). Keys (buttons) 1,2,3,4 may be converted to respond as 5,6,7,8 by enabling Option 1 using Menu 14, sub-menu 2:Xmit Transmitter Opt. <u>Loop # = {For keychain remotes the Loop # does not matter}</u>
	Elk6020 † Slim Door & Window Sensor, Front/Back Tamper	Enroll Method 1	<u>Loop # = 2</u> This sensor has a built-in reed switch and provides a single zone (input). When enrolled into a factory defaulted zone location the M1 should recognize this sensor on the default loop value of 0. I.E. It should not be necessary to change (reprogram) the Loop from 0 to 2. However if this sensor is being enrolled into a location previously occupied by another sensor, care must be taken to be certain the Loop gets changed to Loop # 2 or else the sensor may not operate.
	Elk6021 † Mini Window Sensor, No Tamper	Enroll Method 1	<u>Loop # = 2</u> This sensor has a built-in reed switch and provides a single zone (input). When enrolled into a factory defaulted zone location the M1 should recognize this sensor on the default loop value of 0. I.E. It should not be necessary to change (reprogram) the Loop from 0 to 2. However if this sensor is being enrolled into a location previously occupied by another sensor, care must be taken to be certain the Loop gets changed to Loop # 2 or else the sensor may not operate.
	Elk6022 † Universal 3-Zone Dr/Wnd Sensor, 1 Reed + 2 Aux., Front/Back Tamper	Enroll Method 2	This Sensor has a built-in reed switch PLUS 2 external inputs providing a total of 3 zones. For each input used the sensor MUST be enrolled as a separate wireless zone. <u>The TXID will be the same for each.</u> Loop # = > The Loop # directs which input on the sensor is assigned to each wireless zone. On the zone utilizing the built-in reed set the Loop # to 2. On the zone utilizing the Aux. LP1 terminals set the Loop # to 1. On the zone utilizing the Aux. LP3 terminals set the Loop # to 3. This is very IMPORTANT! Normally Open (N/O) contacts may be used with the Aux. Inputs LP1 & LP3 by enabling Option 2 under Menu 14, sub-menu 2:Xmit Transmitter Opt. For additional information see instructions packed with sensor.
	Elk6023 † Recessed Door Sensor with Cover Tamper	Enroll Method 1	This Sensor has a built-in reed switch and provides a single zone (input). When enrolled into a factory defaulted zone location the M1 should recognize this sensor on the default loop value of 0. I.E. It should not be necessary to change (reprogram) the Loop from 0 to 2. However if this sensor is being enrolled into a location previously occupied by another sensor, care must be taken to be certain the Loop gets changed to Loop #2 or else the sensor may not operate.
	Elk6030 † PIR Motion Sensor with Security/ Convenience Light	Enroll Method 1	<u>Loop # = 2</u> This is a single zone sensor. During enrollment it is very important that the Loop number be set to Loop # 2. <u>This sensor WILL NOT operate unless the Loop # is set to 2.</u>
	Elk6030P † PIR "Pet Immune" Motion Sensor with Security/ Convenience Light	Enroll Method 1	<u>Loop # = 2</u> This is a single zone sensor. During enrollment it is very important that the Loop number be set to Loop # 2. <u>This sensor WILL NOT operate unless the Loop # is set to 2.</u>
	Elk6040 Glass Break Sensor	Enroll Method 1	<u>Loop # = 2</u> This is a single zone sensor. During enrollment it is very important that the Loop number be set to Loop # 2. <u>This sensor WILL NOT operate unless the Loop # is set to 2.</u>
	Elk6050 Photoelectric Smoke Detector with built-in Sounder	Enroll Method 1	<u>Loop # = 2</u> This is a single zone sensor. During enrollment it is very important that the Loop number be set to Loop # 2. <u>This sensor WILL NOT operate unless the Loop # is set to 2.</u>

† Not evaluated by UL

'Quick Step' Enrollment of Elk 6000 Series Sensors

Enrolling Sensors from the M1 Keypad Installer Programming (additional details on following pages)

NOTE: The M1XRFTWM must be enrolled on the data bus at address 2.

1. From M1 Keypad Installer Programming scroll or navigate to Menu: **14-Wireless Setup**
2. Press right arrow and scroll up to Sub-Menu: **3:Learn Sel Prg Wireless Transmtr**
3. Press right arrow **WZone** and search or scroll to the first available (unused) location displaying **TransmtrToLrn**. An existing or already enrolled location will display **Enrolled** followed by a 6 digit TXID number of the enrolled sensor.
4. After finding an available wireless zone location press the right arrow to **Lrn (Enroll)** a sensor into this location.
5. The keypad will display **Push Transmitter Button** and the M1G will announce: **"Press transmitter button for zone __"**. On successful enrollment the keypad will chime and the TXID will briefly display. The M1G will announce: **"Zone __ Enrollment"**. The **Rapid-Enroll** feature will advance to the next available wireless zone in sequence and wait for another sensor to be enrolled. The M1G will announce: **"Press transmitter button for zone __"**. The Rapid-Enroll may be exited by pressing the ELK key.

ENROLL METHOD 1 -

- A. **Insert Battery** in the Sensor while M1 is displaying **"Push Transmitter Button"**. **If battery is already installed then remove it and wait 5 seconds before re-inserting.**
- B. Upon successful enrollment the Keypad will chime and briefly display the 6 digit TXID code of the Sensor.
- If enrollment FAILS the TXID will not display. If that happens then remove the battery, wait 5 seconds, then re-insert.

ENROLL METHOD 2 - For Sensors with Multiple Zone Inputs. The enrollment must be repeated for each additional Zone Input. The TXID will be the same for each. We strongly recommend enrolling the additional zone(s) in sequence with the 1st.

- A. For the internal reed switch Zone (LP2) insert the Battery into the Sensor while M1 is displaying **Push Transmitter Button**.
- B. Upon successful enrollment the Keypad will chime and briefly display the 6 digit TXID code of the Sensor.
- If enrollment FAILS the TXID will not display. If that happens then remove the battery, wait 5 seconds, then re-insert.
The **Rapid-Enroll** feature will auto advance to the next wireless zone.
- C. To enroll the next Zone (marked LP1) on this sensor REMOVE the Battery and wait 5 seconds. Then re-insert Battery into the sensor. Repeat this step to enroll the next Zone (marked LP3).
- D. The Loop # must be programmed uniquely for each input since the TXID will be the same for all 3 available wireless zones.

ENROLL METHOD 3 - KEYCHAIN REMOTES †

- A. PRESS and HOLD button 1 or button 2 while M1 is displaying **Push Transmitter Button**.
- B. Upon successful enrollment the Keypad will chime and briefly display the 6 digit TXID code of the Sensor.
- If enrollment FAILS the TXID will not display. If that happens then remove the battery, wait 5 seconds, then re-insert.

NOTE: If the M1 Lrn (Enroll) function times out or is manually exited then It may be necessary to restart from Step 1

6. To end **Rapid-Enroll** once all wireless zones (sensors) have been enrolled, press the ELK key one time.
7. **Loop #** - Refer to the "Elk 6000 Series Wireless Sensors" chart for more information on the loop setting of each sensor. For single internal reed sensors the Loop # setting will be 2. It is VERY IMPORTANT to follow the directions outlined in the referenced chart and set the Loop # correctly. To set the Loop # scroll up or down to the desired M1 wireless zone and press the left arrow. The screen will display a 9 digit number (the TXID in decimal) followed by **Loop=**. Press the right arrow and move cursor over to **Loop=**.
8. Program the Zone Def. using **Menu 5: Zone Definitions**.

Enrolling Sensors from the ElkRP Software

1. Launch ElkRP and open the desired Customer Account file.
2. If no wireless zones currently exist in the M1 you will first need to create a group of 16 wireless zones. In the folders column right click on **Zones (Inputs)**, then click **New Wireless Zones**. Select Group 2. **NOTE:** The first M1XRFTWM must be enrolled at data bus address 2, therefore the first wireless zone will always be Zone 17 which resides in Group 2. Additional groups of 16 zones may be added as required. If a hardwired zone expander is occupying address 2 it will have to be relocated to another address so that the M1XRFTWM can be at address 2. Up to 3 additional M1XRFTWM Transceivers may be added for expanded coverage. If so, they must be enrolled at addresses 3, 4, and 5 respectively. If a large quantity of wireless zones is expected, avoid enrolling hardwired expanders in data bus addresses below 10. This will allow for the maximum of 144 wireless zones.
3. Program the Zone Definition, Name, Type, and desired options by clicking on: **Wireless Group** (the group just added). Then select each zone one at a time to program. Zones definitions may be assigned before or after sensor enrollment.
4. To enroll the sensors click on: **Wireless Setup** from the folders column.
 - A. Click the **> Transmitters** tab, then double click a zone.
 - B. Place a check mark in the **Enabled** box.
 - C. Set Supervision type as either: **0=Non Supervised (Keyfobs)**, **1=Normal "Burg" Supervision**, or **2=Fire Supervision**
 - D. **TXID #** - type in the Sensor TXID printed on the label on the inside and outside of the sensor.
 - E. **LOOP #** - Refer to step 7 above and the "Elk 6000 Series Wireless Sensors" for more information.
 - F. Click **Save**. Repeat the entire step 4 for each additional Wireless Sensor.

IMPORTANT! For sensors with multiple zone inputs the enrollment must be repeated for each additional Zone Input and the TXID will be the same for each. We strongly recommend enrolling the additional zone(s) in sequence with the 1st. The Loop # must be programmed correctly to identify which zone input belongs with which wireless zone.

† Not evaluated by UL

M1 Keypad Programming for Wireless

From the keypad enter the Installer Level Programming mode. Press ELK, 9 > (enter installer code). Navigate to the Wireless Setup - Menu 14 and press the RIGHT arrow key to select.

14-Wireless Setup ▶

Wireless Submenu

1:Rec Sel ◀ Prg▶ Receiver Options

RO3:=024 Hours ▶
Reg. Supervision

RO4:=004 Hours ▶
Fire Supervision

R O 5 : = N o ▶
UL Wireless-Jam

2:Xmit Sel ◀ Prg▶ Transmitter Opt ▶

WZn017:Sel ◀ Prg▶
Wireless Zone

WZn017 01: =No ▶
Enable Transmitt

WZn017 02: = 0 ▶
Supervision Type

WZn017 03: = No ▶
Enable Option 1

WZn017 04: = No ▶
Enable Option 2

WZn017 05: = 001 ▶
Keyfob User ID

WZn017 06: = No ▶
PIR Auto Restore

There are four (4) wireless setup submenus: 1-Receiver (Transceiver) Options, 2-Xmitter Options, 3-Xmitter Enroll, and 4-Keyfob Event Definitions. Use the UP or DOWN arrow keys to locate the desired submenu, then press the right arrow key to select.

Description

This submenu is for Receiver (Transceiver) options. To select this menu press the RIGHT arrow key, or press the Up or Down arrow keys to scroll the submenus.

Sets the expiration timeout value for supervision of zones assigned as Supervisory Type 1 (Non-Fire Zones). The range is 001 to 255 hours and the default is 024 hours. If a Type 1 sensor fails to check-in prior to this timeout it will be declared missing. The Type is assigned to each transmitter (sensor) under Transmitter Opt 02 (see below).

Sets the expiration timeout value for supervision of zones assigned as Supervisory Type 3 (Fire Zones). The range is 001 to 255 and the default is 004 hours. Should a Type 3 sensor fail to check-in prior to this timeout it will be declared missing.

For UL listed installations with the Elk-M1XRFTWM Transceiver this option should be enabled. A trouble indication will occur if an attempt is made to jam the wireless frequency. This will also cause the M1 to intentionally violate all wireless non-armed zones and trouble all wireless fire zones if the M1XRFTWM Transceiver ever becomes inoperable or missing

This submenu is for specific transmitter (sensor) options. To select this menu press the RIGHT arrow key, or press the Up or Down arrow keys to scroll to another submenu.

Use the UP and DOWN arrow keys to locate a particular wireless transmitter. Press the RIGHT arrow key to select and program the displayed transmitter.

Displays if a transmitter is enabled or disabled. This option CANNOT be used to add a new device, but it can be used to temporarily suspend or remove an already enrolled device. When a new sensor is added via the enroll process this location will be set to Yes.

This sets the expected check-in (supervision) interval of a sensor. Burglar (non-fire) sensors should be set as "1"=Normal Supervision. Fire Sensors should be set as "3" = Fire Supervision. **CAUTION! Keychain Remotes † (Fobs) or sensors that leave the building MUST be set to "0" = non supervised.** See receiver selections R02 and R03 for supervision time values. Valid values are: 0, 1, or 3 Factory default setting is 1 (Normal Supervision).

This is relevant to a few select sensors. Factory default is No. **See the List of Elk 6000 Series Wireless Sensors to determine which transmitters use this option.**

This is relevant to a few select sensors. Factory default is No. **See the List of Elk 6000 Series Wireless Sensors to determine which transmitters use this option.**

This location allows a number to be assigned as the User ID that will appear in the M1 event log whenever a Keychain Remote † is used to arm/disarm. Valid range is 001 to 255. NOTE: Standard M1 User codes are 001 to 199.

This option (PIR Auto Restore) is not currently used by the M1XRFTWM.

WZn017 shown as an example only!

† Not evaluated by UL

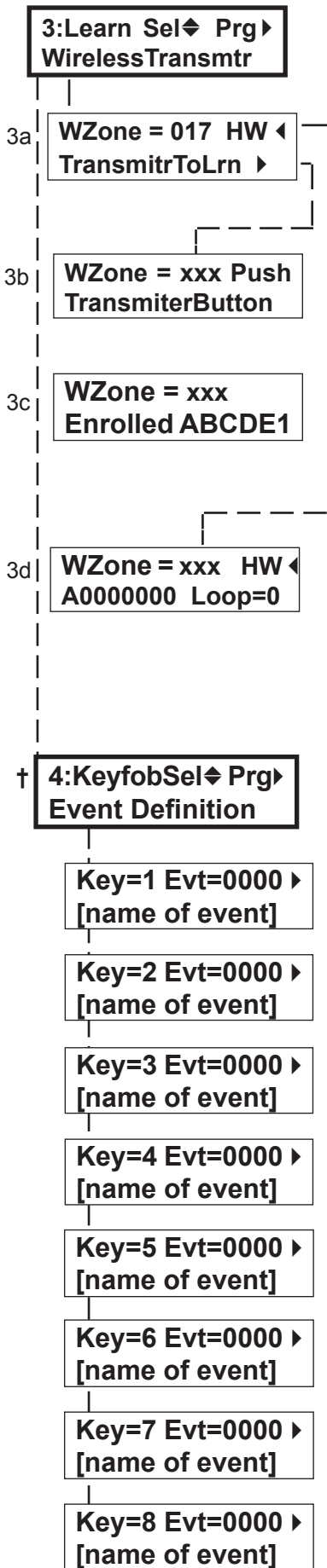

This submenu is used to manually enroll transmitters (sensors). To select this menu press the RIGHT arrow key, or press the Up or Down arrow keys to scroll submenus.

Select the zone for the new transmitter (sensor) by entering the three (3) digit zone number OR by scrolling to the zone number using the UP and DOWN arrow keys. NOTE: If a transmitter is already enrolled for this zone the display will resemble 3c below. Otherwise, it will display "TransmtrToLrn".

WZone = 17 shown as example

Press the RIGHT arrow key to select and program the zone.

As this message is displayed the M1 will speak: "Press Transmitter Button for Zone XXX". Go to the transmitter (sensor) and execute the enroll process according to the sensor instructions. In most cases this requires inserting the battery. If successful the keypad will chime and M1 will speak: "[Zone Number/Name] Enrollment." Refer to step 3c below.

The TXID of the newly enrolled transmitter (sensor) will momentarily display. Rapid Enroll will then auto-advance to the next zone (step 3b) to permit sequential enrollment of transmitters. Press the ELK key twice to exit the enrollment after all new sensors have been enrolled.

DELETING A WIRELESS SENSOR - To delete an existing sensor navigate to option "WZnxxx 01" and select "No". NOTE: Manually setting the Loop to 0 will also delete a sensor.

SETTING THE LOOP #. Refer to the "Elk 6000 Series Wireless Sensors" chart for more information on the loop setting of each sensor. For single internal reed sensors the Loop # setting will be 2. It is VERY IMPORTANT to follow the directions outlined in the referenced chart and set the Loop # correctly. From step 3a press the Keypad LEFT arrow marked "HW". The TXID in decimal notation will display on the lower left. Press the RIGHT arrow to move the cursor over to Loop =. Enter 1, 2, or 3 according to the sensor instructions. Refer to the "Elk 6000 Series Wireless Sensors" for more information.

This submenu is used to program the operation or "action" for Keychain Remote † (FOB) buttons. Each button can be assigned one of six (6) separate operations as explained below. To select this menu press the RIGHT arrow key.

Press the UP or DOWN arrow keys to select a key (button) 1 to 8. Some models may not support all the programmable buttons. The event or operation for each button is set by a four (4) digit event code. The range of event codes is 0000 to 0030 See M1 Installer Manual, Appendix A, Event Codes.

Factory default = Only keys (buttons) 1 and 2 have a default setting.

Key (Button) & Symbol	M1 Factory Default Event & Operation
Key1 - Lock	Event=0027 - KeyMomAway (Arm the Control)
Key2 - Unlock	Event=0029 - KeyMomDisarm (Disarm the Control)
Key3 - <i>i</i> Status Inquiry	Event=0000 - unprogrammed See NOTE 1 below
Key4 - Red Triangle	Event=0000 - unprogrammed See NOTE 2 below

NOTE 1: Key (button) 3 on a 6010 Keychain Remote ALWAYS performs a system status Inquiry when pressed momentarily. This same key may be pressed and held for four (4) seconds to activate M1 programmable Key3 event. Factory default is 0000 (do nothing)

NOTE 2: Key (button) 4 on a 6010 Keychain Remote REQUIRES a press and hold for two (2) full seconds in order to activate M1 programmable Key4 event. This can be any event, however the most common use is for emergency panic (Police Panic event 0023 or 0024). Factory default is 0000 (do nothing)

DOUBLE KEY (BUTTON) PRESSES

M1 programmable Key7 event may be triggered by pressing the top 2 keys (buttons) together for ~3 seconds, and Key8 event may be triggered by pressing and holding the bottom 2 keys.

SWAPPING THE KEY (BUTTON) FUNCTIONS

The M1 programmable keychain events are GLOBAL for all units. While it is not possible to fully customize the keys for multiple persons, it is possible to swap keys 1,2,3,4 to become keys 5,6,7,8. This allows 2 different remotes or people to activate different events. Enable Option 1 from **Menu 14, sub-menu 2:Xmit Transmitter Opt.**

† Not evaluated by UL

Appendix A - Data Bus Selection Table

This table should help visualize how the Wireless Zones and Hardwired Zones share the data bus address assignments. Please note that **No Wireless Zones Are Allowed Above Zone 160**. This table shows the starting wireless Zone # and data bus address along with the additional data bus addresses and Zone #'s necessary to obtain the total and best mix of wireless and hardwired zones. The left column indicates the total maximum wireless zones that may be obtained based on the data bus addresses chosen.

1. The bolded column indicates that the 1st M1XRFTWM Transceiver must be at data bus address 2. This also means that the first wireless zone will be Zone #17.
2. If possible, try to determine how many total wireless zones might ever be needed now or in the future on this installation. And be sure to also consider the possibility of future hardwired zones and M1XIN hardwired expanders in the future.

NOTE: The total (max.) number of wireless zones will be decreased by 16 zones for any hardwired expanders installed and enrolled in the data bus addresses at or below Addr 10. The reason is that only zones 17 to 160 can be used for wireless zones, and data bus addresses 2 thru 10 correspond to zones 17 to 160.

It is strongly recommended that all wireless zones be sequential, with no hardwired zones interspersed between them.

The following are suggested guidelines:

- If there is any possibility that additional wireless zones might be needed in the future, consider leaving a gap of 1 or more data bus addresses between the M1XRFTWM data bus address belonging to the last wireless zone and any M1XIN hardwired zone expanders.
 - If there is little or no likelihood of additional wireless zones being required, the 1st hardwired zone expander can be If setup and enrolled at the first available data bus address right after the last wireless zone
3. Start down the left column and pick the line that represents the maximum number of wireless zones required. Follow this row across to find the first column indicating "hardwired". The top of this column shows the data bus address where an M1XIN Hardwired Zone Expander may be enrolled.
 - Up to 3 additional "redundant" M1XRFTWM Transceivers may optionally be installed at data bus addresses 3, 4, & 5. Redundant Transceivers may be remotely mounted and wired back to the M1 Control to provide additional range and coverage in extremely large or difficult buildings. See Appendix C regarding Redundant Transceivers.

NOTE: The only benefit to using multiple transceivers is added range/coverage. They do not increase the number of wireless zones.

Total Wireless Zones Desired (max.)	Primary (1 st) M1XRFTWM must be at Data bus Addr 2 Zones 17-32	Data Bus Addr 3	Data Bus Addr 4	Data Bus Addr 5	Data Bus Addr 6	Data Bus Addr 7	Data Bus Addr 8	Data Bus Addr 9	Data Bus Addr 10	No Wireless Zones Here		
		Zones 33 - 48	Zones 49 - 64	Zones 65 - 80	Zones 81 - 96	Zones 97 - 112	Zones 113-128	Zones 129-144	Zones 145-160	Data Bus Addr 11	Data Bus Addr 12	Data Bus Addr 13
		Zones 161-176	Zones 177-192	Zones 193-208								
16	M1XRFTWM A single M1XRFTWM can add up to 144 wireless zones to the M1 Control.	Optional 2 nd M1XRFTWM*	Optional 3 rd M1XRFTWM*	Optional 4 th M1XRFTWM*	M1XIN Hardwired	M1XIN Hardwired	M1XIN Hardwired	M1XIN Hardwired	M1XIN Hardwired	M1XIN Hardwired	M1XIN Hardwired	M1XIN Hardwired
32		**	M1XIN Hardwired	M1XIN Hardwired	M1XIN Hardwired	M1XIN Hardwired	M1XIN Hardwired	M1XIN Hardwired	M1XIN Hardwired	M1XIN Hardwired	M1XIN Hardwired	M1XIN Hardwired
48		**	**	M1XIN Hardwired	M1XIN Hardwired	M1XIN Hardwired	M1XIN Hardwired	M1XIN Hardwired	M1XIN Hardwired	M1XIN Hardwired	M1XIN Hardwired	M1XIN Hardwired
64		**	**	**	M1XIN Hardwired	M1XIN Hardwired	M1XIN Hardwired	M1XIN Hardwired	M1XIN Hardwired	M1XIN Hardwired	M1XIN Hardwired	M1XIN Hardwired
80		**	**	**	**	M1XIN Hardwired	M1XIN Hardwired	M1XIN Hardwired	M1XIN Hardwired	M1XIN Hardwired	M1XIN Hardwired	M1XIN Hardwired
96		**	**	**	**	**	M1XIN Hardwired	M1XIN Hardwired	M1XIN Hardwired	M1XIN Hardwired	M1XIN Hardwired	M1XIN Hardwired
112		**	**	**	**	**	**	M1XIN Hardwired	M1XIN Hardwired	M1XIN Hardwired	M1XIN Hardwired	M1XIN Hardwired
128		**	**	**	**	**	**	**	M1XIN Hardwired	M1XIN Hardwired	M1XIN Hardwired	M1XIN Hardwired
144		**	**	**	**	**	**	**	**	M1XIN Hardwired	M1XIN Hardwired	M1XIN Hardwired

* Indicates address where either a redundant M1XRFTWM Wireless Transceiver OR a M1XIN Hardwired Expander may be installed.

** Indicates an address where no M1XIN (Hardwired Zones) may exist. Based on the left column "Total Wireless Zones Desired" these blocks of 16 zones are **Reserved** for wireless zones only.

One (1) Wireless Transceiver on the M1 Control can handle up to 144 wireless zones as long as wireless sensor is installed within the coverage range of that single transceiver. To cover large buildings, or where construction design decrease wireless performance, up to 3 additional (absolute max. of 4 total) Transceivers may be added to the M1 data bus to increase the coverage range.

IMPORTANT! When installing multiple Transceivers it is important to strategically place them as far away from each other as possible. This is to help insure maximum coverage AND reduce the amount of coverage overlap with each other.

Note: M1XRFTWM Transceivers may ONLY be enrolled at data bus addresses 2, 3, 4, and 5.

Appendix B - Examples of Zone Configurations

Example <u>A</u>			Example <u>B</u>			Example <u>C</u>			
All 208 Zones as Hardwired			144 Wireless Zones plus 16 Hardwired Zones			112 Wireless Zones plus 48 Hardwired Zones			
Zones 1-16	Bus Addr N/A	Inputs on Main Panel	Zones 1-16	Bus Addr N/A	Inputs on Main Panel	Zones 1-16	Bus Addr N/A	Inputs on Main Panel	
Zones 17-32	Bus Addr 2	M1XIN	Zones 17-32	Bus Addr 2	M1XRFTWM	Zones 17-32	Bus Addr 2	M1XRFTWM	
Zones 33-48	Bus Addr 3	M1XIN	Zones 33-48	Bus Addr 3	Optional 2 nd M1XRFTWM	Zones 33-48	Bus Addr 3	Optional 2 nd M1XRFTWM	
Zones 49-64	Bus Addr 4	M1XIN	Zones 49-64	Bus Addr 4	Optional 3rd M1XRFTWM	Zones 49-64	Bus Addr 4	Optional 3rd M1XRFTWM	
Zones 65-80	Bus Addr 5	M1XIN	Zones 65-80	Bus Addr 5	Optional 4th M1XRFTWM	Zones 65-80	Bus Addr 5	Optional 4th M1XRFTWM	
Zones 81-96	Bus Addr 6	M1XIN	Zones 81-96	Bus Addr 6	Absolutely NO M1XIN Expanders on addresses 2 thru 10	Zones 81-96	Bus Addr 6	Absolutely NO M1XIN Expanders on addresses 2 thru 7	
Zones 97-112	Bus Addr 7	M1XIN	Zones 97-112	Bus Addr 7		Zones 97-112	Bus Addr 7		
Zones 113-128	Bus Addr 8	M1XIN	Zones 113-128	Bus Addr 8		Zones 113-128	Bus Addr 8		
Zones 129-144	Bus Addr 9	M1XIN	Zones 129-144	Bus Addr 9		Zones 129-144	Bus Addr 9		M1XIN
Zones 145-160	Bus Addr 10	M1XIN	Zones 145-160	Bus Addr 10		Zones 145-160	Bus Addr 10		M1XIN
Zones 161-176	Bus Addr 11	M1XIN	Zones 161-176	Bus Addr 11	M1XIN	Zones 161-176	Bus Addr 11	M1XIN	
Zones 177-192	Bus Addr 12	M1XIN	Zones 177-192	Bus Addr 12	M1XIN	Zones 177-192	Bus Addr 12	M1XIN	
Zones 193-208	Bus Addr 13	M1XIN or Keypad Zones	Zones 193-208	Bus Addr 13	M1XIN or Keypad Zones	Zones 193-208	Bus Addr 13	M1XIN or Keypad Zones	
N/A	Bus Addr 14	N/A	N/A	Bus Addr 14	N/A	N/A	Bus Addr 14	N/A	
N/A	Bus Addr 15	N/A	N/A	Bus Addr 15	N/A	N/A	Bus Addr 15	N/A	

Maximum of 144 Wireless Zones

Maximum of 112 Wireless Zones

Appendix C - Installing Multiple Redundant Transceivers

After the first Transceiver has been installed at address 2, up to 3 additional units may be installed for redundancy or improved coverage and range. Each additional unit will require its own data bus address and must be enrolled into the control.

IMPORTANT: There should NEVER be more than 4 total ELK-M1XRFTWM Transceivers connected to the M1 Control. Special attention must be made to minimize excessive coverage overlap. † The use of multiple redundant Transceivers was not evaluated by UL.

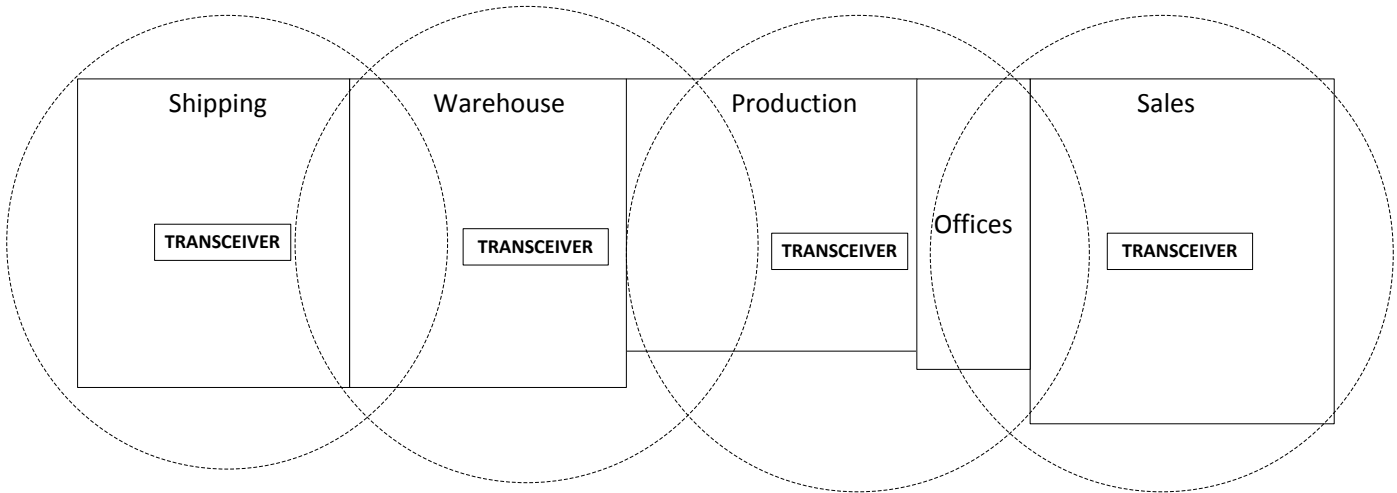

EXAMPLE OF LARGE COMMERCIAL BUILDING with the maximum of 4 ELK Transceivers

Appendix D - Agency Statements

FCC AND IC COMPLIANCE STATEMENT:

THIS DEVICE COMPLIES WITH PART 15 OF THE FCC RULES. OPERATION IS SUBJECT TO THE FOLLOWING TWO CONDITIONS: (1) THIS DEVICE MAY NOT CAUSE HARMFUL INTERFERENCE, AND (2) THIS DEVICE MUST ACCEPT ANY INTERFERENCE RECEIVED, INCLUDING INTERFERENCE THAT MAY CAUSE UNDESIRE OPERATION.

NOTE: THE GRANTEE IS NOT RESPONSIBLE FOR ANY CHANGES OR MODIFICATIONS NOT EXPRESSLY APPROVED BY THE PARTY RESPONSIBLE FOR COMPLIANCE. SUCH MODIFICATIONS COULD VOID THE USER'S AUTHORITY TO OPERATE THE EQUIPMENT.

NOTE: This equipment has been tested and found to comply with the limits for a Class B digital device, pursuant to part 15 of the FCC Rules. These limits are designed to provide reasonable protection against harmful interference in a residential installation. This equipment generates uses and can radiate radio frequency energy and, if not installed and used in accordance with the instructions, may cause harmful interference to radio communications. However, there is no guarantee that interference will not occur in a particular installation. If this equipment does cause harmful interference to radio or television reception, which can be determined by turning the equipment off and on, the user is encouraged to try to correct the interference by one or more of the following measures:

- Reorient or relocate the receiving antenna.
- Increase the separation between the equipment and receiver.
- Connect the equipment into an outlet on a circuit different from that to which the receiver is connected.
- Consult the dealer or an experienced radio/TV technician for help.

This device complies with Industry Canada license-exempt RSS standard(s). Operation is subject to the following two conditions: (1) this device may not cause interference, and (2) this device must accept any interference, including interference that may cause undesired operation of the device.

Le présent appareil est conforme aux CNR d'Industrie Canada applicables aux appareils radio exempts de licence. L'exploitation est autorisée aux deux conditions suivantes : (1) l'appareil ne doit pas produire de brouillage, et (2) l'utilisateur de l'appareil doit accepter tout brouillage radioélectrique subi, même si le brouillage est susceptible d'en compromettre le fonctionnement.

ELK-M1XRFTWM M1 Two-Way Receiver FCC ID: TMA ELK-M1XRFTWM IC: 4353A-M1XRFTWM

This equipment complies with the FCC RF radiation exposure limits set forth for an uncontrolled environment. This equipment should be installed and operated with a minimum distance of 20cm between the radiator and any part of your body.

This device must not be collocated or operating in conjunction with any other antenna or transmitter.

Limited Warranty

The ELK-M1XRFTWM Wireless Transceiver is warranted to be free from defects and workmanship for a period of 2 years from date of manufacture. Batteries used with wireless devices are not warranted. Elk makes no warranty, express or implied, including that of merchantability or fitness for any particular purpose with regard to batteries used with wireless devices. Refer to Elk's website for full warranty statement and details.

