

# Fiber Optics Redefined

*Questions and Answers on the  
basics of fiber optic  
installation*

[cleerlinefiber.com](http://cleerlinefiber.com)



# Questions and Answers

**Q: What are the two main types of fiber?**

**A:** The two main types of fiber glass are single mode and multimode.

- Single mode fiber has a small light-carrying core of 8 to 10 microns in diameter. It is normally used for long distance transmissions with laser diode-based fiber optic transmission equipment.

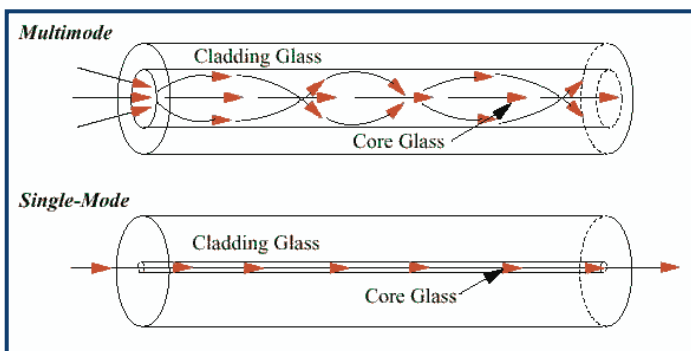

- Multimode fiber has a relatively large light-carrying core, usually 50 microns or larger in diameter. It is usually used for short distance transmissions with LED or laser-based fiber optic equipment

**Q: I see there are four different types of multimode fiber. How do I know which is right for my project?**

**A:** OM1 is traditionally an older technology that is rarely supported in today's applications. Some older OM2 was even designed for LED-based transmission. Today's laser-optimized OM2, OM3, and OM4 are the preferred fibers when using multimode.

- OM1: fiber with 200/500 MHz\*km overfilled launch (OFL) bandwidth at 850/1300nm (typically 62.5/125um fiber).
- OM2: laser-optimized with 400/500 MHz\*km OFL bandwidth at 850/1300nm (typically 50/125um fiber).

- OM3: laser-optimized 50um fiber having 2000 MHz\*km EMB bandwidth designed for 10 Gb/s, 40 Gb/s, and 100 Gb/s transmission.
- OM4: laser-optimized 50um fiber having 4700 MHz\*km EMB bandwidth designed for 10 Gb/s, 40 Gb/s, and 100 Gb/s transmission.

FIBER TYPES AND REACH			
Fiber Type	Bandwidth* Length Product (MHz*km or GHz*m)	10GBASE-SR Distance (meters)	40GBASE-SR4 and 100GBASE-SR10 Distance (meters)
OM1	160-200	33	N/A
OM2	400-500	82	N/A
OM3	2000	300	100
OM4	4700	400	150

**Q: Why do I need to run more than one strand of fiber?**

**A:** Many fiber optic products are media converters: they essentially change electric 1's and 0's to light 1's and 0's and back again. Additional fiber strands provide electronics more "lanes" for traffic.

As an example, HDMI is (basically) comprised of four signals or lanes: TMDS 0, TMDS 1, TMDS 2, and TMDS Clock. With HDMI 2.0a (18Gbps) this bandwidth is split into the four signals. TMDS 0-2 are each around 6Gbps, and TMDS clock is a low bandwidth signal (we also combine this with IR, RS232, and a few other signals).

For a 4-fiber optic solution, each of these lanes can be put on a separate fiber optic strand with

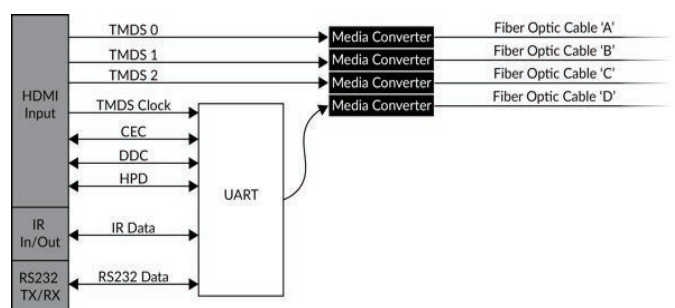

no bandwidth issues and no need to multiplex. When you reduce the cabling to two fiber optic strands, you need to multiplex two lanes together for each strand. The multiplexer has to send the two lanes as separate beams of light modulating at different frequencies on the same cable. A filter network at the receiver pulls each signal back out.

When you reduce the cabling to one fiber optic strand, you need to multiplex four lanes together, then filter back out on the receiver end.

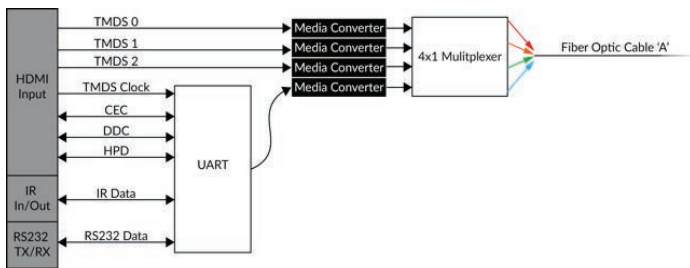

**Q: Which cable construction should I use: Duplex, Micro-Distribution, or Breakout?**

A: There is not a single answer that is 100% correct! Cost of product vs cost of labor is frequently a major factor. Below you will find a comparison of running four strands of fiber using the three most prominent cable constructions:

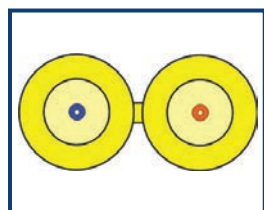

**Cable Constructions:**  
Duplex: (2) 3.0mm tubes side by side each with a single strand of fiber.

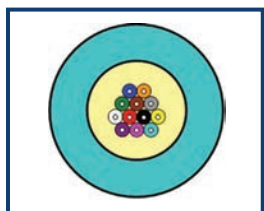

Micro-Distribution:  
(1) 3.0mm tube with (4) 250um fibers



Breakout: (1) 7.2mm Jacket with (4) 2.0mm inner tubes, each with a single strand of fiber.

Example: We will use a cable length of 125ft, labor rate of \$80/hr, terminating with SC connectors in a 4-port keystone plate.

**Duplex:**

- 2 separate duplex cables: (OM3 plenum rated)
- Cable: \$0.47ft per cable (qty. required: 2); total cost of fiber: 125ft x \$0.47 x (2) = \$117.50
- Labor: (pulling cable) 30 minutes = \$40.00
- Connectors: (4ea) SSF-SC connectors \$7.90ea = \$31.60
- Labor: (termination) 30 minutes = \$40.00

Total duplex option terminated = \$229.10

**4 Strand Micro-Distribution:**

- 1ea 4 strand cable: (OM3 plenum rated)
- Cable: \$0.65ft per cable (qty. required: 1); total cost of fiber: 125ft x \$0.65 = \$81.25
- Labor: (pulling cable) 30 minutes = \$40.00
- Connectors: (4ea) SSF-SC connectors \$7.90ea = \$31.60
- Labor: (termination) 40 minutes = \$53.20

Total micro-distribution option terminated = \$206.05

**4 Strand Breakout:**

- 1ea 4 strand breakout cable: (OM3 plenum rated)
- Cable: \$1.28ft per cable (qty. required 1); total cost of fiber: 125ft x \$1.28 = \$160.00
- Labor: (pulling cable) 30 minutes = \$40.00
- Connectors: (4ea) SSF-SC connectors \$7.90ea = \$31.60
- Labor: (termination) 40 minutes = \$53.20

Total breakout option terminated = \$284.80

**Q: Do I need to use a fan-out kit (900um) or breakout kit (3mm) to build up the 250um fibers when using Micro-Distribution cables?**

A: This is another question with more than one answer. Traditional fibers do not incorporate the strength found in SSF™ fibers. Therefore, it is highly recommended to use a fan-out kit or breakout kit with traditional fibers. As SSF™

fibers have a much higher tolerance due to their polymer coating, it becomes a question of your comfort in leaving 250um fibers exposed.

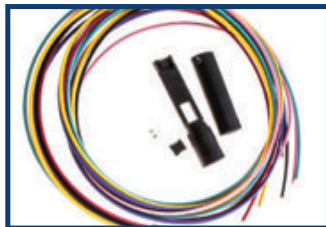
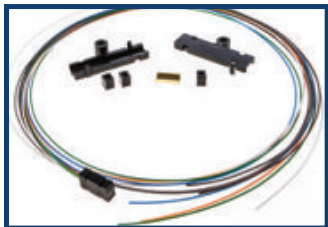

**Applications:**



**Terminating Fiber to a Wall Plate**

Completely up to you. If you terminate the fibers on the 250um soft peel coating and plug into a keystone, you should have no issues with fiber left behind in the wall. If you are uncomfortable or think additional wires may be pulled in the wall behind the plate, install either a 900um or 3mm kit.



**Terminating Fiber through a Cable Pass-Through Plate**

We would highly recommend putting either a 900um or 3mm kit on the cable. The cable will be exposed and typically directly connected to a device.



**Terminating Fiber in an Equipment Rack**

We would highly recommend putting either a 900um or 3mm kit on the cable. The cable will be exposed and typically directly connected to a device.



**Terminating in a Fiber Tray in Equipment Rack**

Most fiber trays are enclosed and do not allow for access to the 250um fibers after they are terminated. Therefore, a 900um or 3mm kit is not required.

**Terminating Fiber in Surface Mount Can/Enclosure**

Most fiber trays are enclosed and do not allow for access to the 250um fibers after they are terminated. Therefore, a 900um or 3mm kit is not required. If you are using a generic wall enclosure or the fiber is easily accessible by others, we would recommend using a 900um or 3mm kit.



**Q: Is there more than one style of fiber connector?**

A: There are quite a few different styles of connectors. In the audio/video industry, the three most popular styles are SC, LC, and ST.



SC: A 2.5mm snap-in connector widely used in single mode systems for its excellent performance and in multimode systems because it was the first connector chosen as the standard for TIA-568. It is a snap-in connector that latches with a simple push-pull motion. It is also available in a duplex configuration.



LC: A Lucent connector uses a 1.25mm ferrule, half the size of the ST and SC. Otherwise, it is a standard ceramic ferrule connector, favored for single mode. It is also the connector of choice for multimode transceivers gigabit speeds and above.



ST: A 2.5mm AT&T™-designed connector for single mode and multimode networks. It has a bayonet mount and a long cylindrical ferrule to hold the fiber. Most ferrules are ceramic, but some are metal or plastic

**Q: How do I know which style (SC, LC, ST) of connector to install?**

A: This is tricky, and there really is not a single answer. Connector style is determined by the equipment that the fiber cable will be plugged into. Many people will standardize on SC connectors due to their lower cost and ease of use. If you know what equipment you will be using, you will be able to determine which style of connector to install up front.

**Q: Are connectors specific to the brand of fiber?**

A: No. Connectors are available from many manufacturers. They are designed specifically for the type of fiber you are using. Single mode uses a 9/125 connector, and multimode utilizes a 62.5/125 (older technology) or 50/125 connector.

**Q: Is there only one way to install a connector on fiber optic cables?**

A: There are actually multiple types of connection methods for fiber optic cables. The most common for inside premise and in the audio/video world are mechanical splice connectors.

- Mechanical Splice: Connectors with a short stub of fiber already epoxied into the ferrule and polished,

along with a mechanical splice in the back of the connector. Simply cleave a fiber and insert it like a splice. This process can be completed very quickly.

- “Hot Melt” Adhesive/Polish: This is a 3M™ trade name for a connector that already has the epoxy (actually a heat set glue) inside the connector. Insert the connector in a special oven. The glue quickly melts, allowing you to remove the connector and insert the stripped fiber. Let it cool, and it is ready to polish
- Anaerobic Adhesive/Polish: These connectors use a quick setting “anaerobic” adhesive to replace the epoxy or Hot Melt adhesive. Anaerobic adhesive cures faster than other types of adhesives.
- Crimp/Epoxy/Polish: Fiber is affixed into the connector using epoxy or by mechanically crimping. The end is polished with special polishing film by hand or with a mechanical tool.
- Fusion: Fusion splicing is widely used as it provide sthe lowest loss and least reflectance, as well as providing the strongest and most reliable joint.

**Q: What if I terminate my fiber cable with the wrong style connector for the equipment?**

A: Not a problem! For example, if you have a SC-style connector installed and find that you need LC instead, you can purchase a SC-SC coupler, then purchase a pre-terminated patch cable with SC on one end and LC on the other. This is a very common solution. Patch Cables can be purchased with all various configurations (SC-SC, SC-LC, SC-ST, etc).



## Recommended Locations to Run Fiber Optic Cable in a Residence

### 1. Equipment to Displays / Projectors

- Minimum: 2 Strands Multimode 50/125
- Preferred: 4 Strands Multimode 50/125

### 2. Network Switches to Network Switches

- Minimum: 2 Strands Multimode 50/125
- Preferred: 6–12 Strands Multimode 50/125

### 3. Network Switches to Access Points

- Minimum: 1 Strand Multimode 50/125
- Preferred: 2 Strands Multimode 50/125

### 4. AV Racks to AV Racks

- Minimum: 2 Strands Multimode 50/125
- Preferred: 6–12 Strands Multimode 50/125

### 5. DVR/NVR to Security Cameras

- Minimum: 1 Strand Multimode 50/125
- Preferred: 2–4 Strands Multimode 50/125

### 6. Satellite Dish LNB to Multi-switch

- Minimum: 2 Strands Single Mode 9/125
- Preferred: 2 Strands Single Mode 9/125 + Empty Conduit

### 7. Service Demarc to Main Structured Cable Distribution

- Minimum: 2 Strands Single Mode 9/125 + Empty Conduit

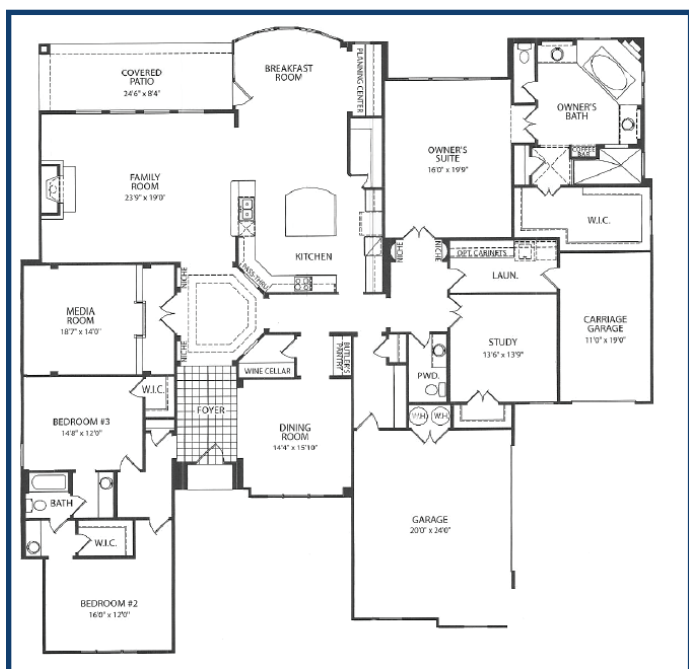

## Q: Why use SSF™ fiber?

A: SSF™ fiber is Stronger, Safer, and Faster terminating than any other product on the market.

**Stronger:** 10,000 times the bend longevity and up to 200 times the pull over standard fiber allows installers to treat our product like standard Category cable with no fear of failure.

**Safer:** The fiber, with its smaller glass cladding layer, is more bendable and forgiving. The 125um coated GGP will not puncture the skin.

**Faster:** SSF™ is faster to terminate by skilled technicians since less preparation and fewer precautions are necessary. It is also faster to train new technicians. We have even trained customers over the phone while they were out on a job site!

## Q: Is SSF™ fiber glass or plastic?

A: SSF™ is referred to as GGP construction. There is a traditional glass core. The cladding consists of traditional glass cladding with a layer of polymer on the outside of the cladding.

## Q: Are SSF™ connectors reusable?

A: Yes, SSF™ connectors are reusable up to 5 times.

## Q: What tools are required for SSF™ connectors?

A: To properly terminate SSF™ connectors you will need the following tools:





Fiber Optic Cleaver: A cleave in an optical fiber is a deliberate, controlled break, intended to create a perfectly flat end face perpendicular to the longitudinal axis of the fiber.



VFL (Visual Fault Locator): The visual fault locator can find breaks in fibers or high losses around connectors in simplex cables. The light that escapes at a break, for example, will be visible through the jacket of the cable.



Fiber Strippers: Fiber strippers are used to remove cable jackets at 3.0mm, 2.0mm, and 900um.



Kevlar Shears: Kevlar shears allow cutting of the Aramid yarns (Kevlar®), the strength member within the cable.

### Q: What do I need to test the fibers?

A: A variety of testing equipment is available for fiber optics. A simple VFL (Visual Fault Locator) will at least allow you to verify that light is passing through the entire cable and connectors. While this will work in many situations, we recommend using a dB Loss meter. A dB Loss Meter will give you the ability to check and verify the actual total loss of the terminated cable with connectors. There are many versions of testers available in the market.



### Q: What is the difference between SSF™ and traditional fiber?

A: SSF™ fiber is a GGP (Glass, Glass, Polymer) design that enables up to 200 times the life expectancy under stress.

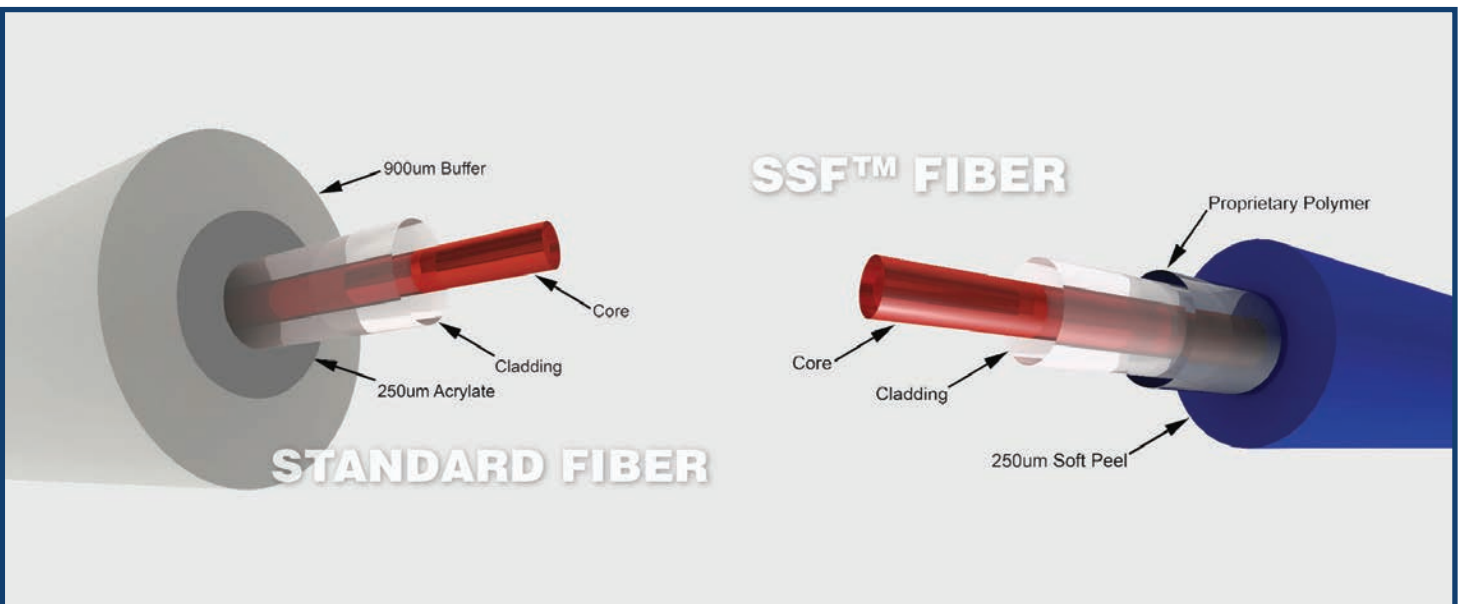

# THE FINE LINE OF 4k TRANSMISSION

Old, Current or Future	Resolution	Frame Rate (FPS)	Compression	Deep Color Bit Depth	HDR	Wide Color Gamut (BT2020)	HDMI Version	Data Rate
OLD	1920x1080	24	4:2:0	8 BIT	NO	NO	1.4	2.23 GBPS
OLD	1920x1080	60	4:2:0	8 BIT	NO	NO	1.4	4.45 GBPS
OLD	1920x1080	60	4:4:4	8 BIT	NO	NO	1.4	4.45 GBPS
OLD	3840x2160	24	4:2:0	8 BIT	NO	NO	1.4	8.91 GBPS
OLD	3840x2160	24	4:4:4	8 BIT	NO	NO	1.4	8.91 GBPS
OLD	4096x2160	24	4:4:4	8 BIT	NO	NO	1.4	8.91 GBPS
OLD	3840x2106	60	4:2:0	8 BIT	NO	NO	1.4/2.0	8.91 GBPS

**COPPER CABLING IS AT OR NEAR ITS LIMITS AND NOT CAPABLE OF MEETING THE IP AND HD VIDEO REQUIREMENTS OF THE FUTURE.**

CURRENT	3840x2160	24	4:2:2	10 BIT	YES	YES	2.0(a/b)	8.91 GBPS
CURRENT	3840x2160	24	4:4:4	10 BIT	YES	YES	2.0(a/b)	11.14 GBPS
CURRENT	3840x2160	60	4:2:0	10 BIT	YES	YES	2.0(a/b)	11.14 GBPS
CURRENT	3840x2160	24	4:4:4	12 BIT	YES	YES	2.0(a/b)	13.37 GBPS
CURRENT	3840x2160	60	4:2:0	12 BIT	OPTIONAL	YES	2.0(a/b)	13.37 GBPS
CURRENT	3840x2160	60	4:2:2	12 BIT	OPTIONAL	YES	2.0(a/b)	17.82 GBPS
CURRENT	3840x2160	60	4:4:4	8 BIT	OPTIONAL	YES	2.0(a/b)	17.82 GBPS

**THESE FORMATS ARE ALL IN USE TODAY.**

Graphic courtesy of Murideo © AVPro Global Holdings 2016