

RadioRA 3 Processors

RadioRA 3 processors allow for setup, control, and monitoring of RadioRA devices and Lutron wireless shades from a smartphone or tablet using the Lutron App¹.

RadioRA 3 processors also enable compatible Lutron control systems to communicate with up to 99 Clear Connect – Type X devices per processor (100 devices total) and 99 Clear Connect – Type A devices per processor (100 devices total).

Features

- Programmed via the Lutron Designer PC tool² and Lutron App¹.
- Scene control via the Lutron App, Pico, Sunnata, and seeTouch scene keypads.
- Timeclock scheduling of daily events.
- Powered by an IEEE 802.3af, IEEE 802.3at or IEEE 802.3bt compliant Power over Ethernet (PoE) switch or injector.
- Connects to the Wi-Fi router via an Ethernet connection.
- Local device operation will continue to function if internet connection is lost.
- System access from anywhere in the world using the Lutron App¹.
- Control outside the app via widgets (iOS® and Android™).
- Supports Geofencing from the Lutron App¹.
- Control from *Apple Watch*.
- Supports integration with other smart home brands including Amazon® Alexa®, Apple HomeKit®, Google® Assistant, Sonos®, Ring®, and more.
- Up to four (4) wireless repeaters can be added to extend the range for Clear Connect – Type A devices (Maestro, etc.) for larger systems. The wireless repeater does not extend the range of Clear Connect – Type X devices (Sunnata, etc.).
- Integration with professional A/V and security systems via Lutron's LEAP API.

Compatible Devices³

- Sunnata dimmers, switches, and keypads for RadioRA 3 system
- seeTouch keypads for RadioRA 2 system
- Maestro dimmers, switches, and fan controls for RadioRA 2 system
- Plug-in dimmers, tabletop lamp dimmers, and appliance modules for RadioRA 2 system
- Sivoia QS Triathlon and Sivoia QS wireless roller shades, drapery track, Kirbé, and Roman shade systems
- Pico wireless remotes and keypads
- Radio Powr Savr occupancy/vacancy sensors
- RF dimming modules (0–10 V control, relay module, CCO)
- Visor control receiver for RadioRA 2 system (coming soon)
- Auxiliary/wireless repeaters (up to 4) for RadioRA 2 and RA2 Select systems

¹ The Lutron App is required for setup and use with the RadioRA 3 process. The Lutron App is compatible with iOS® devices version 8.0 or later and Android™ devices 4.1 or later.

² The PC tool requires a 32 or 64 bit processor running Windows® 10, with a recommended minimum of 8 GB of RAM, 4 GB disk space, and a 2.67 GHz Core i5 processor.

³ RadioRA 2 GRAFIK T, Wallbox Power Modules (WPM), GRAFIK Eye, seeTemp, HVAC controller, and wireless temperature sensors are not compatible with RadioRA 3.



Processor



Processor in shelf-mount adapter

Model Number	Description
RR-PROC3-KIT	Includes shelf-mount adapter, PoE injector and 6 ft (1.8 m) Ethernet cable
RR-PROC3-CW	Includes recess-mount adapter and junction box mount adapter

RadioRA 3 Processors

Specifications

Regulatory Approvals

- cULus Listed
- FCC approved. Complies with the limits of a Class B digital device, pursuant to Part 15 of the FCC rules
- IC certified
- NOM certified
- IFETEL certified

PoE Power

- L-POEI-BL (included in RR-PROC3-KIT, available for purchase separately) - fully compliant with IEEE802.3af (max. 15.4 W)
- Processor must be powered by PoE supply that is IEEE 802.3af, IEEE 802.3at or IEEE 802.3bt compliant.
- Processor is classified as Class 1 typical 1.5 W (max. 4.0 W) IEEE 802.3af device.

Environment

- Ambient operating temperature: 32 °F to 104 °F (0 °C to 40 °C)
- 0% to 90% humidity, non-condensing
- Indoor use only

Communications

- seeTouch keypads, Maestro dimmers, Pico wireless controls, Sivoia QS wireless shades, etc. (Clear Connect – Type A):
 - Each device must be within 30 ft (9 m) of a repeater or wireless processor.
 - Repeaters can be spanned up to 60 ft (18 m) apart from other repeaters to create the network.
 - Utilizes 434 MHz RF (North America)
- Sunnata dimmers, switches, keypads, etc. (Clear Connect – Type X):
 - All devices associated with the wireless processor must be within a 75 ft (23 m) radius of the processor.
 - There must be a minimum of two devices within 25 ft (7.6 m) of the wireless processor.
 - Each Clear Connect – Type X device should have two or more non-battery powered Type X devices within 25 ft (7.6 m) of another compatible Clear Connect – Type X device. Using more than two devices is ideal for creating an ultra high-performance mesh network.
 - Utilizes 2.4 GHz RF
- Internet connection required for initial setup and to receive periodic firmware updates.
- For more information, please refer to the Wireless Setup Guide which can be found in the RA3 Support Center: www.lutron.com/RA3support

Protection

- Tested to withstand electrostatic discharge without damage or memory loss in accordance with IEC 61000-4-2
- Tested to withstand surge voltages without damage or loss of operation, in accordance with IEEE C62.41-1991

Power Failure Memory

- Should power be interrupted, the RA3 processor will return to its previous state when power is restored.
- Timeclock will be retained via internal battery backup.

Connections

- RadioRA 3 processor requires an Ethernet connection for data and power via Power over Ethernet (PoE).
- RR-PROC3-KIT includes a 6 ft (1.8 m) down-angle Ethernet cable for connection to the processor mounted in the shelf-mount adapter and 3 ft (1 m) Ethernet cable for connection to WiFi router.

Mounting

- Reliability of Clear Connect wireless communication requires that the wireless processor be centrally-located and within a maximum distance of the specific wireless devices in the system. Wireless processors must be mounted 5 ft (1.5 m) away from wireless interference sources like microwaves, Wireless Access Points (WAPs), etc.
- PoE wiring must be kept internal to the building. Do not run PoE wiring outdoors or install the processor in metallic enclosures.
- Maximum supported Ethernet cable length is 328 ft (100 m)
- For myLutron users, please see Application Note #745 (P/N 048745) for additional information on Clear Connect – Type X Best Practices on www.lutron.com

Replacement Parts

Model Number	Description
L-CMNT-WH	Recess-mount adapter
L-JMNT-WH	Junction box mount adapter
L-SMNT-WH*	Shelf-mount adapter
L-POEI-BL	PoE injector with U.S. clip, 6 ft (1.8 m) down-angle 3 ft (1 m) Ethernet cable

* Needs down-angle Ethernet cable similar to the one included in the RR-PROC3-KIT or L-POEI-BL.

RadioRA 3 Processors

RadioRA 3 System Security Statement

Lutron takes cybersecurity very seriously. We actively monitor the threat landscape and take a proactive approach to security and privacy, continuously working to update and enhance our systems and processes.

At Lutron, we call our approach to cybersecurity **“Secure Lifecycle”**, and we would like to present the following steps we take to protect your security and privacy:

- **Security by Design.** When building a new system, Lutron utilizes a dedicated security team to ensure best practices are implemented. Security is built in. It is not an afterthought or an add-on.
- **Third-Party Validation.** Security is complicated. Lutron has a dedicated team of internal experts, but we also leverage external experts to double-check our work and to make security recommendations.
- **Continuous Monitoring and Improvements.** Security is a constantly moving target. Lutron uses a dedicated security team to continuously monitor for potential threats and, when needed, send out security patches to update installed systems.
- **Ongoing Support.** Lutron has the resources you need to answer questions about security when they arise.

We incorporate a variety of security features into our product designs. These features include recommendations from the National Institute of Standards and Technology (NIST) among others, and they are aimed at meeting our secure lifecycle protections. While we do not publish a comprehensive list of our security features, the following list is a small example of some of the techniques employed in our system designs for the RadioRA 3 processor, associated devices and associated services (such as mobile applications and cloud resources):

1. Secure and authenticated remote access with unique keys for every RadioRA 3 system.
2. A secure hardware element (“chip”) on the RadioRA 3 processor to guard the keys used for secure communication and authentication.
3. Enforcing industry-standard encrypted communication and techniques for our integration protocols to the highest extent possible. Any integrated third-party components or systems should be evaluated independently.
4. Secure commissioning – all communication between the system programming software tool/app and the processors is encrypted and authenticated. Programming a system requires permission to access that system.
5. Security updates are pushed out automatically to the lighting system for urgent security patches. Lutron is committed to one year of security support from system start-up date.
6. Use of industry-standard techniques for cloud-based integrations, such as OAuth2.0
7. Signed processor firmware to ensure a firmware update is authentically from Lutron.

If you have additional questions or would like to make a vulnerability disclosure to Lutron, please contact Lutron’s 24/7 Technical Support Line at 1.844.LUTRON1 or email us at support@lutron.com

RadioRA 3 Processors

Dimensions

Front View

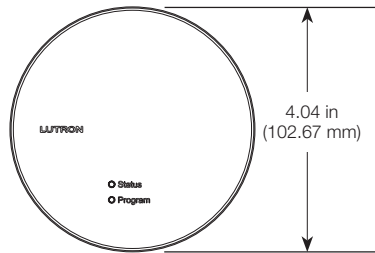

Bottom View

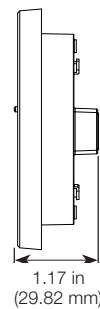

Back View

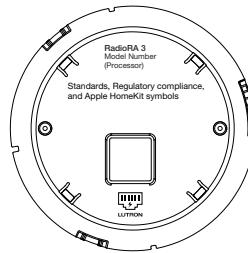

PoE Injector

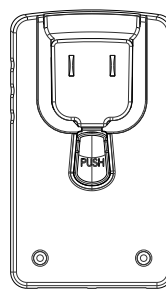
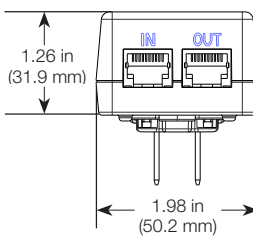
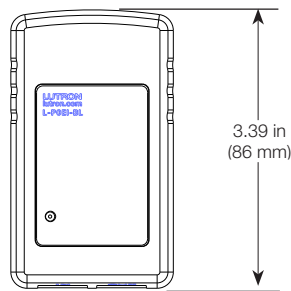

Shelf-mount Adapter

Front View

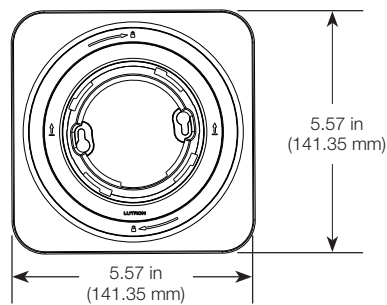

Side View

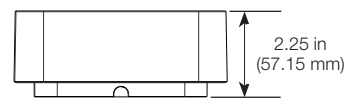

Detail View

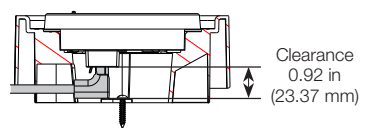

Recess-mount Adapter

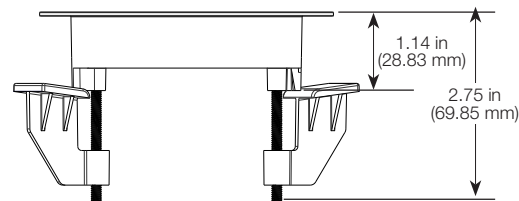
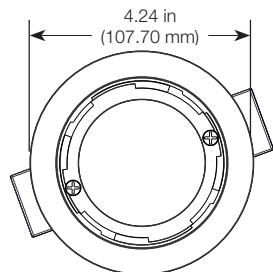

Junction Box Mount Adapter

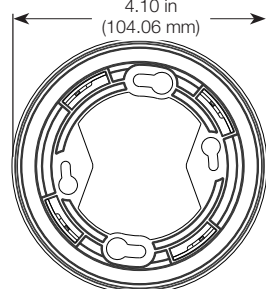

RadioRA 3 Processors

Mounting

Included in RR-PROC3-KIT

Shelf-mount adapter
P/N: L-SMNT-WH

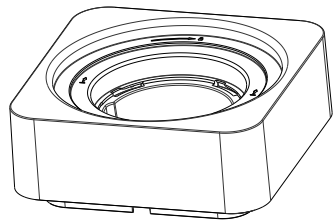

PoE injector and region-specific plugs
P/N: L-POEI-BL

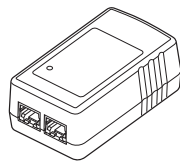

3 ft (1 m)
Ethernet cable

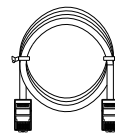

6 ft (1.8 m)
Ethernet cable

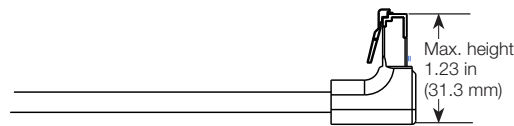
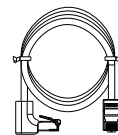

Note: The low-profile of the shelf mount adapter requires a down-angle connector with a maximum height of 1.23 in (31.3 mm). See down-angle cable included in RR-PROC3-KIT or L-POEI-BL.

Included in RR-PROC3-CW

Recess-mount adapter
P/N: L-CMNT-WH

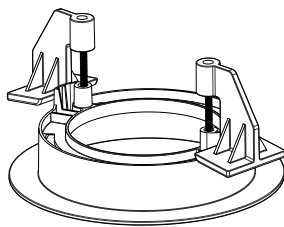

Junction box mount adapter
P/N: L-JMNT-WH

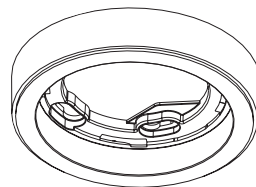

Please see the install guide for RadioRA 3 processors on www.lutron.com for detailed installation instructions for all mounting types.

Lutron, Clear Connect, GRAFIK T, GRAFIK Eye, Kirbé, Maestro, Pico, RA2 Select, Radio Powr Savr, RadioRA, RadioRA 2, RadioRA 3, Sunnata, seeTouch, seeTemp, Sivoia, and Triathlon are trademarks or registered trademarks of Lutron Electronics Co., Inc. in the US and/or other countries.

Apple Watch is a trademark of Apple Inc. registered in the U.S. and other countries.
All other product names, logos, and brands are property of their respective owners.