

IQ KEYPAD

INSTALLATION MANUAL

IQ Keypad-PG
IQ Keypad Prox-PG
SW Ver 1.0

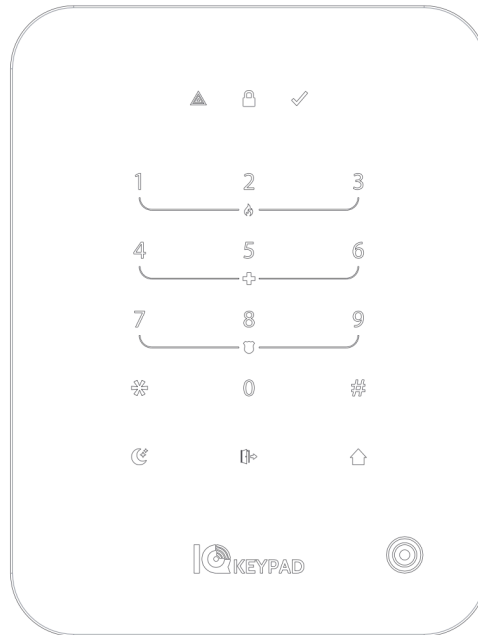

IQ Keypad is a battery powered, capacitive touch keypad for use with compatible IQ4 NS, IQ4 Hub, IQ Panel 4 & IQ Pro platforms via the PowerG protocol. It provides an easy and intuitive interface to control basic features of the system.

This manual covers both IQ Keypad-PG and IQ Keypad Prox-PG models.

INCLUDED IN BOX

IQ Keypad

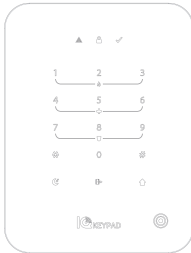

4 x AA
Batteries

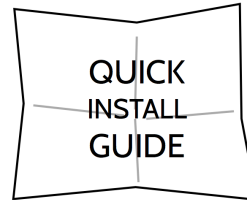
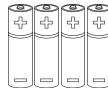

SUPPORT



QUESTIONS?

Contact us at
intrusion-support@jci.com

ABOUT THIS GUIDE

This document outlines the basic hardware specifications and software directions to install and customize the IQ Keypad. Note that the information presented is not comprehensive, but is specifically dedicated to those menus, features, and systems accessible solely to those with the proper installation code. Features accessible to users and installers alike are outlined in the IQ Keypad User Guide. The information contained is confidential and proprietary, and is solely owned by Qolsys Inc. Any reproduction, modification or distribution without permission is strictly prohibited. Reference to IQ Keypad throughout this manual covers both models IQ Keypad-PG and IQ Keypad Prox-PG unless stated differently.

IQ KEYPAD OVERVIEW

Warning: This Product should be installed in accordance with the National Fire Alarm Code, ANSI/NFPA 72, (National Fire Protection Association, Batterymarch Park, Quincy, MA 02269) and with National Electric Code, ANSI/NFPA 70. Printed information describing proper installation, operation, testing, maintenance, evacuation planning, and repair service is to be provided with this Product. In Canada the product shall be installed in accordance with the Standard for the Installation of Residential Fire Warning Systems, CAN/ULC-S540.

Warning: For Canadian installations this Product and all sensors associated with it (collectively, the “System”) should be tested once a week. The test shall be performed also with primary DC power de-energized. For recommended smoke detectors maintenance instructions refer to user manual associated with compatible Qolsys model QS5110-P840 smoke detector.

EXTERIOR FRONT

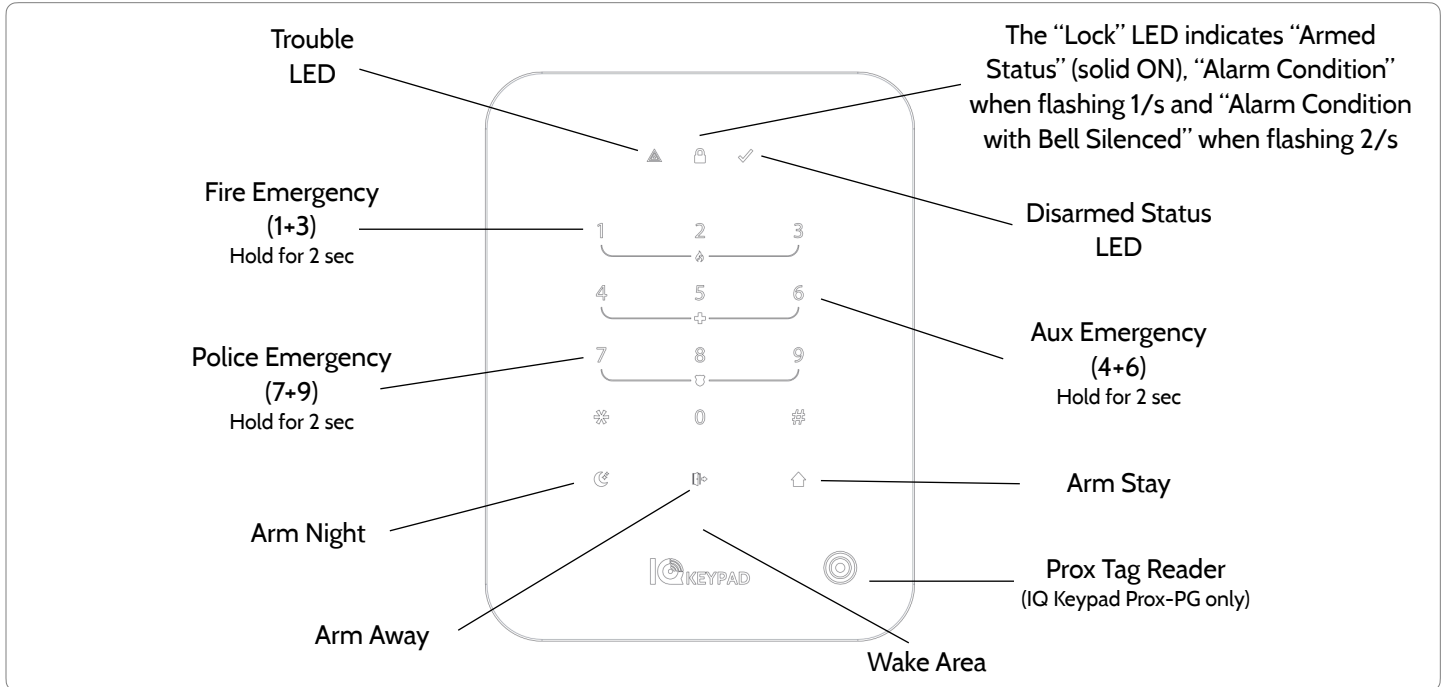

EXTERIOR BACK

For UL2610, ULC-S304
Security Levels II and
above and EN50131
Grade 2 applications this
screw shall be used for
tamper protection against
mounting removal

Mounting
Holes

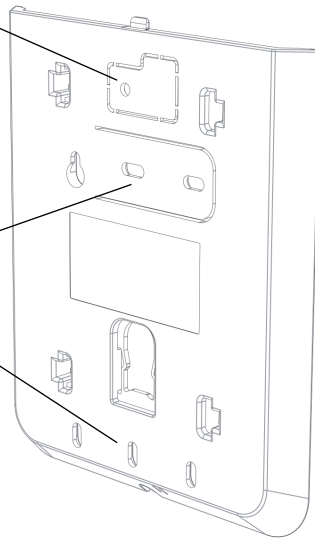

4 x AA Batteries
behind Back Plate

Retaining Screw

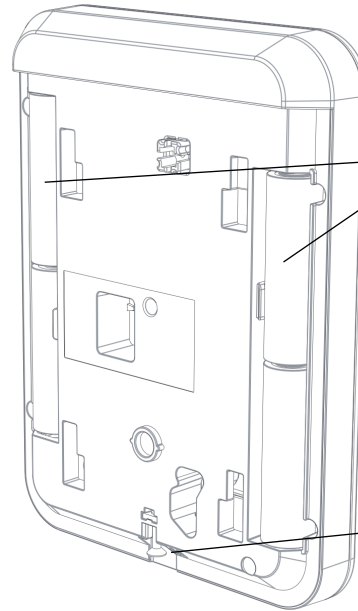

INSTALLING IQ KEYPAD

INSTALLING THE IQ KEYPAD

WALL MOUNT

Note: For UL/ULC Commercial Burg installations (UL2610/ULC-S304 Security Level II compliant) and EN50131 Grade 2 use only wall mount option. This product when installed as per these instructions does not present the risk of fire, electric shock, or injury to persons.

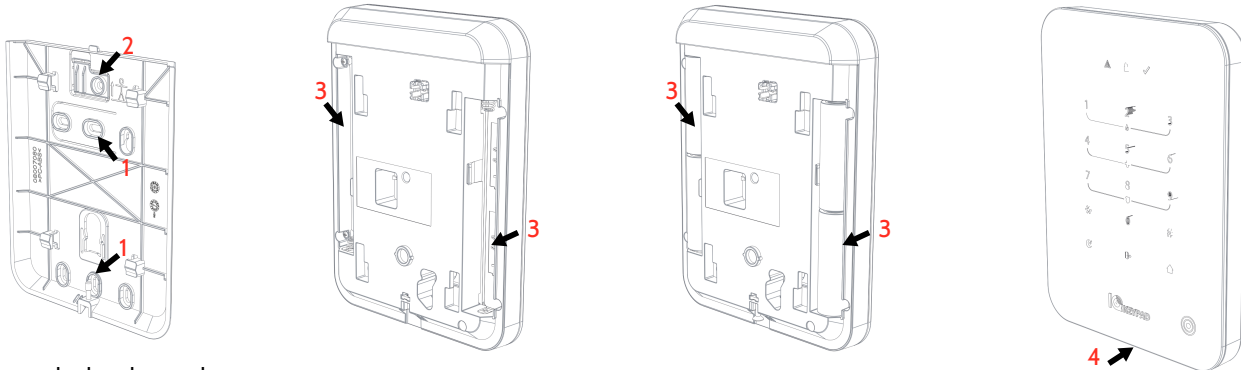

1. Mount the bracket to the wall using appropriate hardware ensuring it is level.

2. A screw shall be used in this hole for UL2610, ULC-S304 Security Levels II and above and EN50131 Grade 2 installations.

3. Insert the 4 x AA batteries in to the battery slots.

Be sure to observe correct polarity.

Use only Energizer AA 1.5V ALKALINE BATTERY

4. Slide the keypad down onto the wall mount and secure with the bottom screw so that it can not be removed.

ENROLLING THE IQ KEYPAD

The IQ Keypad can be paired to either an IQ4 NS, IQ4 Hub, IQ Panel 4 (4.5.0) or IQ Pro (4.4.0) using the PowerG protocol. Panels that do not have the PowerG daughter card installed will not support the IQ Keypad. Follow the instructions below to pair an IQ Keypad to the primary panel:

1. On the primary panel, start the “Auto Learn” process as indicated in the primary panel manual (Settings/Advanced Settings/Installation/Devices/Security Sensors/Auto Learn Sensor).
2. Insert the batteries on the IQ Keypad to initiate pairing. If the batteries were previously installed, press and hold  for 3 seconds to initiate pairing instead.
3. The IQ Keypad will be recognized by the primary panel. Configure options accordingly then touch “Add New”.

NOTE: Upon tamper closure the keypad will calibrate the cap touch. This sequence takes 20 seconds, the installer shall refrain from using the keypad for the initial 10 seconds. If the keypad is not calibrated correctly keypresses might not be sensitive or detected. The keypad will continually calibrate itself when not in use and will optimize keypresses. If initial calibration was successful allow for the keypad to calibrate itself for initial 24H. The keypad may be used normally during this time.

NOTE: The IQ Keypad may also be manually paired to a panel by using the sensor ID printed on the device beginning with 372-XXXX. If manual learn is used instead of Auto Learn, you must network the device after pairing is complete by pressing and holding [*] for 3 seconds.

NOTE: At the compatible control panel, run a PowerG test to receive the signal strength of your keypad. You can view the average signal strength over 24 hours. Strength can be Strong, Good, Poor or No Signal. For UL/ULC and EN50131 Grade 2 installations, the strength shall be Strong for the location where the keypad is installed.

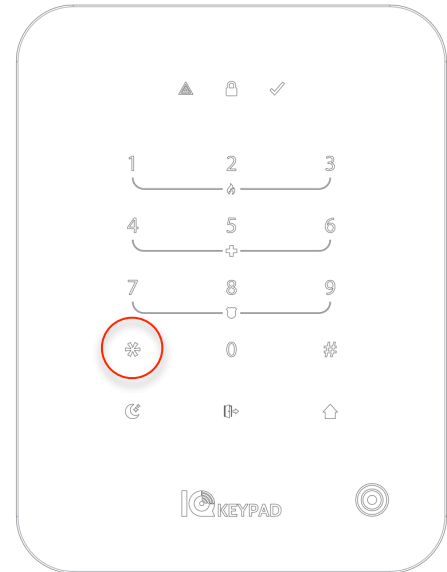

USER INTERFACE

WAKE THE IQ KEYPAD

Waking the IQ Keypad

To conserve battery, the IQ Keypad enters an idle state when not in use.

To wake the IQ Keypad, tap above the IQ Keypad logo. The IQ Keypad's LED backlight will illuminate and the device will be ready to use.

Touch HERE
to wake



4 5 6
+ —————

7 8 9
—————

* 0 #

☾ 🗑️ 🏠



 IQ KEYPAD



STATUS LIGHTS

KEYPAD STATUS LIGHTS:

Status lights help you understand the state of the system at a glance.



Status Lights	LED	Description
	OFF	Not ready to Arm.
	ON	Ready to Arm.
	FLASHING	Ready to Arm, bypass-able zones are open.
	OFF	Disarmed
	ON	Armed
	FLASHING (1/s)	Alarm condition
	RAPID FLASHING (2/s)	Alarm condition with bell silenced for Fire Alarms
	OFF	No Trouble
	ON	System Trouble
	FLASHING	Keypad Low Battery

NOTE: If RF Jam Trouble or Loss of Communication is detected, all LED's will flash in the following sequence: ON for 0.5s, then OFF for 0.5s - repeating 3x in a row, 2 second break, then start over. The user shall always check the IQ Keypad to assess the status of the system. The indications on the keypad are always active for the duration of the condition being present in the system, keypad can go to sleep mode to save battery life, wake up by pressing above IQ Keypad logo, the indications will be visible again to the end user. Viewing trouble details, acknowledging trouble conditions and arming override cannot be performed from IQ Keypad, but must be performed from the primary panel or app.

ARMING

ARMING KEYS:

Arming keys are the primary way of controlling the system from the IQ Keypad.

Key	Description
	Arm Stay
	Arm Away
	Arm Night



NOTE: If successful, the Armed Status LED will flash twice. If communication is not successful, the keypad flashes all keypad number LED's (backlight) 0.5 seconds ON/OFF twice.

NOTE: Press and hold any arming key for more than 2s for Silent Arm.

SECURE ARMING

SECURE ARMING:

When Secure Arming is enabled on the primary panel, a valid 4 - 6 digit users code is required to Arm the system.

Key	Description
	Arm Stay + [Access Code] or [Prox Tag]
	Arm Away + [Access Code] or [Prox Tag]
	Arm Night + [Access Code] or [Prox Tag]



PROX TAG SUPPORT:

For “IQ Keypad Prox-PG” models that support Prox Tags, you may Arm with a Prox Tag in place of a 4 - 6 digit code if Secure Arming is enabled and by pressing the Arming icon of choice, followed by presenting your tag in front of the bullseye icon on the lower right hand side of the keypad.

DISARMING

DISARMING KEYS:

Disarming from the IQ Keypad is easy. Simply enter a valid 4 - 6 digit code into the keypad and the system will disarm.

NOTE: If successful, the Armed Status LED will flash twice. If communication is not successful, the keypad flashes all keypad number LED's (backlight) 0.5 seconds ON/OFF twice.



PROX TAG SUPPORT:

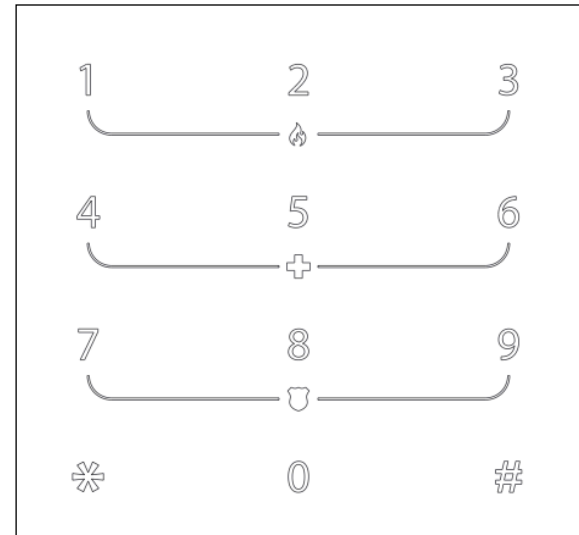

For "IQ Keypad Prox-PG" models that support Prox Tags, simply present your tag in front of the bullseye icon on the lower right hand side of the keypad and it will light up indicating the the tag has been read successfully. If the system is armed, presenting a valid Prox Tag will disarm it.



EMERGENCY KEYS

EMERGENCY KEYS:

Emergency keys allow you to trigger an emergency panic directly from the IQ Keypad.

Key	Description
	Press and hold both the 1 & 3 keys simultaneously to generate a fire alarm.
	Press and hold both the 4 & 6 keys simultaneously to generate an auxiliary emergency alarm.
	Press and hold both the 7 & 9 keys simultaneously to generate a police panic alarm.

NOTE: Press and hold emergency keys for 2 seconds.

NOTE: Note: When a Fire Alarm occurs (Temporal three pattern), the Bell sounding can be silenced by entering the valid user code. The "LOCK" indicator will start flashing rapidly (2/s) indicating that a fire alarm condition with bell silenced exists in the system. The Fire alarm will be reset only when the fire initiating device has been restored. The same functionality will also be for Carbon Monoxide alarms (Temporal four pattern). For Fire Alarms and CO Alarm always follow the evacuation plan as suggested in your alarm system manual. When a Burglary Alarm occurs (continuous pattern), the alarm can be reset by entering a valid user code.

STAR MENU



STAR MENU:

The Star Menu on the IQ Keypad allows access to more advanced functionality such as silent arming, bypassing zones, turning on/off the chime, buzzer and more. See table below for a list of functions

Press	Action
[*][0]	Starts keypad cleaning mode and lasts for 30 seconds. Alarms, entry and exit delay will cancel screen cleaning
[*][1] + [Access Code]	Bypass all open Zones <small>NOTE: feature no allowed to be used on UL/cUL installations</small>
[*][2] + [Access Code]	Silences Troubles
[*][4] + [Access Code]	Toggle Chime On/Off
[*][6] + [Access Code]	Toggle Keypress Buzzer On/Off
[*][7] + [Output #] + [Access Code]	Toggle Command Output (for future use)
[*][8] + [Access Code]	Turn on Installer Programming Access (EN Grade 2 only)
[*][9] + [Access Code]	Arm System with No Entry Delay

NOTE: All * menus will follow secure arming option whether an access code is needed or not

PARTITION ARMING



PARTITION ARMING:

The Hash Menu on the IQ Keypad allows access to Partition Arming functionality. It may also act as a “Home” button to back out of any button press activity and start over. See table below for a list of functions.

Press	Action
[#][1] + [Arm Stay] + [Access Code] or [Prox]	Arm Partition 1 to Stay
[#][2] + [Arm Stay] + [Access Code] or [Prox]	Arm Partition 2 to Stay
[#][3] + [Arm Stay] + [Access Code] or [Prox]	Arm Partition 3 to Stay
[#][4] + [Arm Stay] + [Access Code] or [Prox]	Arm Partition 4 to Stay
[#][1] + [Access Code] or [Prox]	Disarm Partition 1
Hold [#] for 2 Seconds	Erases any current button presses

MAINTENANCE

BATTERY REPLACEMENT

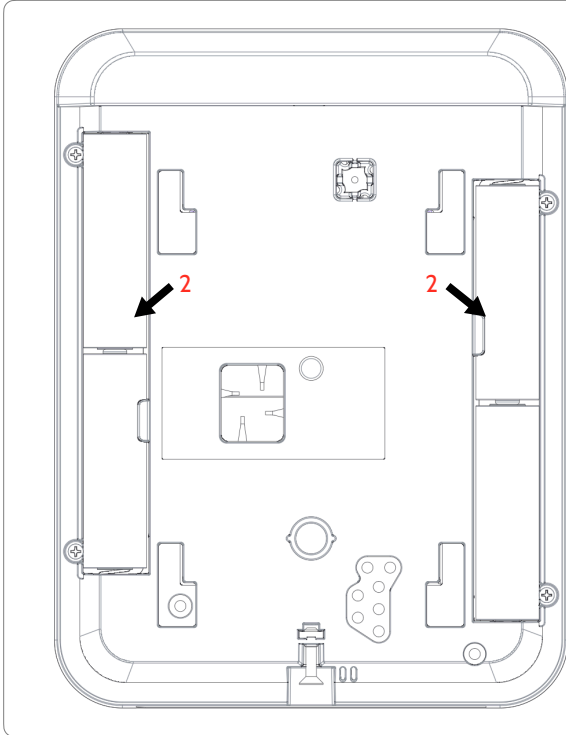

1. **Remove Keypad from Backplate:** Unscrew the bottom screw on the bottom of the keypad and then slide up to remove the keypad from the wall mount.
2. **Remove Batteries:** Remove the 4 x AA batteries from the back of the keypad. Do **NOT** use a screwdriver or anything sharp that could puncture the battery.
3. **Install New Batteries:** Insert new 4 x AA batteries into the battery slots. Be sure to observe polarity.
4. **Reinstall Keypad on Backplate:** Slide the keypad down onto the wall mount and secure with the bottom screw so that it can not be removed. Test and verify functionality with the primary panel.

NOTE: For UL/ULC applications, replace the batteries yearly.

Use only Energizer AA 1.5V ALKALINE BATTERY

CAUTION: Do **NOT** use a screwdriver or anything sharp that could puncture the battery.

LEGAL

UL/cUL RESIDENTIAL FIRE & BURGLARY INSTALLATIONS

This product has been tested and found in compliance with the following standards: UL1023 Household Burglar-Alarm System Units, UL985 Household Fire Warning System Units, ULC-S545 Residential Fire Warning Systems Control Units and ULC-S304 Security Level I Control Units, Accessories and Receiving Equipment for Intrusion Alarm Systems. For ULC Installations refer to the Standard for the Installation of Residential Fire Warning Systems, CAN/ULC-S540.

Wireless Supervision window at the control panel shall be set to 4 hours for UL/ULC Residential Fire Installations.

Wireless Supervision window at the control panel shall be set to 24 hours for Residential Burglary Installations only.

The keypads shall be installed in accordance with CSA C22.1, Canadian Electrical Code, Part I, Safety Standard for Electrical Installations; CAN/ULC S302, Standard for the Installation, Inspection and Testing of Intrusion Alarm Systems; and CAN/ULC S301, Standard for Signal Receiving Centre Intrusion Alarm Systems and Operations. Install only in dry, ordinary, indoor locations.

Test the system for operation upon completion of installation of the IQ Keypad.

Note: After completion of alarm system installation and zone assignments, the installer shall complete a list of protective zones used with description and place it underneath the keypad

UL/ULC COMMERCIAL BURGLARY INSTALLATIONS

This product has been tested and found in compliance with the following standards: UL2610 Central Station Burglar-Alarm Units and ULC-S304 Control Units, Accessories and Receiving Equipment for Intrusion Alarm Systems, Security Levels I-II.

Note: The product is not intended for installation outdoors or outside the protected premises.

This product is UL/ULC listed under the following categories: AMQE/AMCX7 Central Stations Alarm Units, UTOU/UTOU7 Control Units and Accessories, Household System Type NBSX/NBSX7 Household Burglar Alarm System Units. For further information on this product's listings please also refer to the official listing guides published at the UL website (www.ul.com) under Online Directory Section.

Programming:

The notes in the Installation Manual describing the system configurations for UL/uLC listed installations shall be implemented.

Note: For UL certified Commercial Burglary Central Station applications the IQ Keypad provides an acknowledgment signal to the user interface to confirm that normal closing signal has been received once the system has been armed. The device causes an audible indication (eight short beeps) when it receives the acknowledgment signal transmitted from the monitoring station compatible receiver.

UL/ULC COMMERCIAL BURGLARY INSTALLATIONS continued...

User Information:

- The installer should advise the user and note in the User's Manual
- Service organization name and telephone number
- The programmed exit and entry time
- Instructions to test system weekly
- Note that the installer code cannot arm or disarm the system
- The installer should caution the user not to give system information (e.g., codes, bypass methods, etc.) to casual users (e.g., service people) and to only give out codes set to expire within 24 hours
- Identification of the conditions that might be expected to result in false alarms or impaired operation of the product(s): arming the system and not respecting the exit delay, entering the protected premises and not respecting the entry delay for disarming the system can cause false alarms.

FCC & ISED CANADA COMPLIANCE STATEMENT

This Class [B] digital apparatus meets all requirements of the Canadian Interference-Causing Equipment Regulations.

Cet appareil numérique de la classe [B] respecte toutes les exigences du Règlement sur le matériel brouilleur du Canada.

IMPORTANT! Changes or modifications not expressly approved by Qolsys Inc. could void the user's authority to operate the equipment.

CAUTION! This equipment complies with radiation exposure limits set forth for uncontrolled environment. The antenna(s) used for this transmitters must be installed to provide a separation distance of at least 20 cm from all persons and must not be collocated or operating in conjunction with any other antenna or transmitter.

This device complies with Part 15 of the FCC Rules. Operation is subject to the following two conditions: (1) this device may not cause harmful interference, and (2) this device must accept any interference received, including interference that may cause undesired operation.

FCC & ISED CANADA COMPLIANCE STATEMENT continued...

This equipment has been tested and found to comply with the limits for a Class B digital device, pursuant to part 15 of the FCC Rules. These limits are designed to provide reasonable protection against harmful interference in a residential installation. This equipment generates, uses and can radiate radio frequency energy and, if not installed and used in accordance with the instructions, may cause harmful interference to radio communications. However, there is no guarantee that interference will not occur in a particular installation. If this equipment does cause harmful interference to radio or television reception, which can be determined by turning the equipment off and on, the user is encouraged to try to correct the interference by one or more of the following measures:

- Reorient or relocate the receiving antenna.
- Increase the separation between the equipment and receiver.
- Connect the equipment into an outlet on a circuit different from that to which the receiver is connected.
- Consult the dealer or an experienced radio/TV technician for help.

CE & EN COMPLIANCE STATEMENT

Hereby, Qolsys Inc declares that the radio equipment type is in compliance with Directive 2014/53/EU.

The full text of the EU declaration of conformity is available at the following internet address:

IQ Keypad - PG: <http://dsc.com/2405002>

IQ Keypad Prox - PG: <http://dsc.com/2405001>

Frequency band and Maximum Power

433,22 MHz - 434,62 MHz: 10mW

869.0 MHz - 868.6 MHz: 17.2mW

868,7 MHz - 869,2 MHz: 17.2mW

119 KHz - 135 KHz: 2.61db μ A/m @ 3 m

European single point of contact: Tyco Safety Products, Voltaweg 20, 6101XK Echt, Netherlands.

This installation sheet applies to models IQ Keypad - PG and IQ Keypad Prox - PG.

The Model IQ Keypad - PG and IQ Keypad Prox - PG keypads have been certified by Kiwa Nederland BV according to EN50131-1:2006+ A1:2009 + A2:2017+A3:2020, EN50131-3:2009 for Grade 2, Class II.

Caution: Do not dispose of the waste battery as unsorted municipal waste. Consult your local rules and/or laws regarding recycling of this battery.

SPECIFICATIONS

SPECIFICATIONS



Items	Parameters	IQ Keypad
Interface	Type	Capacitive touch key mat (0-9, *, #, Arm Stay, Arm Away, Arm Night keys)
Wireless	Security R/F	PowerG 912- 919MHz, 868MHz, 433MHz. UL listed models only operate in 912-919MHz band
LED Indicator	Status LEDs	Trouble, Arming, Status
Buzzer		1x for key presses, chirps and alarms
Tamper	Tamper Switch	Wall and Enclosure Tamper
Battery	Type	4 x AA - Use only Energizer AA 1.5V ALKALINE BATTERY
	Current Draw	Minimum: 28 μ A (during sleep mode); Maximum: 44mA (during alarm mode)
	Low Battery Indication	4.4 volts
Mechanical	Dimension	6.1"H x 4.6"W x .91"D (155mm x 117mm x 23mm)
Weight		320 grams (batteries included)
Mount	Back Plate	Wall mount only
Certification	UL/cUL/ULC	UL/cUL Residential Fire and Burglary and UL/ULC Commercial Burglary Alarm Control Unit. Compliant with standards: UL985, UL1023, UL2610, ULC-S545, ULC-S304
	FCC/IC	FCC ID: 2AAJXQS-IQKP IC: 11205A-QSIQKP
Temperature	Operational	-10 to 55C, up to 93% relative humidity, indoor, dry ordinary locations use only (*)
	Storage	-40 to 85C, up to 95% relative humidity, indoor, dry ordinary locations only (*)

(*) Note: UL has only verified operation in OC - 49C and up to 93%RH

Johnson Controls



Qolsys Inc. proprietary.
Reproduction without permission is not permitted.

Document#: IQKPPG-IM-06-24
Revision Date: 06/07/24